



ZCASE Single Mega/Starter Fuse

## ZCASE Single MEGA/Starter Fuse

The Single ZCASE is a Minimal Footprint Bolt Down Fuse with a wide rating range up to 600A in the same packaging size. The Time Current characteristic is similar to the well known MEGA Design and can be used as full wire protection until 250A. Higher ratings mostly used for typically Starter Fuse application as a protector fuse. The fuse design is optimized for a one bolt connection M6 (40A - 250A) or M8 (300A - 600A) and can be used directly on a battery post or busbar connection. Littelfuse is offering a complete solution for the necessary stud and different busbar connections including some battery clamps.

### Specifications

Voltage Rating:	32V DC
Interrupting Rating:	2000A @ 32V VDC
Recommended Environmental Temperature:	-40 to 125°C
Terminal Material:	Tin plated Copper
Housing Material:	PPA-GF33HS (U.L. 94 Flammability rating - HB)
Insulating Tube:	Out of ceramic
Mounting Torque M6:	9.8Nm±1.4Nm
Mounting Torque M8:	14Nm±2Nm

### Time-Current Characteristic Curves

See note on next page regarding Test Set-Up

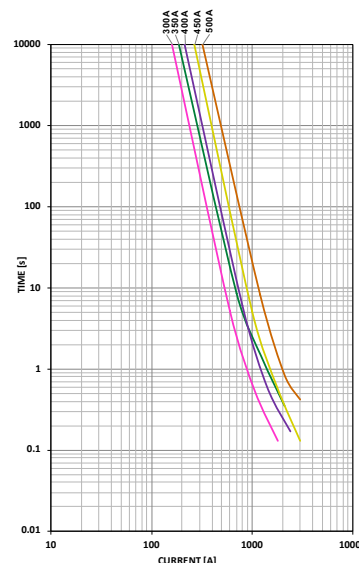
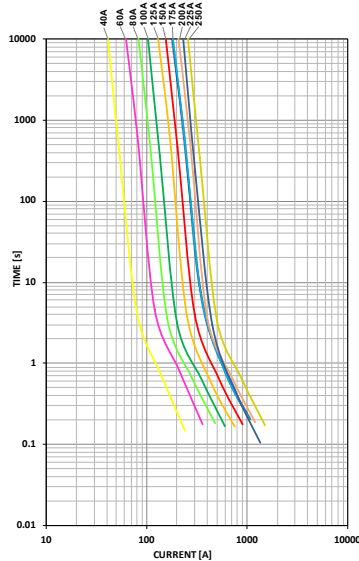

### Ordering Information

Part Number	Rating	Package Size
3298XXX.ZXSTA	300 - 600	480
3298XXX.Z	40 - 250 SHUNT	480
3298XXX.H	40 - 600	100

### Time-Current Characteristics

% of Rating	Opening Time Min / Max (s)		
	40A - 250A	300A - 500A	600A
50	- / -	14,400 / ∞	14,400 / ∞
100	14,400 / ∞	- / -	- / -
135	120 / 1800	- / -	- / -
200	1 / 15	1 / 40	1 / 40
350	0.3 / 5	0.3 / 5	0.3 / 5
500	- / -	- / -	0.1 / 1
600	0.1 / 1	0.1 / 1	- / -

### Ratings

Part number	Current Rating (A)	Test Cable Size (mm <sup>2</sup> )	Typ. Voltage Drop (mV)	Typ. Cold Resistance (mΩ)	Typ. I <sup>2</sup> t (A <sup>2</sup> s)
3298040.Z / 3298040.H	40	4	86	1.53	5,000
3298060.Z / 3298060.H	60	6	83	0.98	18,000
3298080.Z / 3298080.H	80	10	80	0.72	15,500
3298100.Z / 3298100.H	100	16	88	0.57	31,000
3298125.Z / 3298125.H	125	16	71	0.39	45,000
3298150.Z / 3298150.H	150	25	83	0.32	75,000
3298175.Z / 3298175.H	175	25	82	0.26	140,000
3298200.Z / 3298200.H	200	35	92	0.23	235,000
3298225.Z / 3298225.H	225	35	86	0.18	95,000
3298250.Z / 3298250.H	250	50	88	0.17	160,000
3298300.ZXSTA / 3298300.H	300 <sup>1</sup>	35	29 <sup>2</sup>	0.13	310,000
3298350.ZXSTA / 3298350.H	350 <sup>1</sup>	35	30 <sup>2</sup>	0.10	570,000
3298400.ZXSTA / 3298400.H	400 <sup>1</sup>	50	30 <sup>2</sup>	0.08	870,000
3298500.ZXSTA / 3298500.H	500 <sup>1</sup>	50	34 <sup>2</sup>	0.07	1,550,000
3298600.ZXSTA / 3298600.H	600 <sup>1</sup>	50	36 <sup>2</sup>	0.05	3,000,000
3298900.Z /	SHUNT	50	-	-	-

Note 1 STARTER fuses

Note 2 Voltage Drop taken at 50% of Rated Current

The typical I<sup>2</sup>t is an average value calculated from the breaking capacity tests by using the melting time before the arcing occurs.

REV07272021

Littelfuse® products are not designed for, and shall not be used for, any purpose (including, without limitation, automotive, military, aerospace, medical, life-saving, life-sustaining or nuclear facility applications, devices intended for surgical implant into the body, or any other application in which the failure or lack of desired operation of the product may result in personal injury, death, or property damage) other than those expressly set forth in applicable Littelfuse® product documentation. Warranties granted by Littelfuse® shall be deemed void for products used for any purpose not expressly set forth in applicable Littelfuse® documentation. Littelfuse® shall not be liable for any claims or damages arising out of products used in applications not expressly intended by Littelfuse® as set forth in applicable Littelfuse® documentation. The sale and use of Littelfuse® products is subject to Littelfuse Terms and Conditions of Sale, unless otherwise agreed by Littelfuse®.

## ZCASE Single Mega/Starter Fuse

### Dimensions

Dimensions in mm for reference only.  
See outline drawing for dimensions and tolerances.

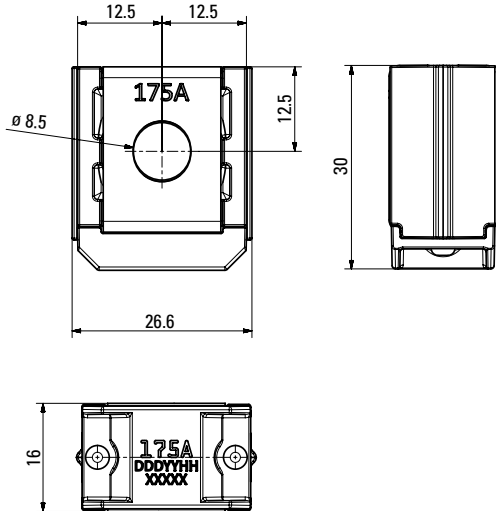

## Assembly Components (sold separately)

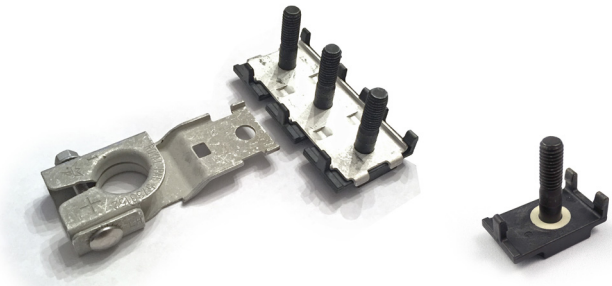

Part No.	Description
882-853	3-Way Bus Bar with M8 Insulating Bolts Assembly*
882-854	2-Way Bus Bar with M8 Insulating Bolts Assembly*
876-199	Battery Terminal Mount
32980001ZXM8	M8 Insulating Bolt

\*M8 Nuts not included

Please contact your Littelfuse representative for application support and information on mating hardware.

### Typical Derating of Fuse Melting Element

Temperature Security Margin is 20%  
Please contact Littelfuse® for Details Regarding Derating Test Set-Up.

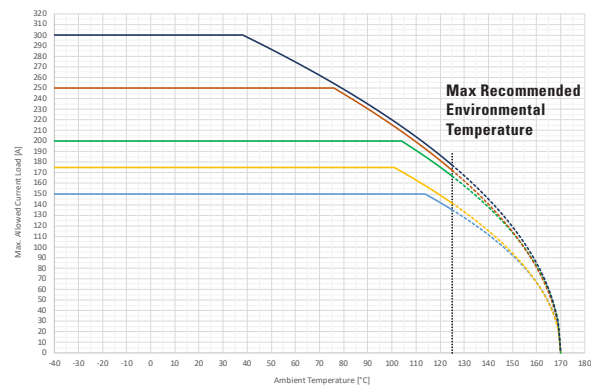
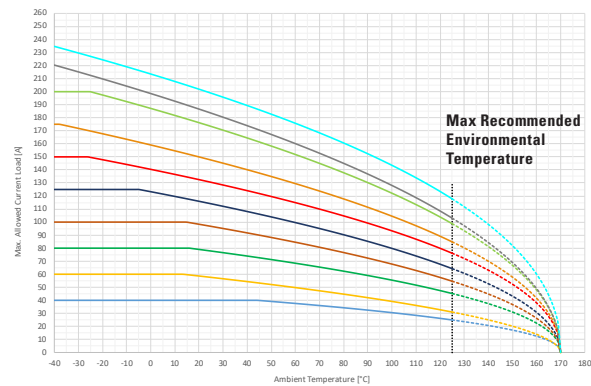

### Temperature Table

	max. allowed current load [A] at ambient temperature						
	-20°C	0°C	20°C	65°C	85°C	110°C	125°C
<b>40A</b>	40	40	40	37	33	28	25
<b>60A</b>	60	60	59	49	43	36	31
<b>80A</b>	80	80	79	67	61	52	45
<b>100A</b>	100	100	98	83	75	63	55
<b>125A</b>	125	123	116	97	88	74	64
<b>150A</b>	150	140	133	112	102	87	76
<b>175A</b>	175	159	150	127	115	97	85
<b>200A</b>	200	187	176	148	134	113	99
<b>225A</b>	220	199	187	157	141	119	103
<b>250A</b>	235	214	202	172	157	134	118
<b>300A</b>	150	150	150	150	150	150	135
<b>350A</b>	175	175	175	175	175	163	141
<b>400A</b>	200	200	200	200	200	191	167
<b>500A</b>	250	250	250	250	238	199	172
<b>600A</b>	300	300	300	268	242	204	177

All tests were performed on the left or right side of the metal bar as shown in the pictures. A 50mm<sup>2</sup> Cu wire was mounted at the mid hole (M8) as current feed.

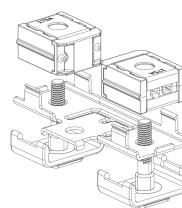

Zcase Mega Fixture

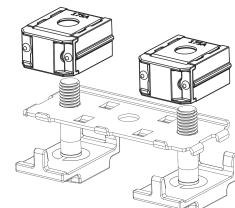

Zcase Starter Fixture

Derating curves may change depending on the final condition of the application (terminals characteristics, wire size etc.).  
Please ask Littelfuse for more information.

REV07272021

Littelfuse® products are not designed for, and shall not be used for, any purpose (including, without limitation, automotive, military, aerospace, medical, life-saving, life-sustaining or nuclear facility applications, devices intended for surgical implant into the body, or any other application in which the failure or lack of desired operation of the product may result in personal injury, death, or property damage) other than those expressly set forth in applicable Littelfuse® product documentation. Warranties granted by Littelfuse® shall be deemed void for products used for any purpose not expressly set forth in applicable Littelfuse® documentation. Littelfuse® shall not be liable for any claims or damages arising out of products used in applications not expressly intended by Littelfuse® as set forth in applicable Littelfuse® documentation. The sale and use of Littelfuse® products is subject to Littelfuse Terms and Conditions of Sale, unless otherwise agreed by Littelfuse®.

## X-ON Electronics

Largest Supplier of Electrical and Electronic Components

*Click to view similar products for [Automotive Fuses](#) category:*

*Click to view products by [Littelfuse](#) manufacturer:*

Other Similar products are found below :

[ATM-4LP](#) [AFX-50](#) [299080](#) [0287015](#) [FMM-15](#) [0297003.WXT](#) [0695060.PXPS](#) [MRBF-075](#) [MRBF-300](#) [MRBF-200](#) [ANX80-UL-20A](#)  
[ANX80-UL-25A](#) [ANX80-UL-30A](#) [ANX80-UL-35A](#) [ANX80-UL-40A](#) [ANT-I-3A](#) [APM-I-25A](#) [APR-10A](#) [APR-25A](#) [ANX58-UL-20A](#)  
[ANX58-UL-25A](#) [ANX58-UL-35A](#) [ANX58-UL-40A](#) [ANX58-UL-50A](#) [ANM-4A](#) [ANM-25A](#) [ANE-175A](#) [APM-25A](#) [APM-4A](#) [ACB2-PL-](#)  
[15A](#) [ACB2-PL-25A](#) [ANM58-15A](#) [ANM58-5A](#) [MIDA-50A](#) [0695040.PXP](#) [0327030.YX2T](#) [0298500.UX1M8](#) [0299070.ZXT](#) [ATM-1](#) [MRBF-](#)  
[040](#) [MRBF-250](#) [MRBF-050](#) [MRBF-060](#) [CFCOVER-2R](#) [MRBF-030](#) [3298600.ZXM10](#) [AMG-80](#) [FLG-80](#) [BK-AMG-225](#) [BK/FMM-15](#)