

55505 Hall Effect Flange Mount Geartooth Speed Sensor

RoHS



Dimensions

Dimensions in mm (inch)

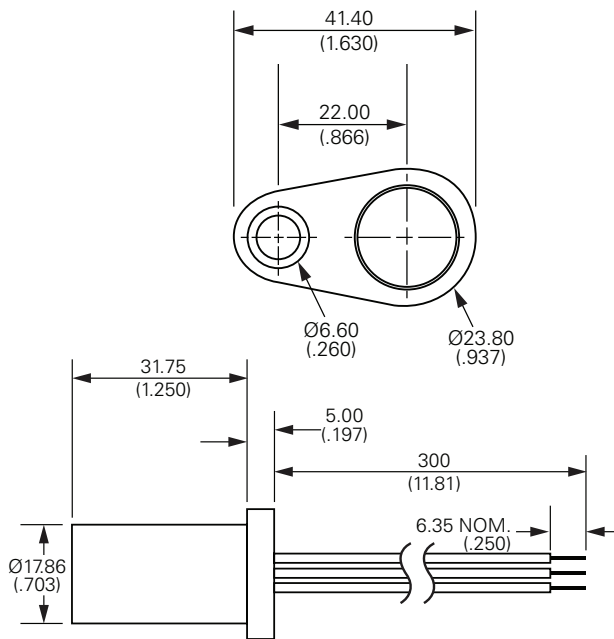

Block Diagram

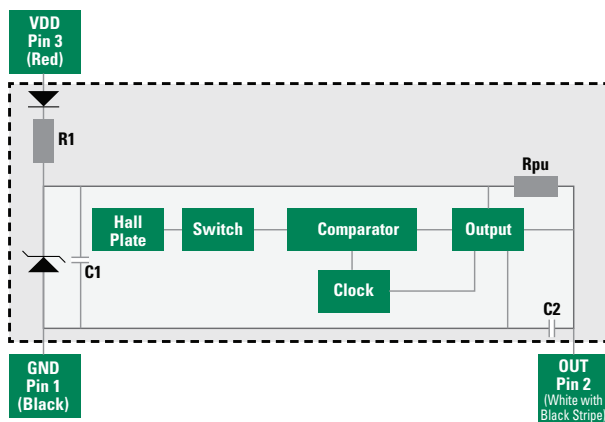

Description

The 55505 is a robust flange mounting hall effect sensor primarily for geartooth speed sensing. Protected against severe and automotive environments. It is capable of switching up to 27Vdc and 20mA and available as three-wire (voltage output) version. Its case design incorporates brass mounting bush. It is ideally suited to wheel, transmission and camshaft speed sensing, geartooth sensor, rotary encoders, industrial, commercial, and automotive applications.

Features

- Ferrous target speed sensing
- Internal circuit protection
- Protection against severe and automotive environments
- Self adjusting magnetic range
- Automotive grade circuit protection
- High speed operation
- Short circuit and reverse voltage protection
- On board 10-bit A/D convertor

Benefits

- No chopper delay
- Immune to target run out
- Rotational alignment to target not critical

Applications

- Wheel, transmission and camshaft speed sensing
- Geartooth sensor
- Rotary encoders
- Industrial
- Commercial
- Automotive

Application Example (Geartooth Sensor)

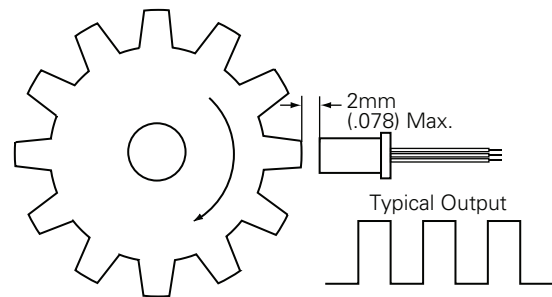

55505 Hall Effect Flange Mount Geartooth Speed Sensor

Electrical Ratings

| Hall Type | | Digital Switch 3-Wire (Voltage Output) | |
|--|---|---|---|
| Supply Voltage ¹ | Operate Overvoltage Protection Reverse Voltage Protection | Vdc Vdc - max. Vdc - max. | 4.75 to 24 27 -25 |
| Output High Voltage | | Vdc - min. | VDD -2 (-2 sinking output with internal pull-up) |
| Output Low Voltage | | Vdc - max. | 0.6 @ 20mA |
| Output Current (continuously on) Current Consumption Current Consumption | | mA - max. mA - max. mA - max. | 20 1 10.5 |
| Current Consumption | | mA - min. mA - max. | 1 10.5 |
| Switching Speed | | KHz-max. | 15 |
| Temperature | Operating | °C | -40 to +125 |



Note:

1. As long as Tj (Junction Temperature) is not exceeded.

Cable Length Options

| Cable Type: 20AWG 7/28 TXL 125C SAE J1128 | |
|---|---------------------------|
| Select Option | Cable Length mm (inch) |
| 02 | 300 (11.81) |

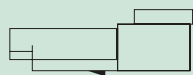
Termination Options

| Select Option | Description | |
|---------------|------------------|---|
| A | Tinned Leads |  |
| B | Deutsch DTM04-3P |  |
| C | Molex MX 150 |  |

Part Numbering System

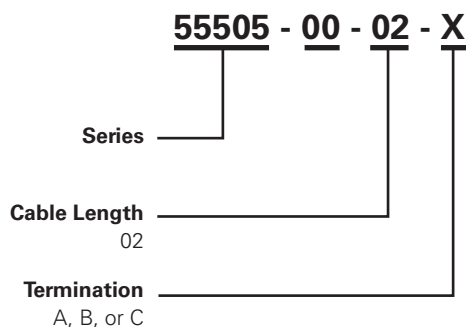

Packaging

| Packaging Option | Packaging Specification | Quantity | Quantity & Packaging Code | Taping Width |
|------------------|-------------------------|----------|---------------------------|--------------|
| Bulk | Bulk | 500 | N/A | N/A |

X-ON Electronics

Largest Supplier of Electrical and Electronic Components

Click to view similar products for [Industrial Hall Effect/Magnetic Sensors](#) category:

Click to view products by [Littelfuse](#) manufacturer:

Other Similar products are found below :

[GT-13013](#) [GT-13040](#) [GT-14114](#) [GT-14123](#) [SR4P2-C7](#) [GT-12076](#) [GT-13012](#) [GT-14049](#) [GT-14067](#) [GT-14132](#) [GT-18030](#) [103FW12-R3](#)
[SMSA2P30CG](#) [GN 55.2-SC-8-3](#) [MZR40178](#) [103FW41-R1](#) [SR-10018](#) [PST360G2-1S-C0000-ERA360-05K](#) [HMR3300](#) [103SR14A-1](#) [MZT7-03VPS-KR0](#) [MZT7-03VPS-KW0](#) [MZT8-03VPS-KW0](#) [MZT8-28VPS-KP0](#) [GN 55.2-ND-15-3](#) [GN 55.2-ND-18-3](#) [GN 55.2-ND-4-3](#) [GN 55.2-ND-8-3](#) [GN 55.2-SC-10-3](#) [GN 55.4-ND-10-7,5-2](#) [GN 55.4-ND-12-9,5-2,5](#) [GN 55.4-ND-26-20,3-5](#) [GN 55.4-ND-7,5-4-1,5](#) [101MG7-BP](#)
[A1389LUA-9-T](#) [A1233LK-T](#) [MXM1120KIT](#) [MXM1120SOKIT](#) [A1220LLHLT-T](#) [AA004-00E](#) [AA006-02E](#) [MM12-60APS-ZUK](#) [ACX04-F99-I-V15](#) [GN 55.1-SC-24-11.5-4](#) [MZA70155](#) [MZR40158](#) [PW520000](#) [ADH025-00E](#) [HMR2300-D00-485](#) [RZT7-03ZRS-KP0](#)