

# 59030 Miniature Firecracker Reed Sensor + 57030 Actuator



## Description

The 59030 is a miniature cylindrical reed sensor 38.1mm (L) x 6.22mm (Dia) (1.50" x 0.245") with a choice of normally open, normally closed, and change-over contacts. It is capable of switching up to 265Vac/300Vdc at 10VA. It functions best with the 57030-000 actuator.

**Note: The 57030 Actuator is sold separately.**

## Features

- Two-part magnetically operated proximity sensor
- Hermetically sealed contacts
- Operates through non-ferrous materials such as wood, plastic or aluminum
- Customer defined sensitivity option
- Choice of cable length and connector

## Agency Approvals

Agency	Agency File Number
	E61760

Note: Contact Littelfuse for specific agency approval ratings.

## Benefits

- Well suited for usage in high-moisture and contaminated environments
- Non-contact solution, aesthetically more appealing than push-button or lever mechanical-type switches
- Ideal for battery-powered applications as the contacts do not draw power when in the non-activated state
- Reed contacts last for millions of operating cycles under micro-controller logic level loads

## Dimensions

Dimensions in mm (inch)

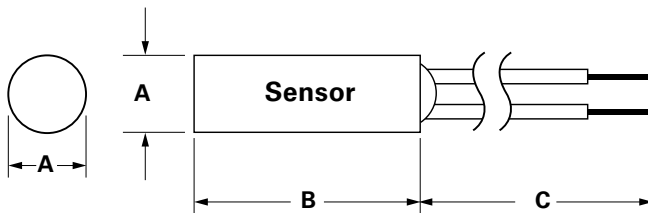

	A Nom. mm(inch)	B Nom. mm(inch)	C Nom. mm(inch)
<b>57030 Actuator</b>	6.22 (.245)	38.10 (1.50)	—
<b>59030 Sensor</b>	6.22 (.245)	38.10 (1.50)	Cable Length ± 10.00 (.393)

## Applications

- Position and Limit Sensing
- Security Systems
- Level Sensing
- Linear Actuators

# 59030 Miniature Firecracker Reed Sensor + 57030 Actuator

## Electrical Ratings

Contact Type			Normally Open	Normally Open High Voltage	Change Over	Normally Closed
Switch Type			1	2	3	4
Contact Rating <sup>1</sup>		VA/Watt - max.	10	10	5	5
Voltage <sup>4</sup>	Switching <sup>2</sup>	Vdc - max.	200	300	175	175
		Vac - max.	140	265	120	120
	Breakdown <sup>3</sup>	Vdc - min.	250	400	200	200
Current <sup>4</sup>	Switching <sup>2</sup>	Adc - max.	0.5	0.4	0.25	0.25
		Aac - max.	0.35	0.30	0.18	0.18
	Carry	Adc - max.	1.2	1.4	1.5	1.5
Resistance <sup>5</sup>	Contact, Initial Insulation	Ω - max.	0.2	0.2	0.2	0.2
		Ω - min.	10 <sup>10</sup>	10 <sup>10</sup>	10 <sup>9</sup>	10 <sup>9</sup>
Capacitance	Contact	pF - typ.	0.3	0.2	0.3	0.3
Temperature	Operating	°C	-40 to +105	-20 to +105	-40 to +105	-40 to +105

## Product Characteristics

Operate Time <sup>6</sup>		ms - max.	1.0	1.0	3.0	3.0
Release Time <sup>6</sup>		ms - max.	1.0	1.0	3.0	3.0
Shock <sup>7</sup>	11ms ½ sine	G - max.	100	100	50	50
Vibration <sup>7</sup>	50-2000 Hz	G - max.	30	30	30	30

**Notes:**

- Contact rating - Product of the switching voltage and current should never exceed the wattage rating. Contact Littelfuse for additional load/life information.
- When switching inductive and/or capacitive loads, the effects of transient voltages and/or currents should be considered. Refer to Application Notes AN108A and AN107 for details.
- Breakdown Voltage - per MIL-STD-202, Method 301.
- Electrical Load Life Expectancy - Contact Littelfuse with voltage, current values along with type of load.
- This resistance value is for 11.81mm wire length. Resistance changes when wire lengthens.
- Operate (including bounce)/Release Time - per EIA/NARM RS-421-A, diode suppressed coil (Coil II).
- Shock and Vibration - per EIA/NARM RS-421-A and MIL-STD-202.
- For custom modifications to the wire length or size, or adding a special connector, please contact Littelfuse.

## Sensitivity Options (Using 57030 Actuator)

Select Option		S		T		U		V	
Switch Type	Pull-In AT Range	Activate Distance-D mm (inch) Average	Pull-In AT Range	Activate Distance-D mm (inch) Average	Pull-In AT Range	Activate Distance-D mm (inch) Average	Pull-In AT Range	Activate Distance-D mm (inch) Average	
1	Normally Open	12-18	8.4 (.330)	17-23	6.6 (.260)	22-28	5.1 (.200)	27-33	4.0 (.157)
2	High Voltage	--	--	17-23	6.6 (.260)	22-28	5.1 (.200)	27-33	4.0 (.157)
3	Change Over	15-20	6.5 (.255)	20-25	4.9 (.193)	25-30	3.7 (.146)	--	--
4	Normally Closed	15-20	6.5 (.255)	20-25	4.9 (.193)	25-30	3.7 (.146)	--	--

**Note:**

- Pull-In AT Range: These AT values are the bare reed switch AT before modification.
- The activation distance is average value on the final sensor assembly.

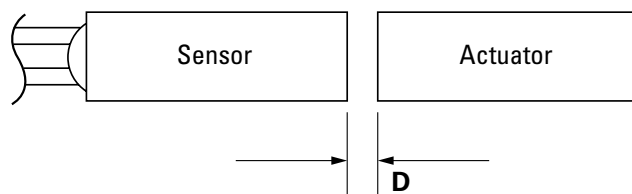

Schematics	Switch Type
	1 and 2
	3
	4

# 59030 Miniature Firecracker Reed Sensor + 57030 Actuator



## Cable Length Specification

**Cable Type: 24 AWG 7/32 PVC 105°C UL1430/UL1569**

Select Option	Cable Length mm (inch)
02	300 (11.81)

## Termination Specification

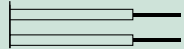
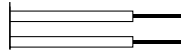
### Termination Options

Select Option	Description (Two-wire versions illustrated)	
A	Tinned leads (6.4±0.76)mm	
F	Untinned leads (6.4±0.76)mm	
E	JST type XHP 2.5mm pitch	

## Part Numbering System

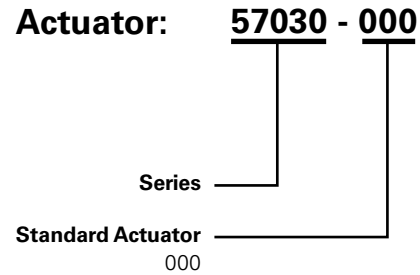
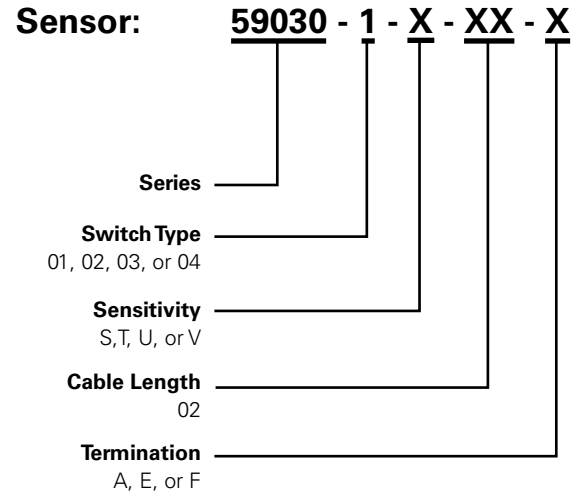

**Note: The 57030 Actuator is sold separately.**

## Packaging

Packaging Option	Packaging Specification	Quantity	Quantity & Packaging Code	Taping Width
Bulk	Bulk	500	N/A	N/A

**Disclaimer Notice** - Information furnished is believed to be accurate and reliable. However, users should independently evaluate the suitability of and test each product selected for their own applications. Littelfuse products are not designed for, and may not be used in, all applications. Read complete Disclaimer Notice at <http://www.littelfuse.com/disclaimer-electronics>.

## X-ON Electronics

Largest Supplier of Electrical and Electronic Components

*Click to view similar products for [Proximity Sensors](#) category:*

*Click to view products by [Littelfuse](#) manufacturer:*

Other Similar products are found below :

[01.001.5653.1](#) [70.340.1028.0](#) [70.360.2428.0](#) [70.364.4828.0](#) [70.810.1053.0](#) [72.360.1628.0](#) [73.363.6428.0](#) [8027AL20NL2CPXX](#) [FYCC8E1-2](#)  
[9221350022](#) [922AA2W-A9P-L](#) [PLS2](#) [GL-12F-C2.5X10\(LOT3\)](#) [972AB2XM-A3N-L](#) [972AB3XM-A3P-L](#) [PS3251](#) [980659-1](#) [QT-12](#) [E2E2-](#)  
[X5M41-M4](#) [E2E-X14MD1-G](#) [E2E-X2D1-G](#) [E2EX2ME2N](#) [E2EX3D1SM1N](#) [E2E-X4MD1-G](#) [E2E-X5E1-5M-N](#) [E2E-X5Y2-N](#) [E2E-X7D1-](#)  
[M1J-T-0.3M-N](#) [E2FMX1R5D12M](#) [E2K-F10MC1](#) [5M](#) [EH-302](#) [EI3010TBOP](#) [EI5515NPAP](#) [MS605AU](#) [EP175-32000](#) [BSA-08-25-08](#)  
[IFRM04N35B1/L](#) [IFRM04P1513/S35L](#) [IFRM06P1703/S35L](#) [IFRM08P1501/S35L](#) [IFRM12N17G3/L](#) [IFRM12P17G3/L](#) [IFRM12P3502/L](#)  
[IFRM12P37G1/S14L](#) [ILFK12E9189/I02](#) [ILFK12E9193/I02](#) [IMM2582C](#) [OISN-013](#) [25.161.3253.0](#) [25.332.0653.1](#) [25.352.0653.0](#)