

POWR-SPEED® Fuse

CLASS CC/CD CCMR SERIES FUSES

POWR-PRO® 600 V ac • Dual Element • Time-Delay • 2/10-60 A



Description

The CCMR series is ideal for space saving protection of motors up to 40 hp*. It was designed specifically to withstand sustained starting currents of small motors. The CCMR 60 fuse is the smallest 60 A fuse available rated at 600 V. Compared to other UL Listed fuses, Class CC fuses are the most current-limiting, rating for rating.

Features/Benefits

- POWR-PRO® Performance
- Extremely current-limiting
- Ratings up to 60 Amps
- 300 kA Interrupting Rating (self-certified)

Applications

- Motor and motor branch circuit protection

Dimensions Inches (mm)

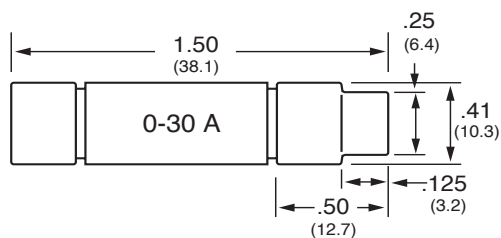

Specifications

Voltage Rating

Ac: 600 V
 Dc: 250 V (CCMR 2/10– 2 A)
 (CCMR 41/2– 10 A)
 (CCMR 35– 60 A)
 300 V (CCMR 21/4– 4 A)
 500 V (CCMR 12– 30 A)

Amperage Rating Interrupting Rating

2/10 – 60 A
 Ac: 200 kA rms symmetrical
 300 kA Littelfuse self-certified
 Dc: 20 kA

Approvals

Ac: Standard 248-4, Class CC
 UL Listed 2/10-30 A (File: E81895)
 Standard 248-18, Class CD
 UL Listed 35-60 A (File: E81895)
 CSA Certified (File: LR29862)

Environmental Country of Origin

Dc: Littelfuse self-certified
 RoHS Compliant (except 35-60 A)
 Mexico

Ordering Part Number

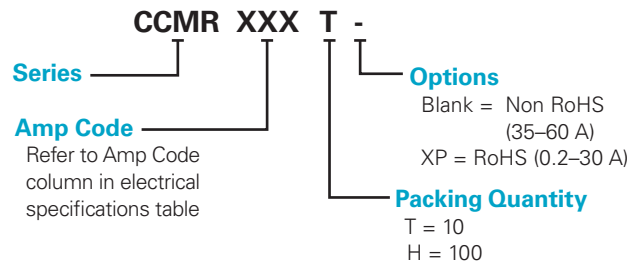

Web Resources

TC Curves, downloadable CAD drawings and other technical information: Littelfuse.com/ccmr

Recommended Fuse Holders

- LFC600 Series
- L60030C Series
- LPSC Touch-Safe Series (2/10-30A Only)
- 571/572 Panel Mount Series (2/10-30A Only)

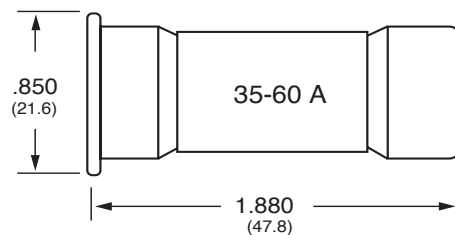

*Consult Motor Protection Tables on www.littelfuse.com or call 800-TEC-FUSE for specific motor sizing information.

POWR-SPEED® Fuse

CLASS CC/CD CCMR SERIES FUSES

Ordering Information

AMPERE	AMPERE CODE	CATALOG NUMBER	PRODUCT MARKING	PACK QUANTITY	ORDERING NUMBER	UPC
0.2	.200	CCMR.200	CCMR 2/10A	10	CCMR.200TXP	07945896805
				100	CCMR.200HXP	07945896841
0.25	.250	CCMR.250	CCMR ¼A	10	CCMR.250TXP	07945896806
				100	CCMR.250HXP	07945896842
0.3	.300	CCMR.300	CCMR 3/10A	10	CCMR.300TXP	07945896807
				100	CCMR.300HXP	07945896843
0.5	.500	CCMR.500	CCMR ½A	10	CCMR.500TXP	07945896808
				100	CCMR.500HXP	07945896844
0.6	.600	CCMR.600	CCMR 6/10A	10	CCMR.600TXP	07945896809
				100	CCMR.600HXP	07945896845
0.8	.800	CCMR.800	CCMR 8/10A	10	CCMR.800TXP	07945896810
				100	CCMR.800HXP	07945896846
1	001	CCMR001	CCMR 1A	10	CCMR001.TXP	07945896811
				100	CCMR001.HXP	07945896847
1.25	1.25	CCMR1.25	CCMR 1-¼A	10	CCMR1.25TXP	07945896812
				100	CCMR1.25HXP	07945896848
1.4	01.4	CCMR01.4	CCMR 1-4/10A	10	CCMR01.4TXP	07945896813
				100	CCMR01.4HXP	07945896849
1.5	01.5	CCMR01.5	CCMR 1-½A	10	CCMR01.5TXP	07945896814
				100	CCMR01.5HXP	07945896850
1.6	01.6	CCMR01.6	CCMR 1-6/10A	10	CCMR01.6TXP	07945896815
				100	CCMR01.6HXP	07945896851
1.8	01.8	CCMR01.8	CCMR 1-8/10A	10	CCMR01.8TXP	07945896816
				100	CCMR01.8HXP	07945896852
2	002	CCMR002	CCMR 2A	10	CCMR002.TXP	07945896817
				100	CCMR002.HXP	07945896853
2.25	2.25	CCMR2.25	CCMR 2-¼A	10	CCMR2.25TXP	07945896818
				100	CCMR2.25HXP	07945896854
2.8	02.8	CCMR02.8	CCMR 2-8/10A	10	CCMR02.8TXP	07945896820
				100	CCMR02.8HXP	07945896856
3	003	CCMR003	CCMR 3A	10	CCMR003.TXP	07945896821
				100	CCMR003.HXP	07945896857
3.2	03.2	CCMR03.2	CCMR 3-2/10A	10	CCMR03.2TXP	07945896822
				100	CCMR03.2HXP	07945896858
3.5	03.5	CCMR03.5	CCMR 3-½A	10	CCMR03.5TXP	07945896823
				100	CCMR03.5HXP	07945896859
4	004	CCMR004	CCMR 4A	10	CCMR004.TXP	07945896824
				100	CCMR004.HXP	07945896860
4.5	04.5	CCMR04.5	CCMR 4-½A	10	CCMR04.5TXP	7945896825
				100	CCMR04.5HXP	7945896861
5	005	CCMR005	CCMR 5A	10	CCMR005.TXP	07945896826
				100	CCMR005.HXP	07945896862
5.6	05.6	CCMR05.6	CCMR 5-6/10A	10	CCMR05.6TXP	07945896827
				100	CCMR05.6HXP	07945896863
6	006	CCMR006	CCMR 6A	10	CCMR006.TXP	07945896828
				100	CCMR006.HXP	07945896864
6.25	6.25	CCMR6.25	CCMR 6-¼A	10	CCMR6.25TXP	07945896829
				100	CCMR6.25HXP	07945896865
7	007	CCMR007	CCMR 7A	10	CCMR007.TXP	07945896830
				100	CCMR007.HXP	07945896866
7.5	07.5	CCMR07.5	CCMR 7-½A	10	CCMR07.5TXP	07945896831
				100	CCMR07.5HXP	07945896867
8	008	CCMR008	CCMR 8A	10	CCMR008.TXP	07945896832
				100	CCMR008.HXP	07945896868
9	009	CCMR009	CCMR 9A	10	CCMR009.TXP	07945896833
				100	CCMR009.HXP	07945896869
10	010	CCMR010	CCMR 10A	10	CCMR010.TXP	07945896834
				100	CCMR010.HXP	07945896870

POWR-SPEED® Fuse

CLASS CC/CD CCMR SERIES FUSES

Ordering Information

AMPERE	AMPERE CODE	CATALOG NUMBER	PRODUCT MARKING	PACK QUANTITY	ORDERING NUMBER	UPC
12	012	CCMR012	CCMR 12A	10	CCMR012.TXP	07945896835
				100	CCMR012.HXP	07945896871
15	015	CCMR015	CCMR 15A	10	CCMR015.TXP	07945896836
				100	CCMR015.HXP	07945896872
17.5	17.5	CCMR17.5	CCMR 17-½A	10	CCMR17.5TXP	07945896837
				100	CCMR17.5HXP	07945896873
20	020	CCMR020	CCMR 20A	10	CCMR020.TXP	07945896838
				100	CCMR020.HXP	07945896874
25	025	CCMR025	CCMR 25A	10	CCMR025.TXP	07945896839
				100	CCMR025.HXP	07945896875
30	030	CCMR030	CCMR 30A	10	CCMR030.TXP	07945896840
				100	CCMR030.HXP	07945896876
35	035	CCMR035	CCMR 35	10	CCMR035.T	07945801706
40	040	CCMR040	CCMR 40	10	CCMR040.T	07945801707
45	045	CCMR045	CCMR 45	10	CCMR045.T	07945801708
50	050	CCMR050	CCMR 50	10	CCMR050.T	07945801709
60	060	CCMR060	CCMR 60	10	CCMR060.T	07945801710

Electrical Specifications

AMPERAGE RATING	VOLTAGE RATING		INTERRUPTING RATING		WATTS LOSS AT 100% RATED CURRENT (W)	WATTS LOSS AT 80% RATED CURRENT (W)	TOTAL CLEARING I²T (A² SEC) 200 kA	AGENCY APPROVALS		
	AC	DC	AC	DC				UL	CSA	RoHS
2-¼	600	300	200 kA	20 kA	1.55	0.99	351	•	•	•
2-½	600	300	200 kA	20 kA	1.99	1.26	192	•	•	•
3	600	300	200 kA	20 kA	1.55	1.02	286	•	•	•
4	600	300	200 kA	20 kA	1.62	1.04	1870	•	•	•
5	600	250	200 kA	20 kA	1.89	1.20	1060	•	•	•
6-¼	600	250	200 kA	20 kA	1.72	1.08	797	•	•	•
7-½	600	250	200 kA	20 kA	1.72	1.09	983	•	•	•
8	600	250	200 kA	20 kA	1.39	0.83	431	•	•	•
10	600	250	200 kA	20 kA	1.49	0.90	1250	•	•	•
15	600	500	200 kA	20 kA	1.77	1.03	1120	•	•	•
20	600	500	200 kA	20 kA	2.3	1.39	918	•	•	•
30	600	500	200 kA	20 kA	2.75	1.62	1790	•	•	•

Temperature Derating Curve (Temperature of Air Immediately Surrounding Fuse)

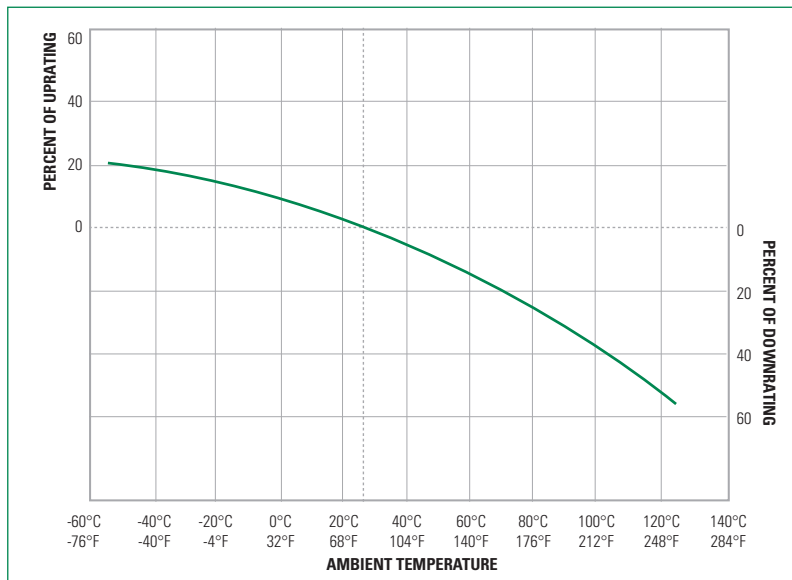

Current-Limiting Effects

SHORT CIRCUIT CURRENT*	APPARENT RMS SYMMETRICAL CURRENT FOR VARIOUS FUSE RATINGS																	
	2.25A	2.5A	3A	4A	5A	6.25A	7.5A	8A	10A	12A	15A	20A	30A	35A	40A	45A	50A	60A
5,000	203	224	287	289	460	472	442	437	359	369	435	355	621	1,170	1,240	1,320	1,070	1,525
10,000	256	282	361	364	580	595	557	551	452	465	548	447	783	1,480	1,565	1,670	1,355	1,930
15,000	293	323	413	416	664	681	637	631	517	532	627	512	896	1,695	1,795	1,915	1,555	2,200
20,000	323	356	455	458	730	750	702	694	569	585	690	563	987	1,870	1,980	2,110	1,710	2,430
25,000	348	383	490	493	787	808	756	748	613	630	743	607	1,063	2,015	2,135	2,275	1,845	2,620
30,000	370	407	521	524	836	858	803	795	651	670	790	645	1,129	2,145	2,270	2,420	1,965	2,780
35,000	389	429	548	552	880	903	845	837	686	705	832	679	1,189	2,260	2,390	2,550	2,070	2,885
40,000	407	448	573	577	920	944	884	875	717	737	870	709	1,243	2,360	2,500	2,665	2,165	3,025
50,000	438	483	617	622	991	1,017	952	942	772	794	937	764	1,339	2,545	2,695	2,875	2,330	3,200
60,000	466	513	656	661	1,053	1,081	1,012	1,001	821	844	995	812	1,423	2,705	2,865	3,055	2,480	3,350
80,000	513	564	722	727	1,159	1,190	1,114	1,102	903	929	1,096	894	1,566	2,985	3,160	3,365	2,730	3,540
100,000	552	608	778	783	1,249	1,282	1,200	1,187	973	1,001	1,180	963	1,687	3,215	3,405	3,630	2,945	3,685
150,000	632	696	890	897	1,430	1,467	1,373	1,359	1,114	1,146	1,351	1,102	1,931	3,685	3,905	4,160	3,375	4,030
200,000	696	766	980	987	1,574	1,615	1,511	1,496	1,226	1,261	1,487	1,213	2,125	4,060	4,300	4,580	3,720	4,230

*Prospective RMS Symmetrical Amperes Short-Circuit Current
 Note: Data Derived from Peak Let-Thru Curves

Peak Let-Thru Curves

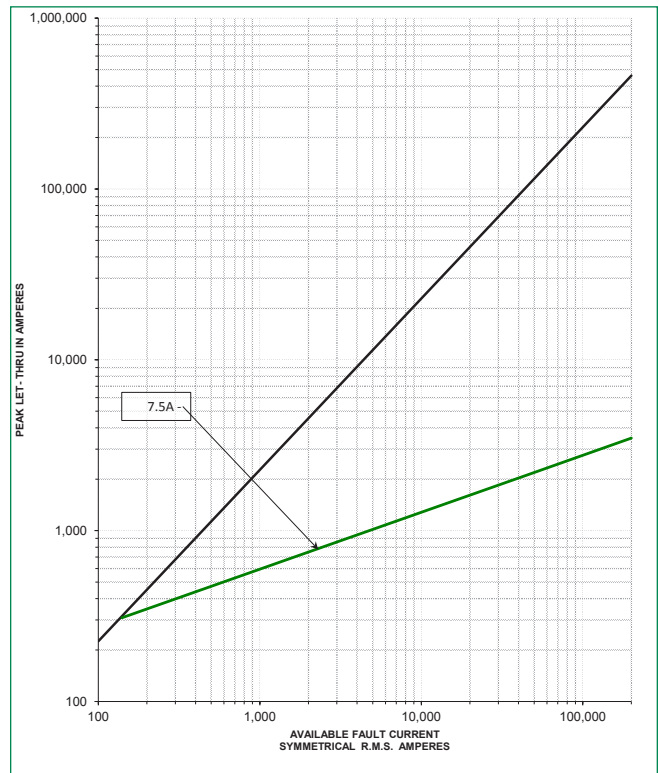
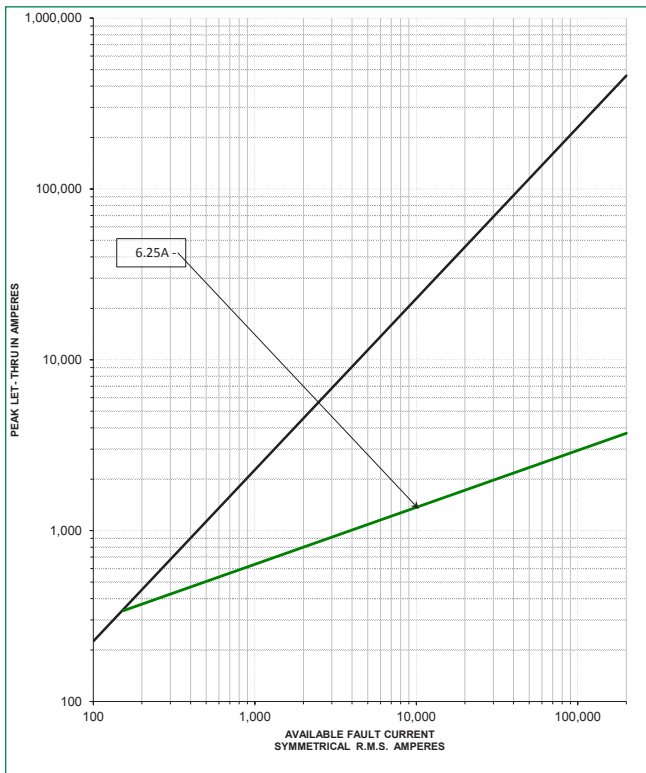
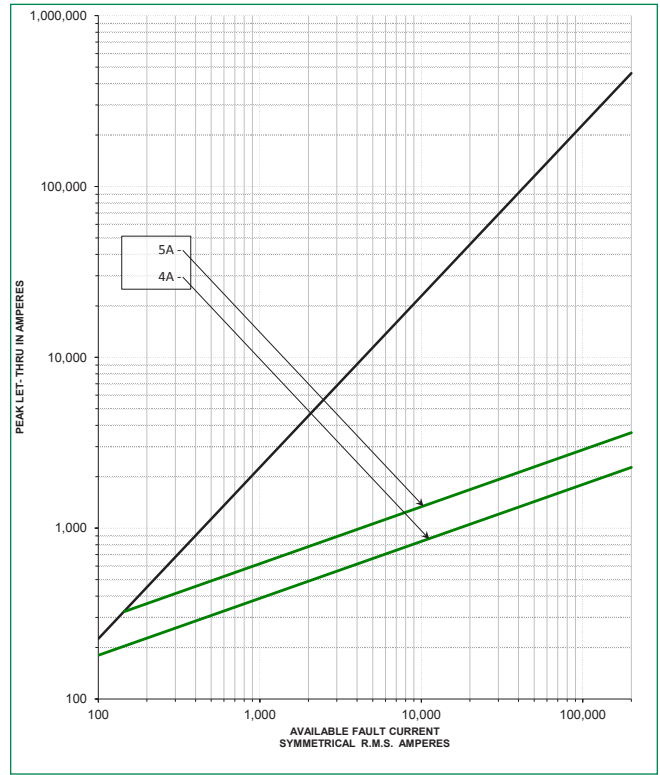
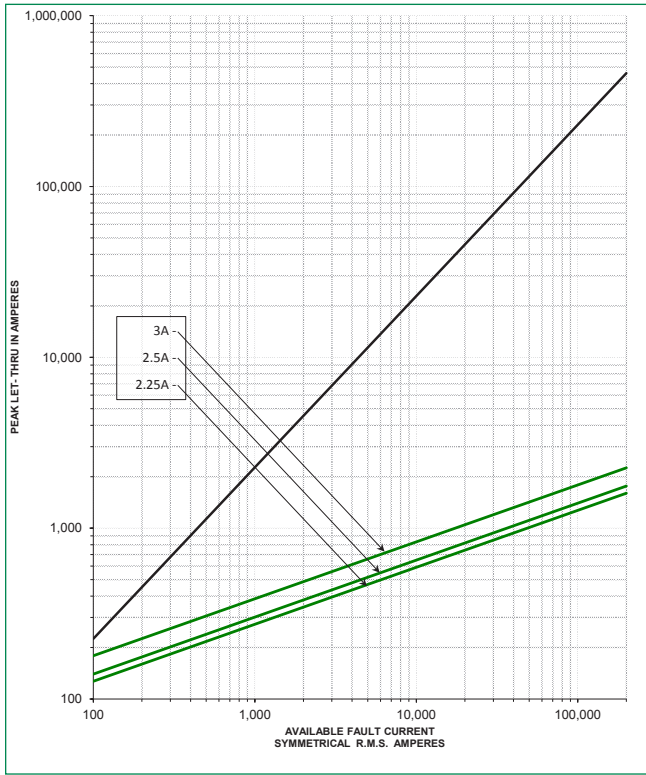

POWR-SPEED® Fuse

CLASS CC/CD CCMR SERIES FUSES

Microswitch [Dimensions in millimeters]

MS3H1000C

Document Number: OL-MS3H1000C Rev. B

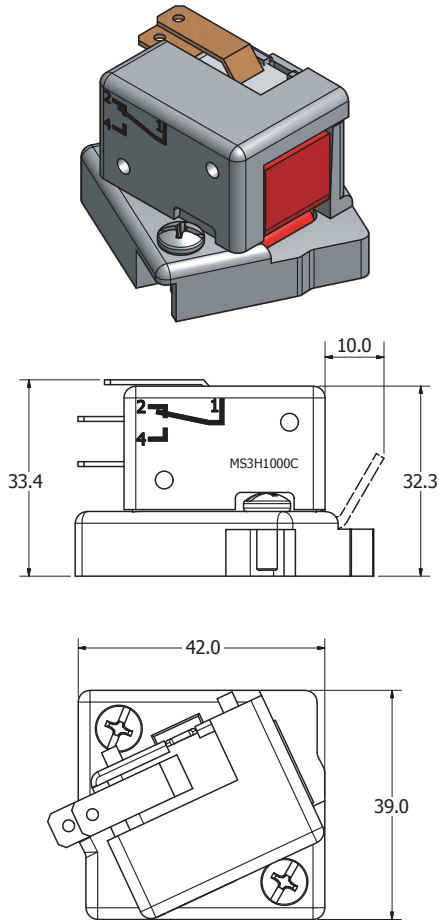

MS7H1500C

Document Number: OL-MS7H1500C Rev. B

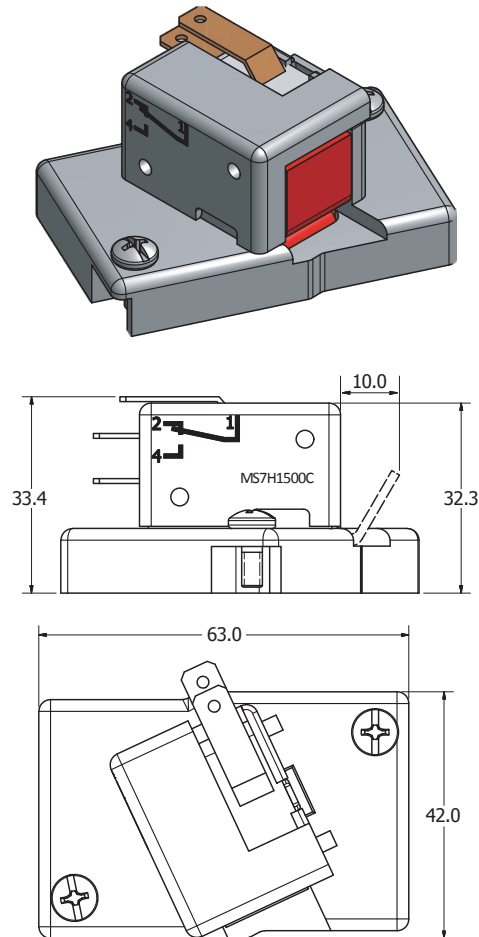

Electrical Characteristics

CATALOG NUMBER/ ORDERING NUMBER	INDICATING STYLE	INSULATION VOLTAGE RATING (VAC)	FUSE CASE SIZE	POSITIVE OPERATING MIN VOLTAGE / MIN CURRENT	INTERRUPTING RATING						OPERATING TEMP.	RELATIVE HUMIDITY	PACK QUANTITY	
					CURRENT	NON-INDUCTIVE LOAD			INDUCTIVE LOAD (DC L/R=25 ms)					
						30 V	110 V	250 V	30 V	110 V				250 V
MS3H1000C*	Standard NO-NC	1000	30, 31, 32, 33	4 V / 1mA	ac (50/60 Hz)	5 A	5 A	5 A	5 A	5 A	4 A	-60 °C to +125 °C	95 %	3 pcs/bag
					dc	5 A	0.6 A	0.3 A	3 A	0.2 A	0.1 A			
MS7H1500C*	Standard NO-NC	1500	70, 71, 72, 73		ac (50/60 Hz)	5 A	5 A	5 A	5 A	5 A	4 A	-60 °C to +125 °C	95 %	3 pcs/bag
					dc	5 A	0.6 A	0.3 A	3 A	0.2 A	0.1 A			

* Contains internal microswitch (Part Number: U83161.8), listed under UL File: E42016.

Disclaimer Notice – Information furnished is believed to be accurate and reliable. However, users should independently evaluate the suitability of and test each product selected for their own applications. Littelfuse products are not designed for, and may not be used in, all applications. Read complete Disclaimer Notice at www.littelfuse.com/product-disclaimer.

Peak Let-Thru Curves

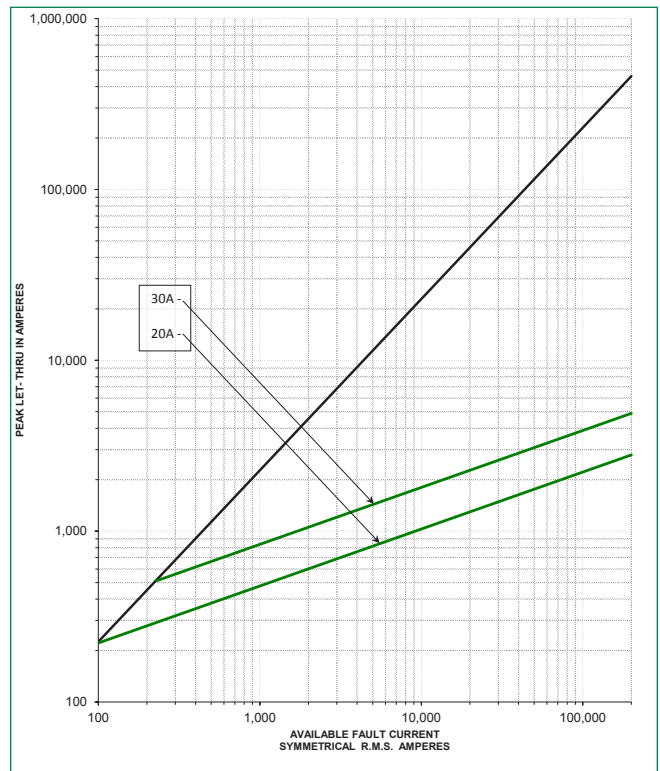
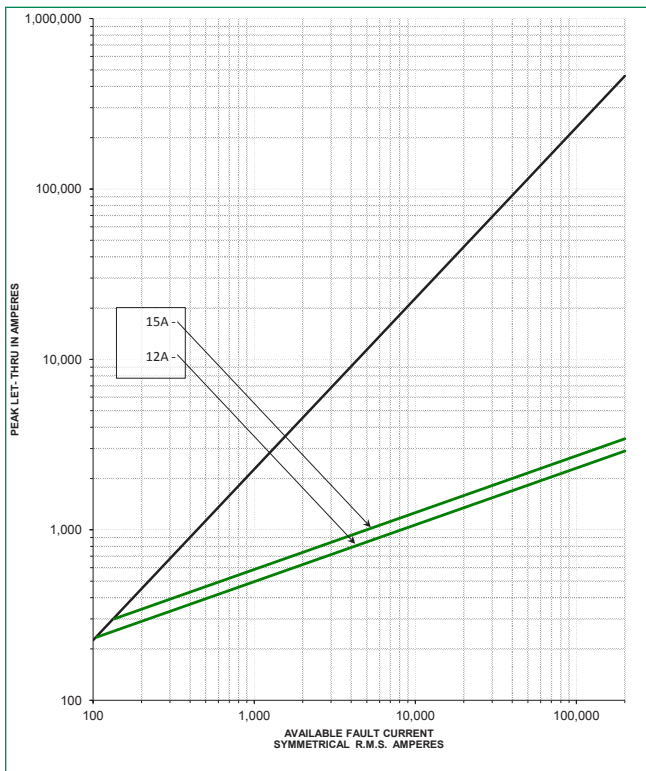
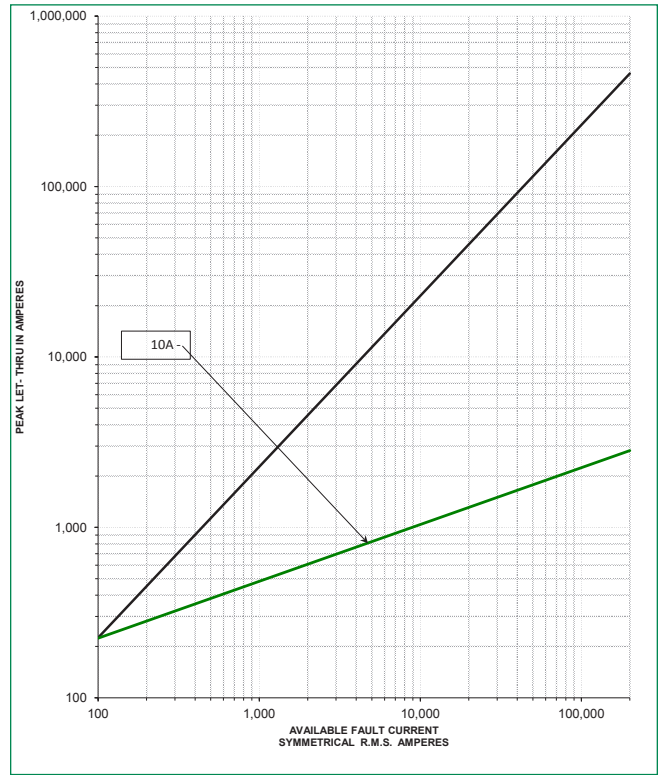
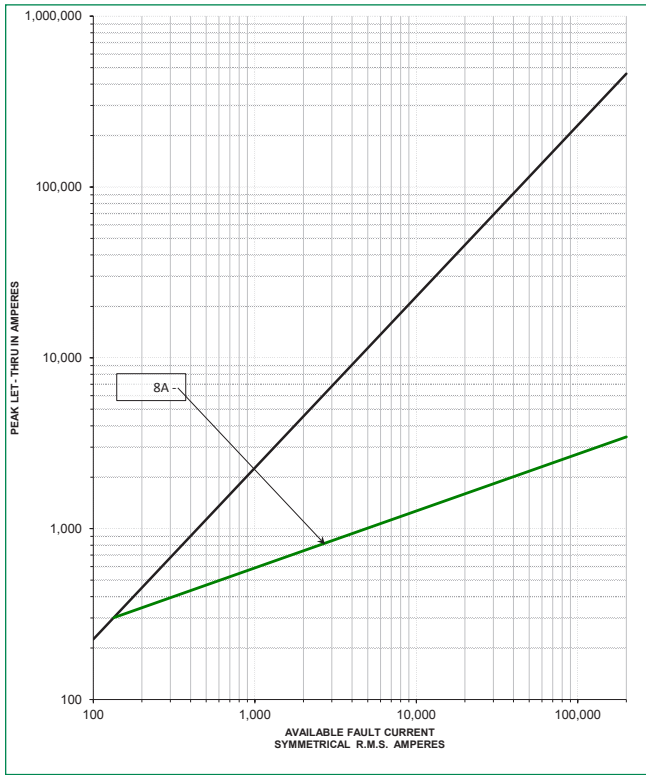

Peak Let-Thru Curves

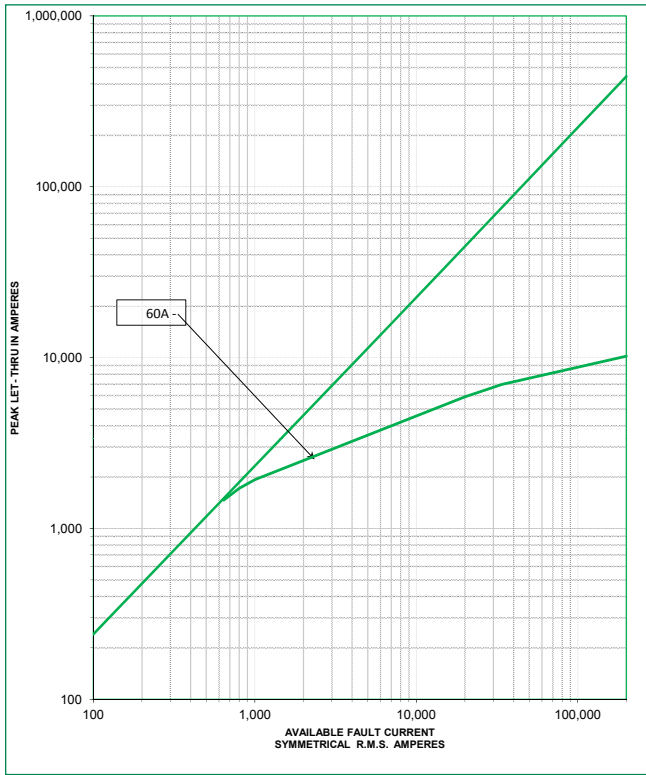

Time Current Curves

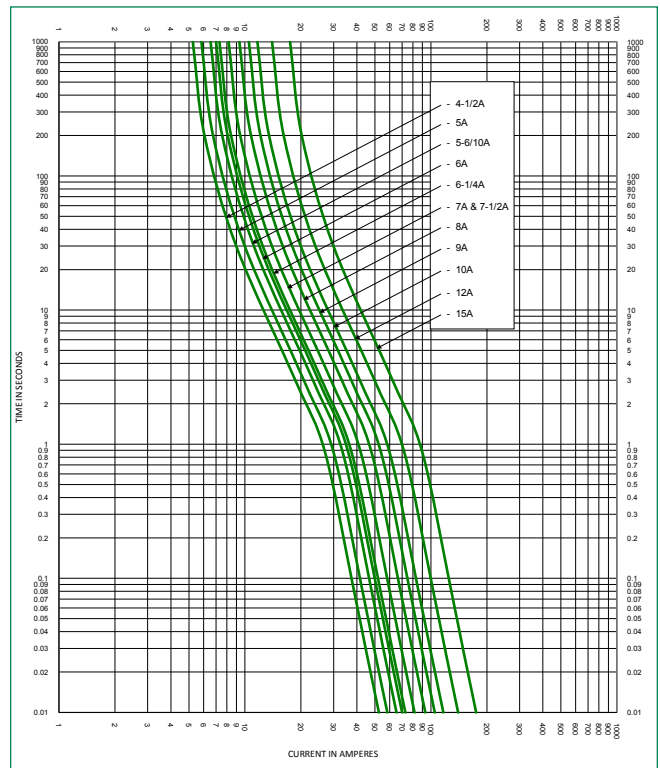
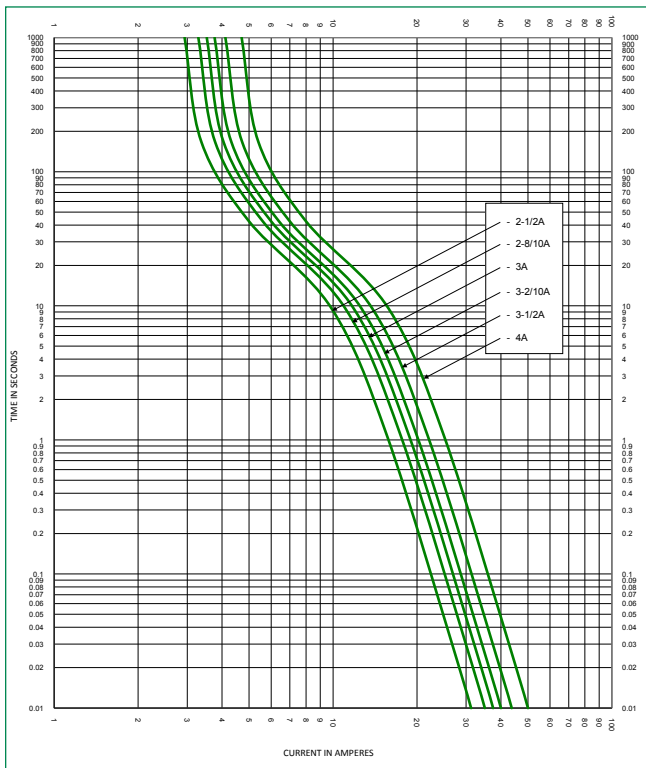
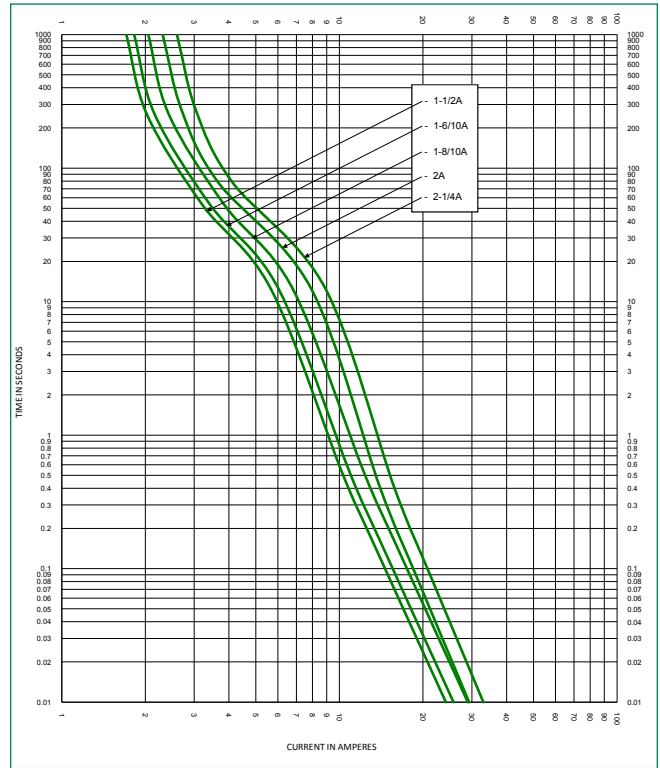
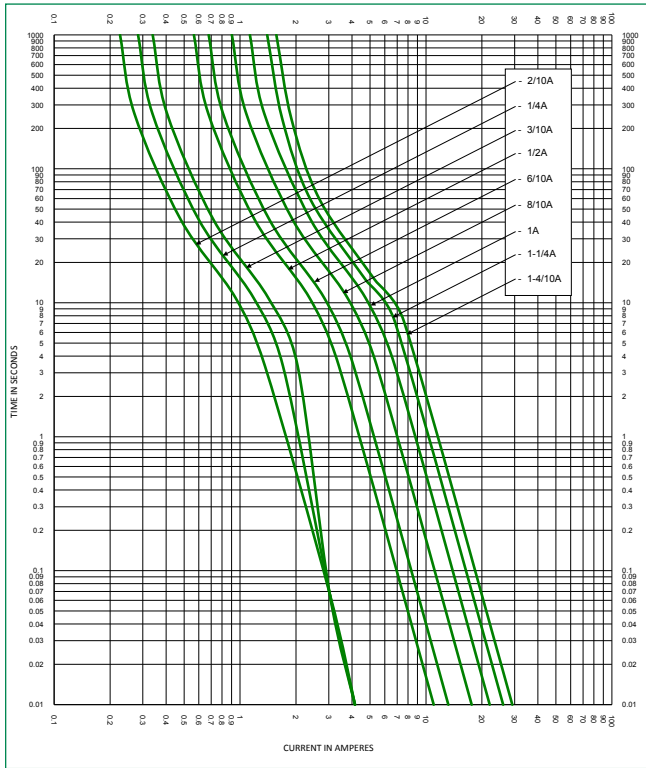

POWR-SPEED® Fuse

CLASS CC/CD CCMR SERIES FUSES

Time Current Curves

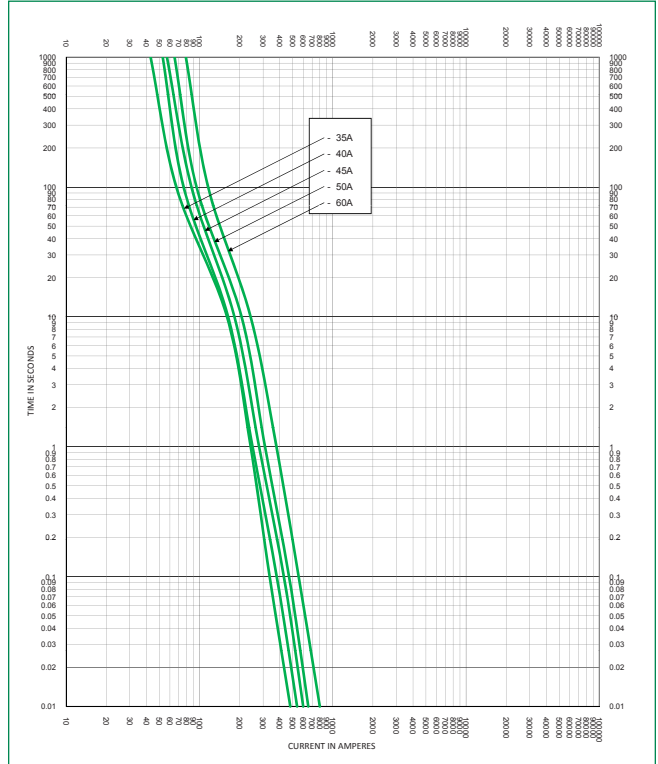
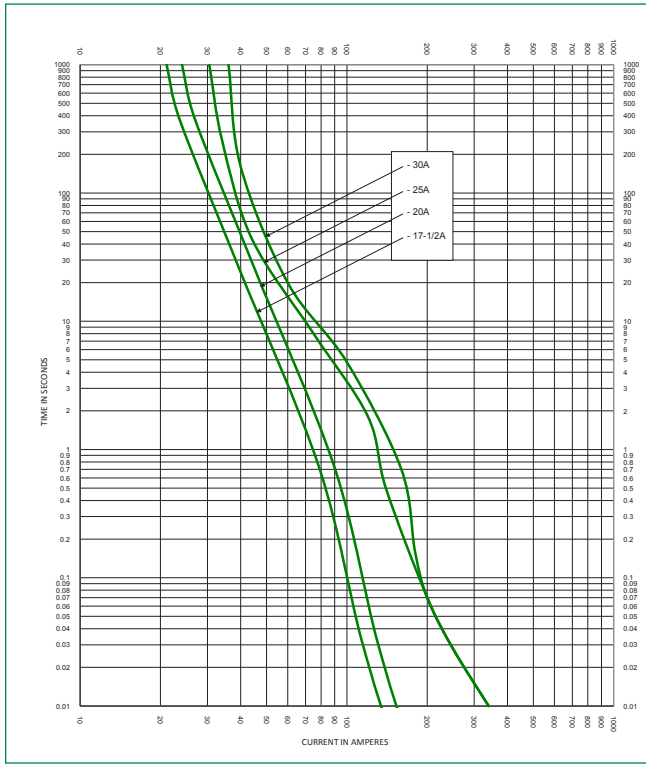

Disclaimer Notice – Information furnished is believed to be accurate and reliable. However, users should independently evaluate the suitability of and test each product selected for their own applications. Littelfuse products are not designed for, and may not be used in, all applications. Read complete Disclaimer Notice at www.littelfuse.com/product-disclaimer.

X-ON Electronics

Largest Supplier of Electrical and Electronic Components

Click to view similar products for [Littelfuse](#) manufacturer:

Other Similar products are found below :

[V130LA10A](#) [1SMB33AT3G](#) [1SMA24AT3G](#) [0362030.V](#) [59022-3-S-02-F](#) [46213150000](#) [59022-3-T-02-F](#) [59022-3-U-02-F](#) [MDRR-DT-30-35-F](#) [FLEX-14-35-40](#) [SK225RDTP](#) [GTCA28-231M-R05](#) [SMBJ5.0](#) [00970019XP](#) [LX5090](#) [0217010.HXP](#) [0217.500HXP](#) [02181.25TXP](#) [0218.500TXP](#) [0224006.HXUP](#) [740GN](#) [815.650](#) [FLA2.25](#) [FLSR400](#) [FLSR600](#) [900-1535-012RN](#) [901-134](#) [970699013](#) [971-670A-92WCN](#) [153.5631.5601](#) [155100](#) [157.5701.6101](#) [1.5KE110A-B](#) [1.5KE220A](#) [1.5SMC150CA](#) [BLF006](#) [BLF008](#) [JLLS-250](#) [235.200](#) [901-152C-042RN](#) [920-401X-330BN](#) [282007](#) [LFC600602CID](#) [LFR600303CID](#) [LJCA030.X](#) [SE-GRM024](#) [SE-TA6ASF-WL](#) [2N6509G](#) [980-788A-070](#)
[FLNR100](#)