

### DSTF20150CR

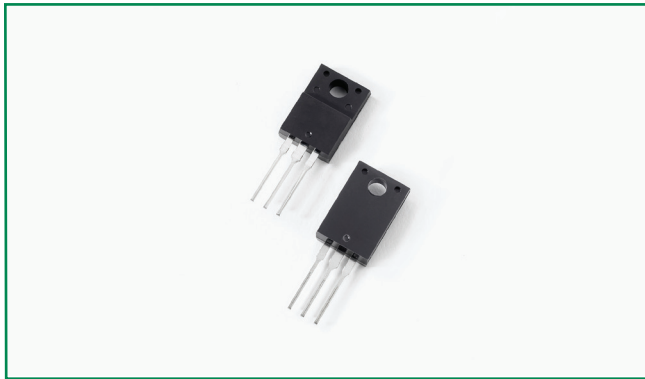

#### Pin out

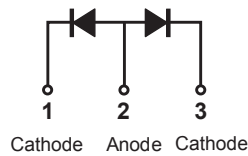

#### Description

Littelfuse DST series Ultra Low  $V_F$  Schottky Barrier Rectifier is designed to meet the general requirements of commercial and industry applications by providing high temperature, low leakage and lower  $V_F$  products.

It is suitable for high frequency switching mode power supply, free-wheeling diodes and polarity protection diodes.

#### Features

- Ultra low forward voltage drop
- High frequency operation
- High junction temperature capability
- Guard ring for enhanced ruggedness and long term reliability
- Common cathode configuration in ITO-220AB package

#### Applications

- Switching mode power supply
- DC/DC converters
- Free-Wheeling diodes
- Polarity Protection Diodes

#### Maximum Ratings

Parameters	Symbol	Test Conditions	Max	Unit
Peak Inverse Voltage	$V_{RWM}$	-	150	V
Average Forward Current	$I_{F(AV)}$	50% duty cycle @ $T_c = 80^\circ\text{C}$ rectangular wave form	10 (per leg)	A
			20 (total device)	
Peak One Cycle Non-Repetitive Surge Current (per leg)	$I_{FSM}$	8.3 ms, half Sine pulse	150	A

#### Electrical Characteristics

Parameters	Symbol	Test Conditions	Typ	Max	Unit
Forward Voltage Drop (per leg) *	$V_{F1}$	@5A, Pulse, $T_J = 25^\circ\text{C}$	0.70	-	V
		@10A, Pulse, $T_J = 25^\circ\text{C}$	1.02	1.20	
	$V_{F2}$	@5A, Pulse, $T_J = 125^\circ\text{C}$	0.61	-	
		@10A, Pulse, $T_J = 125^\circ\text{C}$	0.76	0.80	
Reverse Current (per leg) *	$I_{R1}$	@ $V_R = \text{rated } V_R$ , $T_J = 25^\circ\text{C}$	-	0.15	mA
	$I_{R2}$	@ $V_R = \text{rated } V_R$ , $T_J = 125^\circ\text{C}$	4	15	mA

\* Pulse Width < 300 $\mu\text{s}$ , Duty Cycle < 2%

**Thermal-Mechanical Specifications**

Parameters	Symbol	Test Conditions	Max	Unit
Junction Temperature	$T_J$		-55 to +150	°C
Storage Temperature	$T_{stg}$		-55 to +150	°C
Thermal Resistance Junction to Case (per leg)	$R_{thJC}$	DC operation	5.0	°C/W
Approximate Weight	wt		2	g
Case Style		ITO-220AB		

**Figure 1: Typical Forward Characteristics**

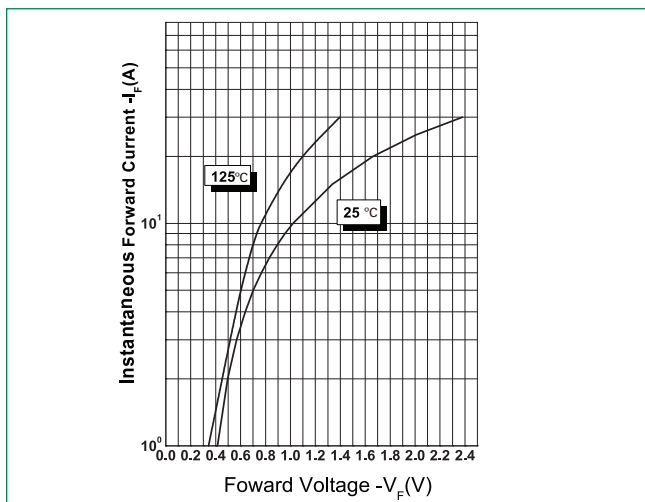

**Figure 2: Typical Reverse Characteristics**

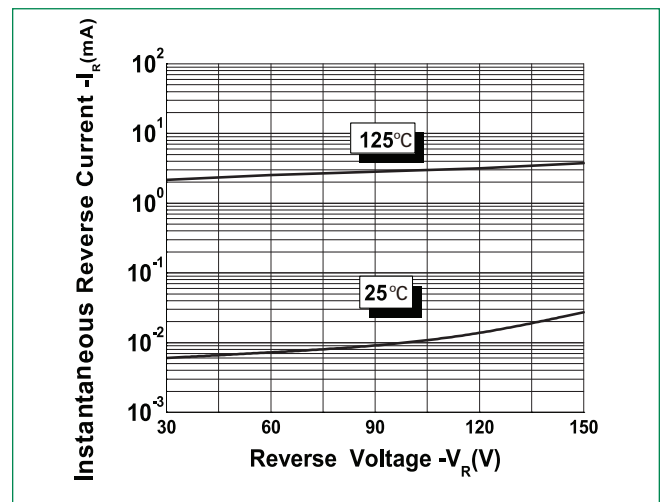

**Figure 3: Typical Junction Capacitance**

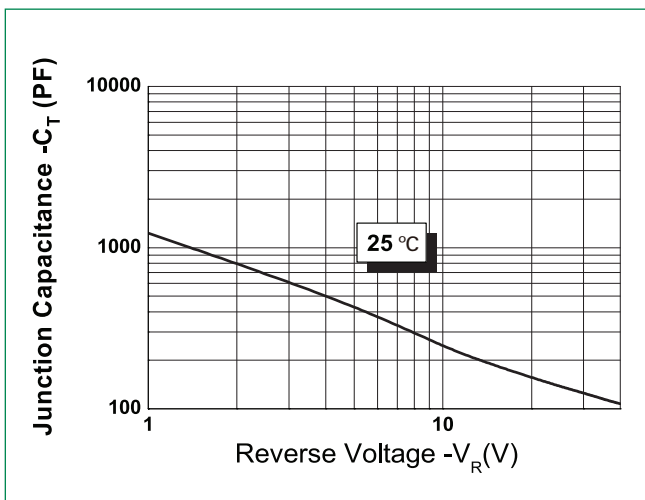

**Dimensions- ITO-220AB**



Symbol	Millimeters		
	Min	Typ	Max
A	4.30	4.50	4.70
A1	1.10	1.30	1.50
A2	2.80	3.00	3.20
A3	2.50	2.70	2.90
b	0.50	0.60	0.75
b1	1.10	1.20	1.35
b2	1.50	1.60	1.75
b3	1.20	1.30	1.45
b4	1.60	1.70	1.85
c	0.55	0.60	0.75
D	14.80	15.00	15.20
E	9.96	10.16	10.36
e		2.55	
e1		5.10	
H1	6.50	6.70	6.90
L	12.70	13.20	13.70
L1	1.60	1.80	2.00
L2	0.80	1.00	1.20
L3	0.60	0.80	1.00
ØP1	3.30	3.50	3.70
ØP2	2.99	3.19	3.39
Q	2.50	2.70	2.90
θ1		5°	
θ2		4°	
θ3		10°	
θ4		5°	
θ5		5°	

**Packing Options**

Part Number	Marking	Packing Mode	M.O.Q
DSTF20150CR	DSTF20150CR	50pcs / Tube	1000

**Tube Specification**

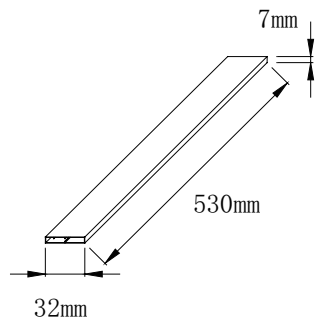

**Part Numbering and Marking System**

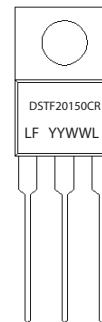

- DST = Device Type
- F = Package type
- 20 = Forward Current (20A)
- 150 = Reverse Voltage (150V)
- CR = Configuration
- LF = Littelfuse
- YY = Year
- WW = Week
- L = Lot Number

## X-ON Electronics

Largest Supplier of Electrical and Electronic Components

*Click to view similar products for [Schottky Diodes & Rectifiers](#) category:*

*Click to view products by [Littelfuse](#) manufacturer:*

Other Similar products are found below :

[MA4E2039](#) [D1FH3-5063](#) [MBR0530L-TP](#) [MBR10100CT-BP](#) [MBR1545CT](#) [MMBD301M3T5G](#) [RB160M-50TR](#) [RB551V-30](#)  
[BAS16E6433HTMA1](#) [BAT 54-02LRH E6327](#) [NSR05F40QNXT5G](#) [NTE555](#) [JANS1N6640](#) [SB07-03C-TB-H](#) [SB1003M3-TL-W](#) [SK310-T](#)  
[SK32A-LTP](#) [SK34B-TP](#) [SS3003CH-TL-E](#) [GA01SHT18](#) [CRS10I30A\(TE85L,QM](#) [MA4E2501L-1290](#) [MBRB30H30CT-1G](#) [SB007-03C-TB-](#)  
[E](#) [SK32A-TP](#) [SK33B-TP](#) [SK38B-TP](#) [NRVBM120LT1G](#) [NTE505](#) [NTSB30U100CT-1G](#) [SS15E-TP](#) [VS-6CWQ10FNHM3](#) [ACDBA1100LR-](#)  
[HF](#) [ACDBA1200-HF](#) [ACDBA140-HF](#) [ACDBA2100-HF](#) [ACDBA3100-HF](#) [CDBQC0530L-HF](#) [CDBQC0240LR-HF](#) [ACDBA260LR-HF](#)  
[ACDBA1100-HF](#) [SK310B-TP](#) [MA4E2502L-1246](#) [MA4E2502H-1246](#) [NRVBM120ET1G](#) [NSR01L30MXT5G](#) [NTE573](#) [NTE6081](#) [SB560](#)  
[PMAD1108-LF](#)