

Lx01Ex & LxNx & Qx01Ex & QxNx Series

RoHS

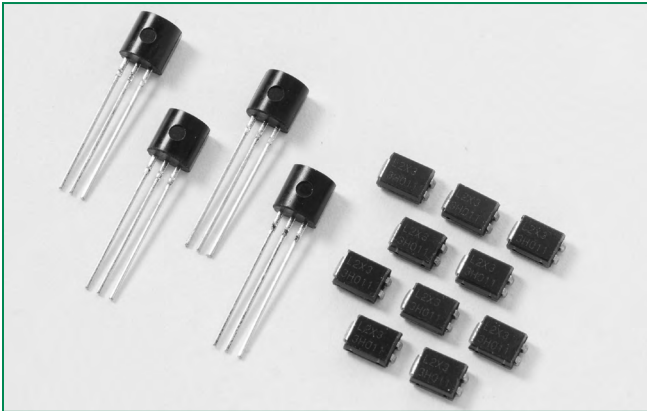

Description

1 Amp bi-directional solid state switch series is designed for AC switching and phase control applications such as motor speed and temperature modulation controls, lighting controls, and static switching relays.

Sensitive type devices guarantee gate control in Quadrants I & IV needed for digital control circuitry.

Standard type devices normally operate in Quadrants I & III triggered from AC line.

Features & Benefits

- RoHS Compliant
- Glass – passivated junctions
- Voltage capability up to 600 V
- Surge capability up to 20 A

Applications

Excellent for lower current heating controls, water valves, and solenoids.

Typical applications are AC solid-state switches, home/ brown goods and white goods appliances.

Sensitive gate Triacs can be directly driven by microprocessor or popular opto-couplers/isolators.

Main Features

| Symbol | Value | Unit |
|-------------------|------------|------|
| $I_{T(RMS)}$ | 1 | A |
| V_{DRM}/V_{RRM} | 400 to 600 | V |
| $I_{GT(Q1)}$ | 3 to 25 | mA |

Schematic Symbol

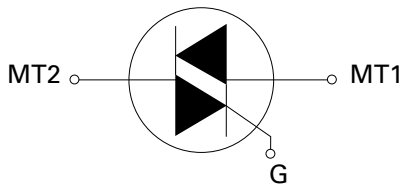

Additional Information



Datasheet



Resources



Samples

Absolute Maximum Ratings – Sensitive Triacs (4 Quadrants)

| Symbol | Parameter | Value | Unit |
|--------------|---|---|------------------------------|
| $I_{T(RMS)}$ | RMS on-state current (full sine wave) | Lx01Ey/LxNy $T_c = 50^\circ\text{C}$ | 1 A |
| I_{TSM} | Non repetitive surge peak on-state current (full cycle, T_j initial = 25°C) | $f = 50\text{ Hz}$ $t = 20\text{ ms}$ | 16.7 |
| | | $f = 60\text{ Hz}$ $t = 16.7\text{ ms}$ | 20 |
| I^2t | I^2t Value for fusing | $t_p = 8.3\text{ ms}$ | 1.6 A^2s |
| di/dt | Critical rate of rise of on-state current ($I_G = 50\text{mA}$ with $\leq 0.1\mu\text{s}$ rise time) | $f = 120\text{ Hz}$ $T_j = 110^\circ\text{C}$ | 20 $\text{A}/\mu\text{s}$ |
| I_{GTM} | Peak gate trigger current | $t_p \leq 10\ \mu\text{s}$ $T_j = 110^\circ\text{C}$ | 1 A |
| $P_{G(AV)}$ | Average gate power dissipation | $T_j = 110^\circ\text{C}$ | 0.2 W |
| T_{stg} | Storage temperature range | Lx01Ey | -65 to 150 |
| | | LxNy | -40 to 125 |
| T_j | Operating junction temperature range | Lx01Ey | -65 to 110 |
| | | LxNy | -40 to 110 |

Note: x = voltage, y = sensitivity

Absolute Maximum Ratings — Standard Triacs

| Symbol | Parameter | | | Value | Unit |
|--------------|--|---|---------------------------|------------|------------------|
| $I_{T(RMS)}$ | RMS on-state current (full sine wave) | Qx01Ey/QxNy | $T_C = 60^\circ\text{C}$ | 1 | A |
| I_{TSM} | Non repetitive surge peak on-state current (full cycle, T_J initial = 25°C) | f = 50 Hz | t = 20 ms | 16.7 | A |
| | | f = 60 Hz | t = 16.7 ms | 20 | |
| I^2t | I^2t Value for fusing | $t_p = 8.3$ ms | | 1.6 | A ² s |
| di/dt | Critical rate of rise of on-state current ($I_G = 200\text{mA}$ with $\leq 0.1\mu\text{s}$ rise time) | f = 120 Hz | $T_J = 125^\circ\text{C}$ | 20 | A/ μs |
| I_{GTM} | Peak gate trigger current | $t_p \leq 10 \mu\text{s};$ $I_{GT} \leq I_{GTM}$ | $T_J = 125^\circ\text{C}$ | 1 | A |
| $P_{G(AV)}$ | Average gate power dissipation | $T_J = 125^\circ\text{C}$ | | 0.2 | W |
| T_{stg} | Storage temperature range | Qx01Ey | | -65 to 150 | $^\circ\text{C}$ |
| | | QxNy | | -40 to 150 | |
| T_J | Operating junction temperature range | Qx01Ey | | -65 to 125 | $^\circ\text{C}$ |
| | | QxNy | | -40 to 125 | |

Note: x = voltage, y = sensitivity

Electrical Characteristics ($T_J = 25^\circ\text{C}$, unless otherwise specified) — Sensitive Triac (4 Quadrants)

| Symbol | Test Conditions | Quadrant | | Lx01E3 LxN3 | Lx01E5 LxN5 | Lx01E6 LxN6 | Lx01E8 LxN8 | Unit |
|----------|---|--------------|------|----------------|----------------|----------------|----------------|------------------|
| | | I – II – III | IV | | | | | |
| I_{GT} | $V_D = 12\text{V}$ $R_L = 60 \Omega$ | I – II – III | MAX. | 3 | 5 | 5 | 10 | mA |
| | | IV | | 3 | 5 | 10 | 20 | |
| V_{GT} | $V_D = 12\text{V}$ $R_L = 60 \Omega$ | ALL | MAX. | 1.3 | | | | V |
| V_{GD} | $V_D = V_{DRM}$ $R_L = 3.3 \text{ k}\Omega$ $T_J = 110^\circ\text{C}$ | ALL | MIN. | 0.2 | | | | V |
| I_H | $I_T = 100\text{mA}$ | | MAX. | 5 | 10 | 10 | 15 | mA |
| dv/dt | $V_D = V_{DRM}$ Gate Open $T_J = 100^\circ\text{C}$ | 400V | TYP. | 20 | 20 | 30 | 35 | V/ μs |
| | | 600V | | 10 | 10 | 20 | 25 | |
| (dv/dt)c | (di/dt)c = 0.54 A/ms $T_J = 110^\circ\text{C}$ | | TYP. | 0.5 | 1 | 1 | 1 | V/ μs |
| t_{gt} | $I_G = 2 \times I_{GT}$ PW = 15 μs $I_T = 1.41$ A(pk) | | TYP. | 2.8 | 3.0 | 3.0 | 3.2 | μs |

Electrical Characteristics ($T_J = 25^\circ\text{C}$, unless otherwise specified) — Standard Triac

| Symbol | Test Conditions | Quadrant | | Qx01E3 QxN3 | Qx01E4 QxN4 | Unit |
|----------|---|--------------|------|----------------|----------------|------------------|
| | | I – II – III | IV | | | |
| I_{GT} | $V_D = 12\text{V}$ $R_L = 60 \Omega$ | I – II – III | MAX. | 10 | 25 | mA |
| | | IV | TYP. | 25 | 50 | |
| V_{GT} | $V_D = 12\text{V}$ $R_L = 60 \Omega$ | I – II – III | MAX. | 1.3 | 1.3 | V |
| V_{GD} | $V_D = V_{DRM}$ $R_L = 3.3 \text{ k}\Omega$ $T_J = 125^\circ\text{C}$ | ALL | MIN. | 0.2 | 0.2 | V |
| I_H | $I_T = 200\text{mA}$ | | MAX. | 15 | 25 | mA |
| dv/dt | $V_D = V_{DRM}$ Gate Open $T_J = 125^\circ\text{C}$ | 400V | MIN. | 30 | 40 | V/ μs |
| | | 600V | | 20 | 30 | |
| (dv/dt)c | (di/dt)c = 0.54 A/ms $T_J = 125^\circ\text{C}$ | | TYP. | 1 | 1 | V/ μs |
| t_{gt} | $I_G = 2 \times I_{GT}$ PW = 15 μs $I_T = 1.41$ A(pk) | | TYP. | 2.5 | 3.0 | μs |

Note: x = voltage, y = sensitivity

Static Characteristics ($T_J = 25^\circ\text{C}$, unless otherwise specified)

| Symbol | Test Conditions | Value | Unit | |
|------------------------|--|-------|------------------------------------|-----------------------------------|
| V_{TM} | $I_{TM} = 1.41\text{A}$ $t_p = 380\ \mu\text{s}$ | MAX. | 1.60 V | |
| I_{DRM} I_{RRM} | $V_{DRM} = V_{RRM}$ | MAX. | Lx01Ey / LxNy | |
| | | | $T_J = 25^\circ\text{C}$ 400-600V | 2 μA |
| | | | $T_J = 110^\circ\text{C}$ 400-600V | 0.1 mA |
| | | | Qx01Ey / QxNy | $T_J = 25^\circ\text{C}$ 400-600V |
| | | | $T_J = 125^\circ\text{C}$ 400-600V | 1 mA |

Thermal Resistances

| Symbol | Parameter | Value | Unit |
|-------------------|-----------------------|----------|------|
| $R_{\theta(J-C)}$ | Junction to case (AC) | L/Qx01Ey | 50 |
| | | L/QxNy | 40* |
| $R_{\theta(J-A)}$ | Junction to ambient | L/Qx01Ey | 95 |

Note: * = Mounted on 1 cm² copper (two-ounce) foil surface

Figure 1: Definition of Quadrants

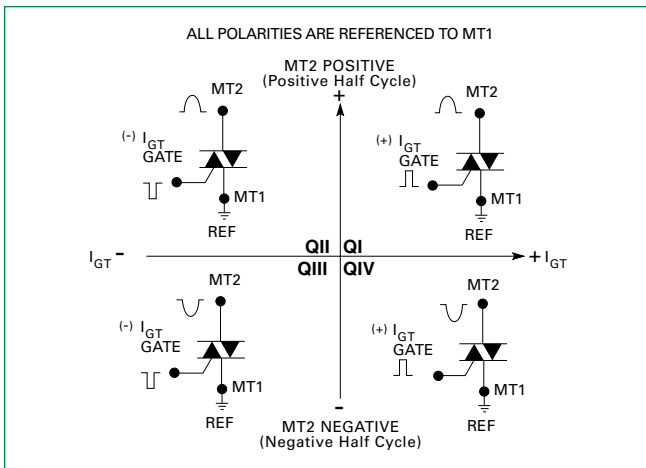

Figure 2: Normalized DC Gate Trigger Current for All Quadrants vs. Junction Temperature

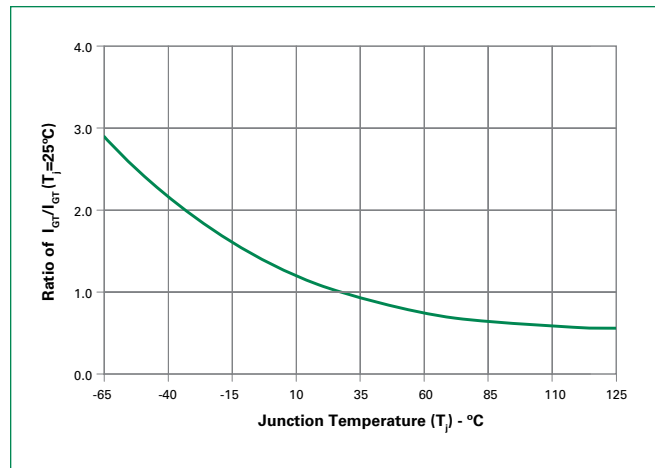

Figure 3: Normalized DC Holding Current vs. Junction Temperature



Figure 4: Normalized DC Gate Trigger Voltage for All Quadrants vs. Junction Temperature



Figure 5: Power Dissipation (Typical) vs. RMS On-State Current



Figure 6: Maximum Allowable Case Temperature vs. On-State Current



Figure 7: Maximum Allowable Ambient Temperature vs. On-State Current



Figure 8: On-State Current vs. On-State Voltage (Typical)



Figure 9: Surge Peak On-State Current vs. Number of Cycles



Soldering Parameters

| | | |
|--|------------------------------------|-------------------------|
| Reflow Condition | | Pb – Free assembly |
| Pre Heat | - Temperature Min ($T_{s(min)}$) | 150°C |
| | - Temperature Max ($T_{s(max)}$) | 200°C |
| | - Time (min to max) (t_s) | 60 – 180 secs |
| Average ramp up rate (Liquidus Temp) (T_L) to peak | | 5°C/second max |
| $T_{s(max)}$ to T_L - Ramp-up Rate | | 5°C/second max |
| Reflow | - Temperature (T_L) (Liquidus) | 217°C |
| | - Temperature (t_L) | 60 – 150 seconds |
| Peak Temperature (T_p) | | 260 ^{+0/-5} °C |
| Time within 5°C of actual peak Temperature (t_p) | | 20 – 40 seconds |
| Ramp-down Rate | | 5°C/second max |
| Time 25°C to peak Temperature (T_p) | | 8 minutes Max. |
| Do not exceed | | 280°C |



Physical Specifications

| | |
|--------------------------|---|
| Terminal Finish | 100% Matte Tin-plated |
| Body Material | UL recognized epoxy meeting flammability classification 94V-0 |
| Terminal Material | Copper Alloy |

Design Considerations

Careful selection of the correct device for the application's operating parameters and environment will go a long way toward extending the operating life of the Thyristor. Good design practice should limit the maximum continuous current through the main terminals to 75% of the device rating. Other ways to ensure long life for a power discrete semiconductor are proper heat sinking and selection of voltage ratings for worst case conditions. Overheating, overvoltage (including dv/dt), and surge currents are the main killers of semiconductors. Correct mounting, soldering, and forming of the leads also help protect against component damage.

Environmental Specifications

| Test | Specifications and Conditions |
|----------------------------------|--|
| AC Blocking | MIL-STD-750, M-1040, Cond A Applied Peak AC voltage @ 125°C for 1008 hours |
| Temperature Cycling | MIL-STD-750, M-1051, 100 cycles; -40°C to +150°C; 15-min dwell time |
| Temperature/Humidity | EIA / JEDEC, JESD22-A101 1008 hours; 320V - DC: 85°C; 85% rel humidity |
| High Temp Storage | MIL-STD-750, M-1031, 1008 hours; 150°C |
| Low-Temp Storage | 1008 hours; -40°C |
| Resistance to Solder Heat | MIL-STD-750 Method 2031 |
| Solderability | ANSI/J-STD-002, category 3, Test A |
| Lead Bend | MIL-STD-750, M-2036 Cond E |

Dimensions - Compak (C Package)



| Dimension | Inches | | Millimeters | |
|-----------|--------|-------|-------------|------|
| | Min | Max | Min | Max |
| A | 0.130 | 0.156 | 3.30 | 3.95 |
| B | 0.201 | 0.220 | 5.10 | 5.60 |
| C | 0.077 | 0.087 | 1.95 | 2.20 |
| D | 0.159 | 0.181 | 4.05 | 4.60 |
| E | 0.030 | 0.063 | 0.75 | 1.60 |
| F | 0.075 | 0.096 | 1.90 | 2.45 |
| G | 0.002 | 0.008 | 0.05 | 0.20 |
| H | 0.077 | 0.104 | 1.95 | 2.65 |
| J | 0.043 | 0.053 | 1.09 | 1.35 |
| K | 0.006 | 0.016 | 0.15 | 0.41 |
| L | 0.030 | 0.055 | 0.76 | 1.40 |
| M | 0.022 | 0.028 | 0.56 | 0.71 |
| N | 0.027 | 0.033 | 0.69 | 0.84 |
| P | 0.052 | 0.058 | 1.32 | 1.47 |

Dimensions - TO-92 (E Package)

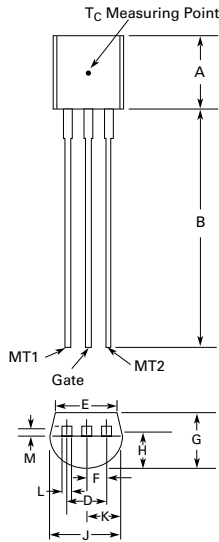

| Dimension | Inches | | Millimeters | |
|-----------|--------|-------|-------------|------|
| | Min | Max | Min | Max |
| A | 0.176 | 0.196 | 4.47 | 4.98 |
| B | 0.500 | - | 12.70 | - |
| D | 0.095 | 0.105 | 2.41 | 2.67 |
| E | 0.150 | - | 3.81 | - |
| F | 0.046 | 0.054 | 1.16 | 1.37 |
| G | 0.135 | 0.145 | 3.43 | 3.68 |
| H | 0.088 | 0.096 | 2.23 | 2.44 |
| J | 0.176 | 0.186 | 4.47 | 4.73 |
| K | 0.088 | 0.096 | 2.23 | 2.44 |
| L | 0.013 | 0.019 | 0.33 | 0.48 |
| M | 0.013 | 0.017 | 0.33 | 0.43 |

All leads insulated from case. Case is electrically nonconductive.

Product Selector

| Part Number | Voltage | | Gate Sensitivity Quadrants | | Type | Package |
|-------------|---------|------|----------------------------|-------|-----------------|---------|
| | 400V | 600V | I – II – III | IV | | |
| Lx01E3 | X | X | 3 mA | 3 mA | Sensitive Triac | TO-92 |
| LxN3 | X | X | 3 mA | 3 mA | Sensitive Triac | Compak |
| Lx01E5 | X | X | 5 mA | 5 mA | Sensitive Triac | TO-92 |
| LxN5 | X | X | 5 mA | 5 mA | Sensitive Triac | Compak |
| Lx01E6 | X | X | 5 mA | 10 mA | Sensitive Triac | TO-92 |
| Lx01E8 | X | X | 10 mA | 20 mA | Sensitive Triac | TO-92 |
| Qx01E3 | X | X | 10 mA | | Standard Triac | TO-92 |
| QxN3 | X | X | 10 mA | | Standard Triac | Compak |
| Qx01E4 | X | X | 25 mA | | Standard Triac | TO-92 |
| QxN4 | X | X | 25 mA | | Standard Triac | Compak |

Note: x- voltage

Packing Options

| Part Number | Marking | Weight | Packing Mode | Base Quantity |
|-------------|----------|---------|------------------|---------------|
| L/Qx01Ey | L/Qx01Ey | 0.188 g | Bulk | 2000 |
| L/Qx01EyRP | L/Qx01Ey | 0.188 g | Reel Pack | 2000 |
| L/Qx01EyAP | L/Qx01Ey | 0.188 g | Ammo Pack | 2000 |
| L/QxNyRP | L/QxNy | 0.081 g | Embossed Carrier | 2500 |

Note: x = Voltage; y = Sensitivity

TO-92 (3-lead) Reel Pack (RP) Radial Ledged

Meets all EIA-468-C Standards



TO-92 (3-lead) Ammo Pack (AP) Radial Ledged

Meets all EIA-468-C Standards

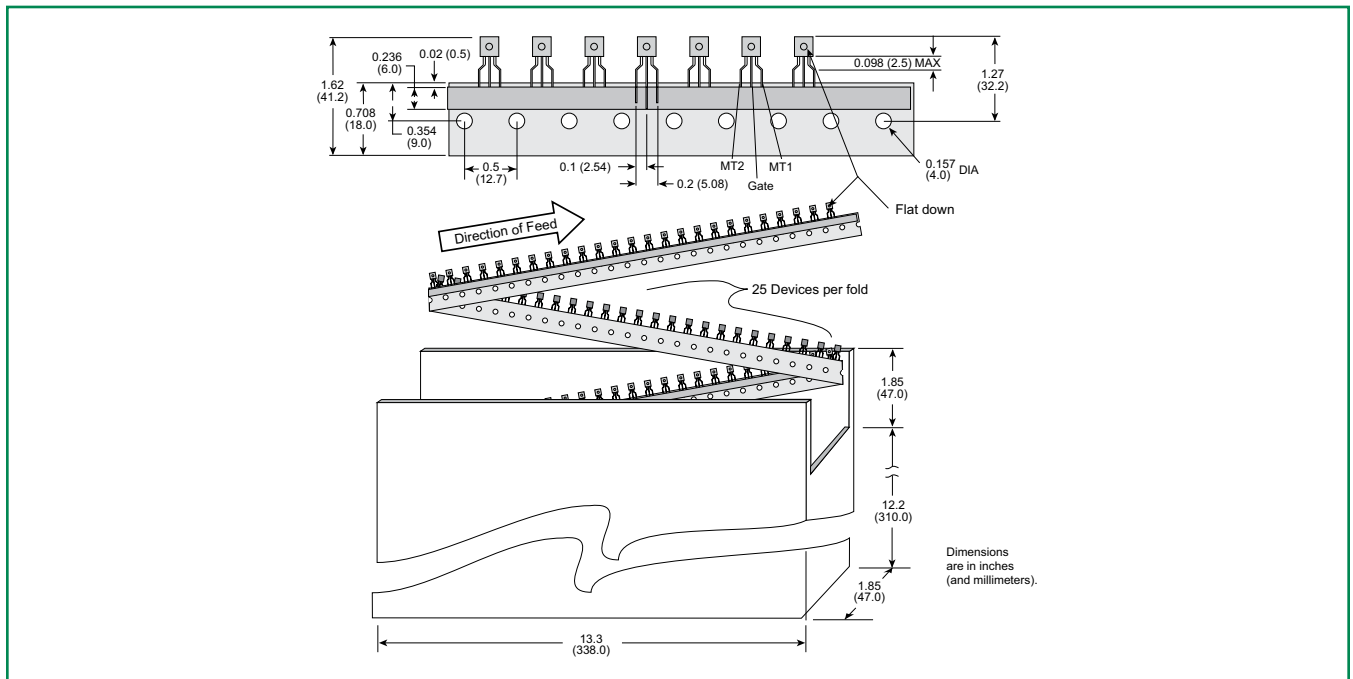

Compak Embossed Carrier Reel Pack (RP)

Meets all EIA-481-1 Standards

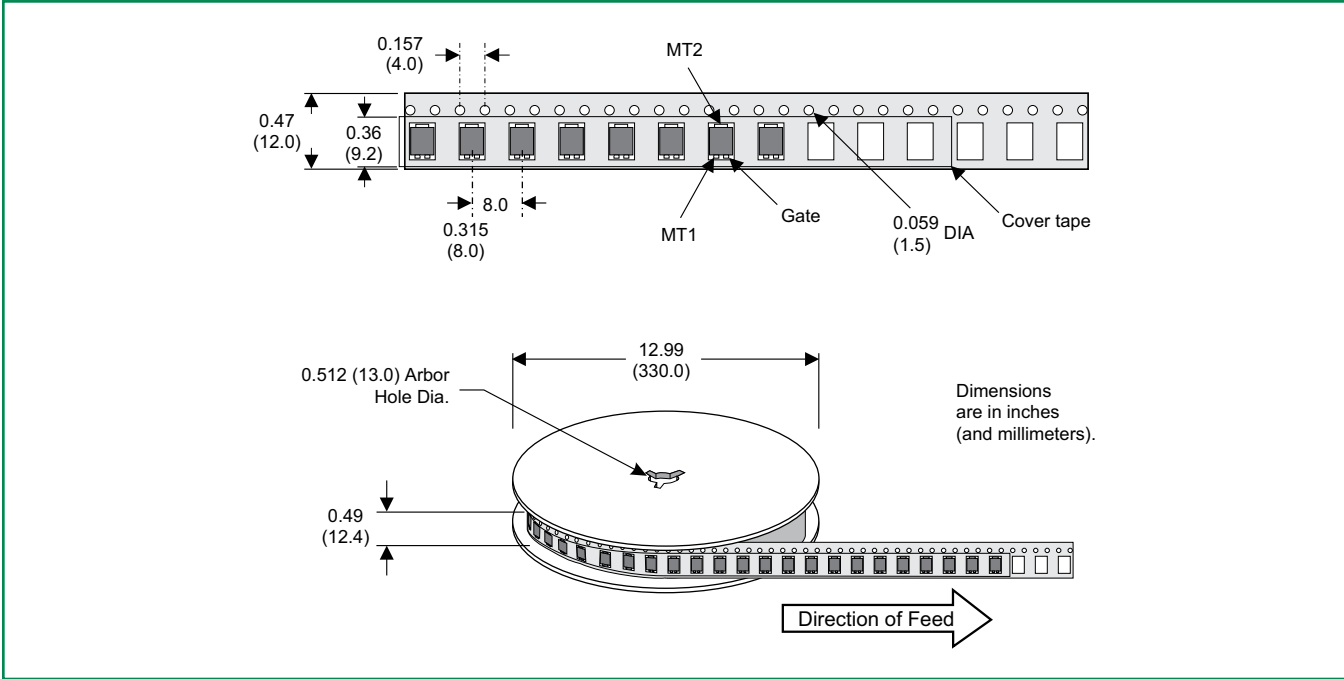

Part Numbering System

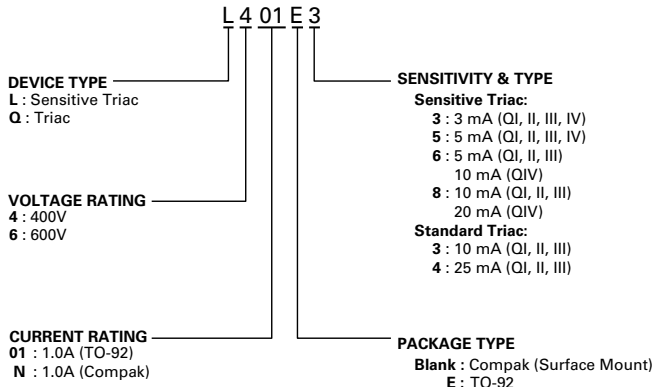

Part Marking System

TO-92 (E Package)

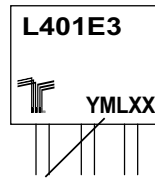

Date Code Marking
Y: Year Code
M: Month Code
L: Location Code
XX: Lot Serial Code

Compak (C Package)

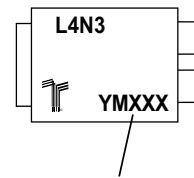

Date Code Marking
Y: Year Code
M: Month Code
XXX: Lot Trace Code

X-ON Electronics

Largest Supplier of Electrical and Electronic Components

Click to view similar products for [Triacs](#) category:

Click to view products by [Littelfuse](#) manufacturer:

Other Similar products are found below :

[ACST435-8B](#) [LIC01-215B-TR](#) [T2035H-6G](#) [BT137-600-0Q](#) [Z0410NF 1AA2](#) [Z0409MF0AA2](#) [Z0109NA 2AL2](#) [ACS108-8SA-AP](#) [ACS108-8SN-TR](#) [ACST1635T-8FP](#) [BCR20RM-30LA#B00](#) [T1205-600G-TR](#) [CMA60MT1600NHR](#) [ACS108-8TN-TR](#) [NTE5611](#) [NTE5612](#) [NTE5613](#) [NTE5621](#) [NTE5623](#) [NTE5629](#) [NTE5638-08](#) [NTE5688](#) [NTE5689](#) [NTE5690](#) [T1235T-8I](#) [BTA312-600CT.127](#) [T1210T-8G-TR](#) [T1210T-8G](#) [BT136S-600E,118](#) [Z0109NN0,135](#) [MAC4DLM-1G](#) [BT137-600E,127](#) [BT137X-600D](#) [BT148W-600R,115](#) [BT258-500R,127](#) [BTA08-800BW3G](#) [BTA140-800,127](#) [BTA30-600CW3G](#) [BTA30-600CW3G](#) [BTB08-800BW3G](#) [BTB16-600CW3G](#) [BTB16-600CW3G](#) [Z0405M-0AA2](#) [Z0410MF0AA2](#) [Z0109MN,135](#) [T825T-6I](#) [T1635T-6I](#) [T1220T-6I](#) [NTE5638](#) [TYN612MRG](#)