

LJxx04xx & QJxx04xx Series

4 Amp High Temperature Sensitive & Standard Triacs

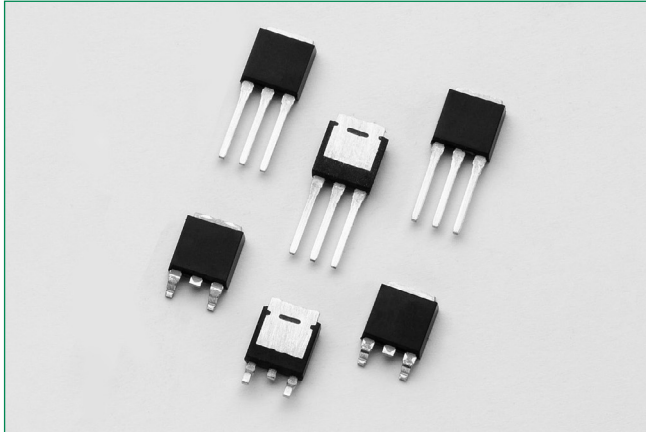

Additional Information



Resources



Accessories



Samples

Main Features

| Symbol | Value | Unit |
|-------------------|------------|------|
| $I_{T(RMS)}$ | 4 | A |
| V_{DRM}/V_{RRM} | 400 or 600 | V |
| $I_{GT(Q1)}$ | 10 to 25 | mA |

Description

This 4 A High Temperature Triac solid state switch series is designed for AC switching and phase control applications such as motor speed and temperature modulation controls, lighting controls, and static switching relays.

Sensitive type components guarantee gate control in Quadrants I & IV needed for digital control circuitry.

Standard type components normally operate in Quadrants I & III triggered from AC line.

Features & Benefits

- 150°C maximum junction temperature
- Voltage capability up to 600V
- Surge capability up to 48A at 60HZ half cycle
- Solid-state switching eliminates arcing or contact bounce that create voltage transients
- No contacts to wear out from reaction of switching events
- Restricted (or limited) RFI generation, depending on activation point of sine wave
- Requires only a short gate activation pulse in each half-cycle
- Halogen free and RoHS compliant

Applications

Typical applications are AC solid-state switches, power tools, home/brown goods and white goods appliances.

Sensitive gate Triacs can be directly driven by microprocessor or popular opto-couplers/isolators.

Internally constructed isolated packages are offered for ease of heat sinking with highest isolation voltage.

Schematic Symbol

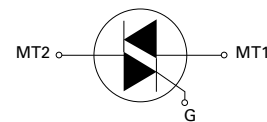

Absolute Maximum Ratings – Sensitive Triacs (4 Quadrants)

| Symbol | Parameter | Value | Unit |
|-------------------|--|---|----------------------|
| V_{DSM}/V_{RSM} | Peak non-repetitive blocking voltage | PW=100 μ s | 700 V |
| $I_{T(RMS)}$ | RMS on-state current (full sine wave) | LJxx04Vy/LJxx04Dy $T_c = 135^\circ\text{C}$ | 4 A |
| I_{TSM} | Non repetitive surge peak on-state current (full cycle, T_j initial = 25°C) | f = 50 Hz t = 20 ms | 40 A |
| | | f = 60 Hz t = 16.7 ms | 48 A |
| I^2t | I^2t Value for fusing | $t_p = 8.3$ ms | 9.5 A ² s |
| di/dt | Critical rate of rise of on-state current ($I_G = 50$ mA with ≤ 0.1 μ s rise time) | f = 60 Hz $T_j = 150^\circ\text{C}$ | 50 A/ μ s |
| I_{GTM} | Peak gate trigger current | $t_p = 20$ μ s $T_j = 150^\circ\text{C}$ | 4 A |
| $P_{G(AV)}$ | Average gate power dissipation | $T_j = 150^\circ\text{C}$ | 0.3 W |
| T_{stg} | Storage temperature range | | -40 to 150 °C |
| T_j | Operating junction temperature range | | -40 to 150 °C |

Note: xx=voltage/10, y = sensitivity

LJxx04xx & QJxx04xx Series

4 Amp High Temperature Sensitive & Standard Triacs

Absolute Maximum Ratings – Standard Triacs

| Symbol | Parameter | Value | Unit |
|-------------------|---|--|-----------------------------|
| V_{DSM}/N_{RSM} | Peak non-repetitive blocking voltage | PW=100 μ s | 700 V |
| $I_{T(RMS)}$ | RMS on-state current (full sine wave) | QJxx04Vy/QJxx04Dy $T_C = 135^\circ\text{C}$ | 4 A |
| I_{TSM} | Non repetitive surge peak on-state current (full cycle, T_J initial = 25°C) | f = 50 Hz t = 20 ms | 40 A |
| | | f = 60 Hz t = 16.7 ms | 48 A |
| I^2t | I^2t Value for fusing | $t_p = 8.3$ ms | 9.5 A ² s |
| di/dt | Critical rate of rise of on-state current ($I_G = 50\text{mA}$ with $\leq 0.1\mu\text{s}$ rise time) | f = 60 Hz $T_J = 150^\circ\text{C}$ | 50 A/ μ s |
| I_{GTM} | Peak gate trigger current | $t_p = 20\mu\text{s}$ $T_J = 150^\circ\text{C}$ | 4 A |
| $P_{G(AV)}$ | Average gate power dissipation | $T_J = 150^\circ\text{C}$ | 0.3 W |
| T_{stg} | Storage temperature range | | -40 to 150 $^\circ\text{C}$ |
| T_J | Operating junction temperature range | | -40 to 150 $^\circ\text{C}$ |

Note: xx=voltage/10, y = sensitivity

Electrical Characteristics ($T_J = 25^\circ\text{C}$, unless otherwise specified) – Sensitive Triac (4 Quadrants)

| Symbol | Test Conditions | Quadrant | LJxx04x8 | Unit |
|----------|---|--------------|----------|---------------|
| I_{GT} | $V_D = 12\text{V}$ $R_L = 60\ \Omega$ | I – II – III | 10 | mA |
| | | IV | 20 | |
| V_{GT} | $V_D = 12\text{V}$ $R_L = 60\ \Omega$ | ALL | MAX. | 1.3 V |
| V_{GD} | $V_D = V_{DRM}$ $R_L = 3.3\ \text{k}\Omega$ $T_J = 150^\circ\text{C}$ | ALL | MIN. | 0.2 V |
| I_H | $I_T = 100\text{mA}$ | | MAX. | 20 mA |
| dv/dt | $V_D = V_{DRM}$ Gate Open $T_J = 150^\circ\text{C}$ | 400V | TYP. | 75 V/ μ s |
| | | 600V | | 45 V/ μ s |
| (dv/dt)c | (di/dt)c = 2.16 A/ms $T_J = 150^\circ\text{C}$ | | TYP. | 1 V/ μ s |
| t_{gt} | $I_G = 2 \times I_{GT}$ PW = 15 μ s $I_T = 5.6$ A(pk) | | TYP. | 10 μ s |

Note: xx=voltage/10, x = package

Electrical Characteristics ($T_J = 25^\circ\text{C}$, unless otherwise specified) – Standard Triac

| Symbol | Test Conditions | Quadrant | QJxx04x3 | QJxx04x4 | Unit |
|----------|---|--------------|----------|----------|----------------|
| I_{GT} | $V_D = 12\text{V}$ $R_L = 60\ \Omega$ | I – II – III | MAX. | 10 | mA |
| | | IV | TYP. | 25 | |
| V_{GT} | $V_D = 12\text{V}$ $R_L = 60\ \Omega$ | I – II – III | MAX. | 1.3 | V |
| V_{GD} | $V_D = V_{DRM}$ $R_L = 3.3\ \text{k}\Omega$ $T_J = 150^\circ\text{C}$ | ALL | MIN. | 0.2 | V |
| I_H | $I_T = 200\text{mA}$ | | MAX. | 20 | 30 mA |
| dv/dt | $V_D = V_{DRM}$ Gate Open $T_J = 150^\circ\text{C}$ | 400V | MIN. | 75 | 150 V/ μ s |
| | | 600V | | 45 | 100 V/ μ s |
| (dv/dt)c | (di/dt)c = 2.16 A/ms $T_J = 150^\circ\text{C}$ | | TYP. | 2 | V/ μ s |
| t_{gt} | $I_G = 2 \times I_{GT}$ PW = 15 μ s $I_T = 5.6$ A(pk) | | TYP. | 10 | 15 μ s |

Note: xx=voltage/10, x = package

LJxx04xx & QJxx04xx Series

4 Amp High Temperature Sensitive & Standard Triacs

Static Characteristics ($T_J = 25^\circ\text{C}$, unless otherwise specified)

| Symbol | Test Conditions | | Value | Unit | | |
|------------------------|---|------|---------------------------|---------------------------|-----|---------------|
| V_{TM} | $I_{TM} = 5.6\text{A}$ $t_p = 380\ \mu\text{s}$ | MAX. | 1.40 | V | | |
| I_{DRM} I_{RRM} | $V_{DRM} = V_{RRM}$ | MAX. | LJxx04xy | $T_J = 25^\circ\text{C}$ | 5 | μA |
| | | | | $T_J = 125^\circ\text{C}$ | 0.5 | mA |
| | | | $T_J = 150^\circ\text{C}$ | 3 | | |
| | | | QJxx04xy | $T_J = 25^\circ\text{C}$ | 5 | μA |
| | | | | $T_J = 125^\circ\text{C}$ | 0.5 | mA |
| | | | | $T_J = 150^\circ\text{C}$ | 3 | |

Note: xx=voltage/10, x = package, y = sensitivity

Thermal Resistances

| Symbol | Parameter | Value | Unit |
|------------------|-----------------------|----------------------------|------|
| $R_{\theta(JC)}$ | Junction to case (AC) | LJ/QJxx04Dy | 1.5 |
| | | LJ/QJxx04Vy | 1.5 |
| $R_{\theta(JA)}$ | Junction to ambient | LJ/QJxx04Vy LJ/QJxx04Dy | 70 |

Note: xx=voltage/10, y = sensitivity

Figure 1:
Definition of Quadrants

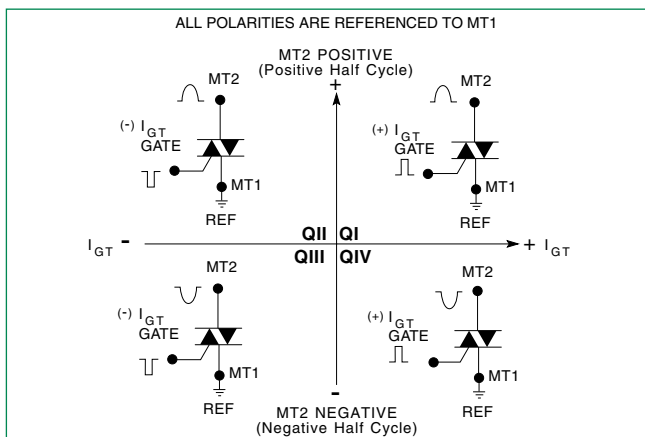
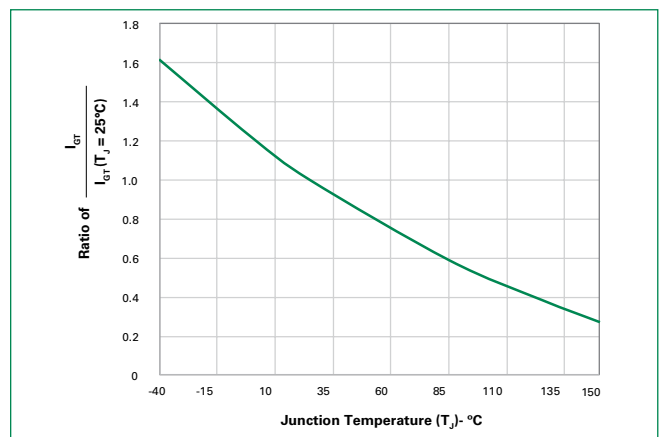

Figure 2:
Normalized DC Gate Trigger Current for All Quadrants vs. Junction Temperature



LJxx04xx & QJxx04xx Series

4 Amp High Temperature Sensitive & Standard Triacs

Figure 3:
Normalized DC Holding Current vs. Junction Temperature

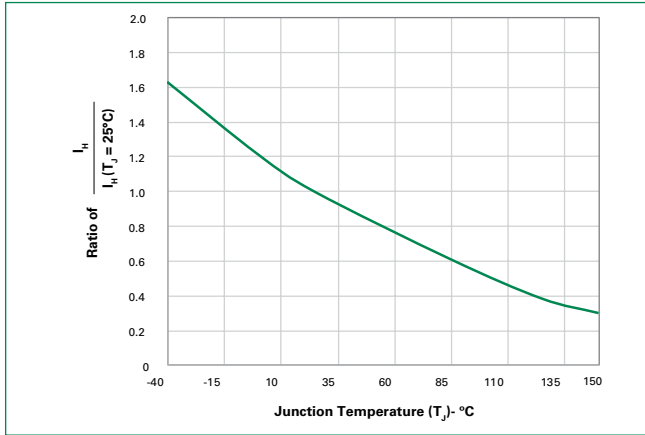

Figure 4:
Normalized DC Gate Trigger Voltage for All Quadrants vs. Junction Temperature

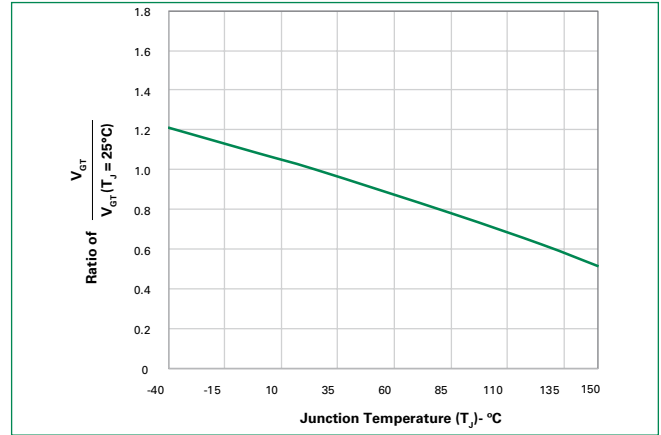

Figure 5:
Power Dissipation (Typical) vs. RMS On-State Current

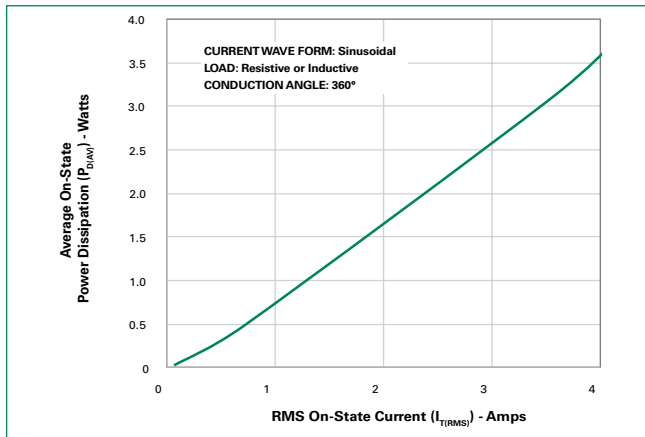

Figure 6:
Maximum Allowable Case Temperature vs. On-State Current

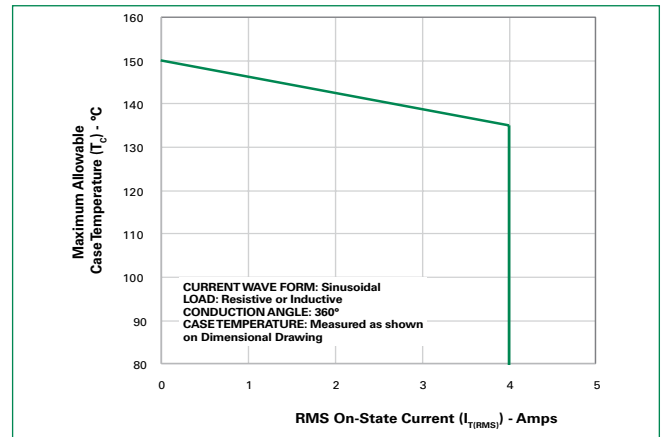
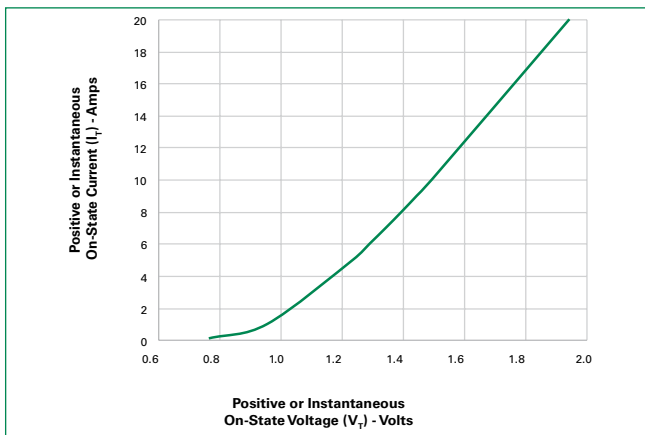

Figure 7:
On-State Current vs. On-State Voltage (Typical)



LJxx04xx & QJxx04xx Series

4 Amp High Temperature Sensitive & Standard Triacs

Figure 8: Surge Peak On-State Current vs. Number of Cycles

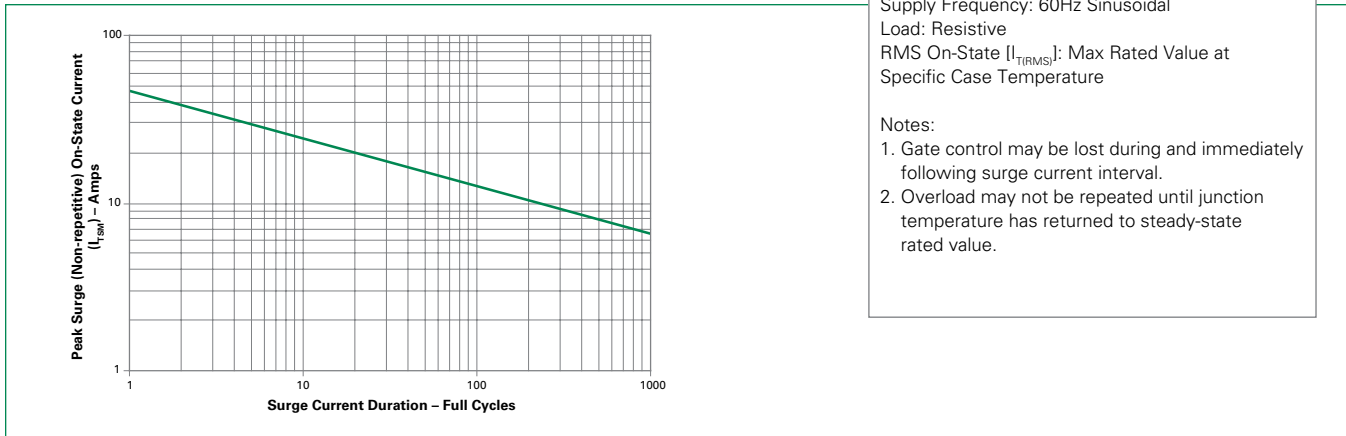

Soldering Parameters

| | | |
|--|------------------------------------|------------------|
| Reflow Condition | Pb – Free assembly | |
| Pre Heat | - Temperature Min ($T_{s(min)}$) | 150°C |
| | - Temperature Max ($T_{s(max)}$) | 200°C |
| | - Time (min to max) (t_s) | 60 – 120 secs |
| Average ramp up rate (Liquidus Temp) (T_L) to peak | 3°C/second max | |
| $T_{s(max)}$ to T_L - Ramp-up Rate | 3°C/second max | |
| Reflow | - Temperature (T_L) (Liquidus) | 217°C |
| | - Time (t_r) | 60 – 150 seconds |
| Peak Temperature (T_p) | 260 ^{+0/-5} °C | |
| Time within 5°C of actual peak Temperature (t_p) | 30 seconds max. | |
| Ramp-down Rate | 6°C/second max | |
| Time 25°C to peak Temperature (T_p) | 8 minutes max. | |
| Do not exceed | 280°C | |

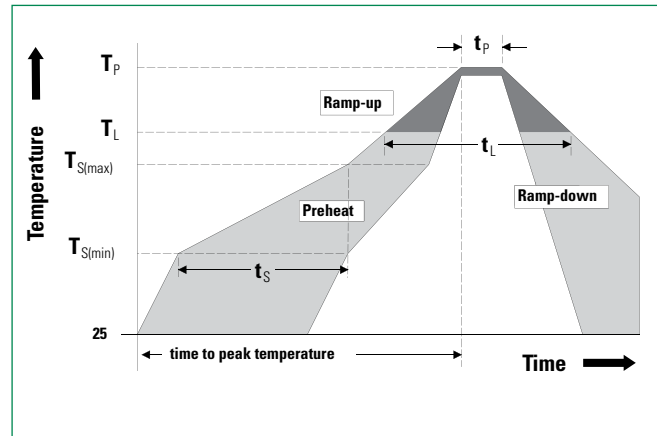

Physical Specifications

| | |
|--------------------------|--|
| Terminal Finish | 100% Matte Tin-plated |
| Body Material | UL Recognized compound meeting flammability rating V-0 |
| Terminal Material | Copper Alloy |

Design Considerations

Careful selection of the correct component for the application's operating parameters and environment will go a long way toward extending the operating life of the Thyristor. Good design practice should limit the maximum continuous current through the main terminals to 75% of the component rating. Other ways to ensure long life for a power discrete semiconductor are proper heat sinking and selection of voltage ratings for worst case conditions. Overheating, overvoltage (including dv/dt), and surge currents are the main killers of semiconductors. Correct mounting, soldering, and forming of the leads also help protect against component damage.

Environmental Specifications

| Test | Specifications and Conditions |
|---|--|
| AC Blocking (V_{DRM}) | MIL-STD-750, M-1040, Cond A Applied Peak AC voltage @ 150°C for 1008 hours |
| Temperature Cycling | MIL-STD-750, M-1051, 100 cycles; -55°C to +150°C; 15-min dwell-time |
| Temperature/Humidity | EIA / JEDEC, JESD22-A101 1008 hours; 160V - DC; 85°C; 85% rel humidity |
| High Temp Storage | MIL-STD-750, M-1031, 1008 hours; 150°C |
| Low-Temp Storage | 1008 hours; -40°C |
| Resistance to Solder Heat | MIL-STD-750 Method 2031 |
| Solderability | ANSI/J-STD-002, category 3, Test A |
| Lead Bend | MIL-STD-750, M-2036 Cond E |

LJxx04xx & QJxx04xx Series

4 Amp High Temperature Sensitive & Standard Triacs

Dimensions – TO-251AA (V-Package) – V-PAK Through Hole

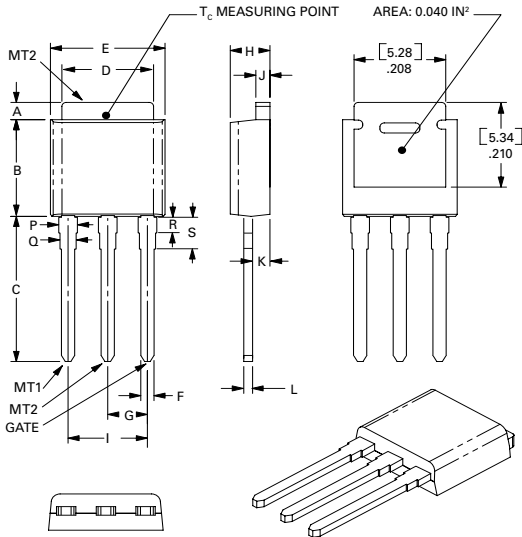

| Dimension | Inches | | | Millimeters | | |
|-----------|--------|-------|-------|-------------|------|------|
| | Min | Typ | Max | Min | Typ | Max |
| A | 0.037 | 0.040 | 0.043 | 0.94 | 1.01 | 1.09 |
| B | 0.235 | 0.242 | 0.245 | 5.97 | 6.15 | 6.22 |
| C | 0.350 | 0.361 | 0.375 | 8.89 | 9.18 | 9.53 |
| D | 0.205 | 0.208 | 0.213 | 5.21 | 5.29 | 5.41 |
| E | 0.255 | 0.262 | 0.265 | 6.48 | 6.66 | 6.73 |
| F | 0.027 | 0.031 | 0.033 | 0.69 | 0.80 | 0.84 |
| G | 0.087 | 0.090 | 0.093 | 2.21 | 2.28 | 2.36 |
| H | 0.085 | 0.092 | 0.095 | 2.16 | 2.34 | 2.41 |
| I | 0.176 | 0.180 | 0.184 | 4.47 | 4.57 | 4.67 |
| J | 0.018 | 0.020 | 0.023 | 0.46 | 0.51 | 0.58 |
| K | 0.035 | 0.037 | 0.039 | 0.90 | 0.95 | 1.00 |
| L | 0.018 | 0.020 | 0.023 | 0.46 | 0.52 | 0.58 |
| P | 0.042 | 0.047 | 0.052 | 1.06 | 1.20 | 1.32 |
| Q | 0.034 | 0.039 | 0.044 | 0.86 | 1.00 | 1.11 |
| R | 0.034 | 0.039 | 0.044 | 0.86 | 1.00 | 1.11 |
| S | 0.074 | 0.079 | 0.084 | 1.86 | 2.00 | 2.11 |

Dimensions – TO-252AA (D-Package) – D-PAK Surface Mount

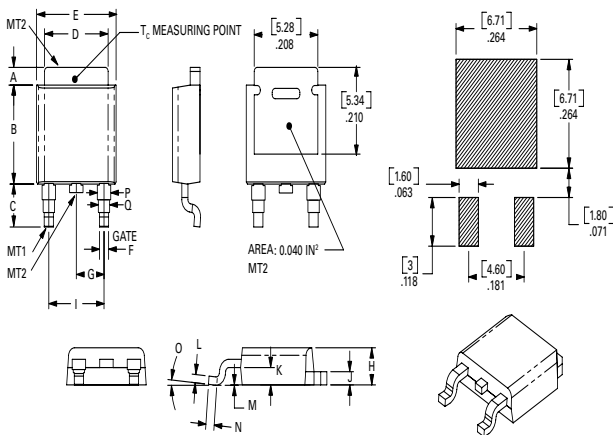

| Dimension | Inches | | | Millimeters | | |
|-----------|--------|-------|-------|-------------|------|------|
| | Min | Typ | Max | Min | Typ | Max |
| A | 0.037 | 0.040 | 0.043 | 0.94 | 1.01 | 1.09 |
| B | 0.235 | 0.243 | 0.245 | 5.97 | 6.16 | 6.22 |
| C | 0.106 | 0.108 | 0.113 | 2.69 | 2.74 | 2.87 |
| D | 0.205 | 0.208 | 0.213 | 5.21 | 5.29 | 5.41 |
| E | 0.255 | 0.262 | 0.265 | 6.48 | 6.65 | 6.73 |
| F | 0.027 | 0.031 | 0.033 | 0.69 | 0.80 | 0.84 |
| G | 0.087 | 0.090 | 0.093 | 2.21 | 2.28 | 2.36 |
| H | 0.085 | 0.092 | 0.095 | 2.16 | 2.33 | 2.41 |
| I | 0.176 | 0.179 | 0.184 | 4.47 | 4.55 | 4.67 |
| J | 0.018 | 0.020 | 0.023 | 0.46 | 0.51 | 0.58 |
| K | 0.035 | 0.037 | 0.039 | 0.90 | 0.95 | 1.00 |
| L | 0.018 | 0.020 | 0.023 | 0.46 | 0.51 | 0.58 |
| M | 0.000 | 0.000 | 0.004 | 0.00 | 0.00 | 0.10 |
| N | 0.021 | 0.026 | 0.027 | 0.53 | 0.67 | 0.69 |
| O | 0° | 0° | 5° | 0° | 0° | 5° |
| P | 0.042 | 0.047 | 0.052 | 1.06 | 1.20 | 1.32 |
| Q | 0.034 | 0.039 | 0.044 | 0.86 | 1.00 | 1.11 |

LJxx04xx & QJxx04xx Series

4 Amp High Temperature Sensitive & Standard Triacs

Product Selector

| Part Number | Voltage | | Gate Sensitivity Quadrants | | Type | Package |
|-------------|---------|------|----------------------------|------|-----------------|--------------|
| | 400V | 600V | I – II – III | IV | | |
| LJxx04D8 | x | x | 10mA | 20mA | Sensitive Triac | TO-252 D-PAK |
| LJxx04V8 | x | x | 10mA | 20mA | Sensitive Triac | TO-251 V-PAK |
| QJxx04D3 | x | x | 10mA | 25mA | Standard Triac | TO-252 D-PAK |
| QJxx04V3 | x | x | 10mA | 25mA | Standard Triac | TO-251 V-PAK |
| QJxx04D4 | x | x | 25mA | 50mA | Standard Triac | TO-252 D-PAK |
| QJxx04V4 | x | x | 25mA | 50mA | Standard Triac | TO-251 V-PAK |

Note: xx=voltage/10

Packing Options

| Part Number | Marking | Weight | Packing Mode | Base Quantity |
|-------------|----------|--------|------------------|------------------|
| LJxx04D8TP | LJxx04D8 | 0.3g | Tube Pack | 750(75 per tube) |
| LJxx04D8RP | LJxx04D8 | 0.3g | Embossed Carrier | 2500 |
| LJxx04V8TP | LJxx04V8 | 0.4g | Tube Pack | 750(75 per tube) |
| QJxx04D3TP | QJxx04D3 | 0.3g | Tube Pack | 750(75 per tube) |
| QJxx04D3RP | QJxx04D3 | 0.3g | Embossed Carrier | 2500 |
| QJxx04V3TP | QJxx04V3 | 0.4g | Tube Pack | 750(75 per tube) |
| QJxx04D4TP | QJxx04D4 | 0.3g | Tube Pack | 750(75 per tube) |
| QJxx04D4RP | QJxx04D4 | 0.3g | Embossed Carrier | 2500 |
| QJxx04V4TP | QJxx04V4 | 0.4g | Tube Pack | 750(75 per tube) |

Note: xx=voltage/10

Part Numbering System

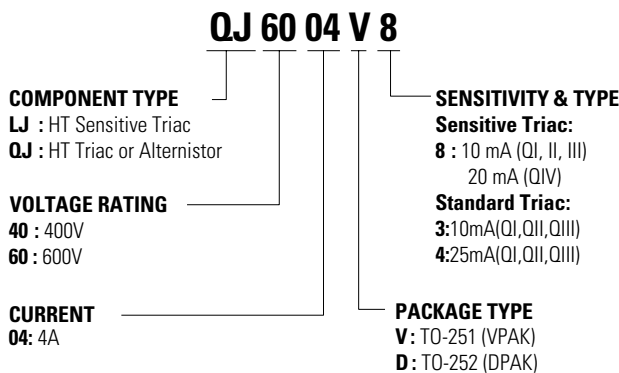

Part Marking System

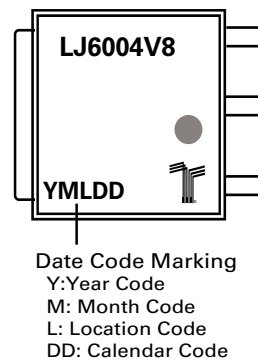

X-ON Electronics

Largest Supplier of Electrical and Electronic Components

Click to view similar products for [Triacs](#) category:

Click to view products by [Littelfuse](#) manufacturer:

Other Similar products are found below :

[CTA08-1000CW](#) [CTB24-800BW](#) [CTA08-1000C](#) [CTA12-800BWPT](#) [CTA16-1000B](#) [CTB24-800B](#) [BT137-600-0Q](#) [5615](#) [OT415Q](#) [2N6075A](#)
[NTE5629](#) [NTE5688](#) [CTB08-400CW](#) [D31410](#) [BTA425Z-800BTQ](#) [KS100N12](#) [TOPT16-800C0,127](#) [OT408,135](#) [BT134-800E](#) [BT136D](#)
[BTB16Q-600BW](#) [Z0409MF](#) [BTA04-600B](#) [BTA06-600BRG](#) [BTA06-800BWRG](#) [BTA08-600BRG](#) [BTA08-800B](#) [BT136-600,127](#)
[MAC97A6,116](#) [BT137-600E,127](#) [BTB16-600CW3G](#) [BTB16-600CW3G](#) [Z0109MN,135](#) [T825T-6I](#) [T1220T-6I](#) [NTE5638](#) [ACST1235-8FP](#)
[BT136X-600E,127](#) [MAC4DLM-1G](#) [BT134-600D,127](#) [BTA08-600BW3G](#) [NTE56008](#) [NTE56017](#) [NTE56018](#) [NTE56059](#) [NTE5608](#)
[NTE5609](#) [NTE5656](#) [NTE56020](#) [NTE56022](#)