

MG06400D-BN1MM Series 400A Dual IGBT



Features

- Ultra low loss
- High ruggedness
- High short circuit capability
- Positive temperature coefficient

Applications

- Motor drives
- Inverter
- Converter
- SMPS and UPS
- Welder
- Induction Heating

Agency Approvals

AGENCY	AGENCY FILE NUMBER
	E71639

Module Characteristics ($T_c = 25^\circ\text{C}$, unless otherwise specified)

Symbol	Parameters	Test Conditions	Min	Typ	Max	Unit
$T_{J(max)}$	Max. Junction Temperature				150	$^\circ\text{C}$
$T_{J(op)}$	Operating Temperature		-40		150	$^\circ\text{C}$
T_{STG}	Storage Temperature Range		-40		125	$^\circ\text{C}$
V_{isol}	Insulation Test Voltage	AC, t=1min		3000		V
CTI	Comparative Tracking Index	Module case exposed to 0.1% ammonium chloride solution per UL and IEC standards	350			V
R_{thJC}	Junction-to-Case Thermal Resistance	Per IGBT			0.09	K/W
R_{thJD}	Junction-to-Case Thermal Resistance	Per Inverse Diode			0.15	K/W
Torque	Module-to-Sink	Recommended (M6)	3		5	N-m
Torque	Module Electrodes	Recommended (M6)	2.5		5	N-m
Weight				310		g

Absolute Maximum Ratings ($T_c = 25^\circ\text{C}$, unless otherwise specified)

Symbol	Parameters	Test Conditions	Values	Unit
IGBT				
V_{CES}	Collector - Emitter Voltage		600	V
V_{GES}	Gate - Emitter Voltage		± 20	V
I_c	DC Collector Current	$T_c=25^\circ\text{C}$	460	A
		$T_c=50^\circ\text{C}$	400	A
I_{cpuls}	Pulsed Collector Current	$T_c=25^\circ\text{C}, t_p=1\text{ms}$	920	A
		$T_c=50^\circ\text{C}, t_p=1\text{ms}$	800	A
P_{tot}	Power Dissipation Per IGBT		1400	W

Free-Wheeling Diode

V_{RRM}	Repetitive Reverse Voltage		600	V
$I_{F(AV)}$	Average Forward Current	$T_c=25^\circ\text{C}$	400	A
		$T_c=50^\circ\text{C}$	320	A
$I_{F(RMS)}$	RMS Forward Current		570	A
I_{FSM}	Non-Repetitive Surge Forward Current	$T_j=45^\circ\text{C}, t=10\text{ms}, \text{Sine}$	1200	A
		$T_j=45^\circ\text{C}, t=8.3\text{ms}, \text{Sine}$	1320	A

Life Support Note:

Not Intended for Use in Life Support or Life Saving Applications

The products shown herein are not designed for use in life sustaining or life saving applications unless otherwise expressly indicated.

Electrical Characteristics ($T_c = 25^\circ\text{C}$, unless otherwise specified)

Symbol	Parameters	Test Conditions	Min	Typ	Max	Unit
IGBT						
$V_{GE(th)}$	Gate - Emitter Threshold Voltage	$V_{CE}=V_{GE}, I_C=8\text{mA}$	4.5	5.5	6.5	V
$V_{CE(sat)}$	Collector - Emitter Saturation Voltage	$I_C=400\text{A}, V_{GE}=15\text{V}, T_J=25^\circ\text{C}$		1.95	2.45	V
		$I_C=400\text{A}, V_{GE}=15\text{V}, T_J=125^\circ\text{C}$		2.2		V
I_{CES}	Collector Leakage Current	$V_{CE}=600\text{V}, V_{GE}=0\text{V}, T_J=25^\circ\text{C}$			1	mA
		$V_{CE}=600\text{V}, V_{GE}=0\text{V}, T_J=125^\circ\text{C}$		2		mA
I_{GES}	Gate Leakage Current	$V_{CE}=0\text{V}, V_{GE}=\pm 20\text{V}$	1.2		1.2	μA
R_{Gint}	Intergrated Gate Resistor			2.5		Ω
Q_{ge}	Gate Charge	$V_{CE}=300\text{V}, I_C=400\text{A}, V_{GE}=\pm 15\text{V}$		1.8		μC
C_{ies}	Input Capacitance	$V_{CE}=25\text{V}, V_{GE}=0\text{V}, f=1\text{MHz}$		18		nF
C_{oes}	Output Capacitance			1.8		nF
C_{res}	Reverse Transfer Capacitance			1.6		nF
$t_{d(on)}$	Turn - on Delay Time	$V_{CC}=300\text{V}$ $I_C=400\text{A}$ $R_G=3\Omega$ $V_{GE}=\pm 15\text{V}$ Inductive Load	$T_J=25^\circ\text{C}$		195	ns
			$T_J=125^\circ\text{C}$		220	ns
t_r	Rise Time		$T_J=25^\circ\text{C}$		65	ns
			$T_J=125^\circ\text{C}$		80	ns
$t_{d(off)}$	Turn - off Delay Time		$T_J=25^\circ\text{C}$		295	ns
			$T_J=125^\circ\text{C}$		350	ns
t_f	Fall Time		$T_J=25^\circ\text{C}$		45	ns
			$T_J=125^\circ\text{C}$		60	ns
E_{on}	Turn - on Energy		$T_J=25^\circ\text{C}$		6.5	mJ
			$T_J=125^\circ\text{C}$		10	mJ
E_{off}	Turn - off Energy	$T_J=25^\circ\text{C}$		9.5	mJ	
		$T_J=125^\circ\text{C}$		14.5	mJ	
Free-Wheeling Diode						
V_F	Forward Voltage	$I_F=400\text{A}, V_{GE}=0\text{V}, T_J=25^\circ\text{C}$		1.25	1.6	V
		$I_F=400\text{A}, V_{GE}=0\text{V}, T_J=125^\circ\text{C}$		1.2		V
T_{rr}	Reverse Recovery Time	$I_F=400\text{A}, V_R=300\text{V}$		249		ns
I_{RRM}	Reverse Recovery Charge	$d_F/dt=-2000\text{A}/\mu\text{s}$		214		A
Q_{rr}	Reverse Recovery Charge	$T_J=125^\circ\text{C}$		31		μC

Figure 1: Typical Output Characteristics

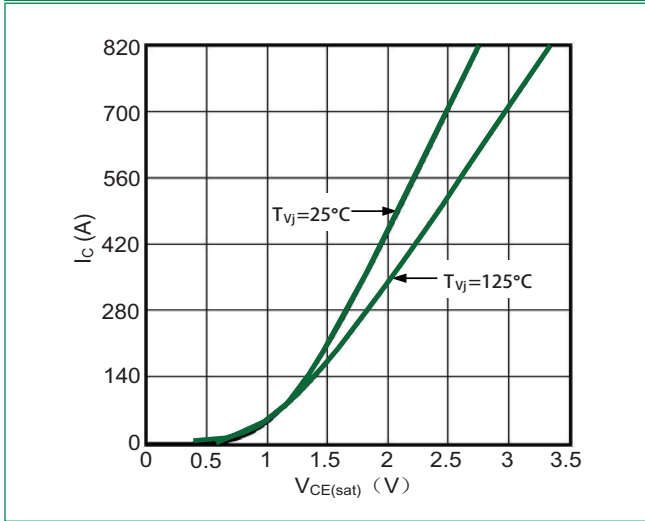

Figure 2: Typical Transfer Characteristics

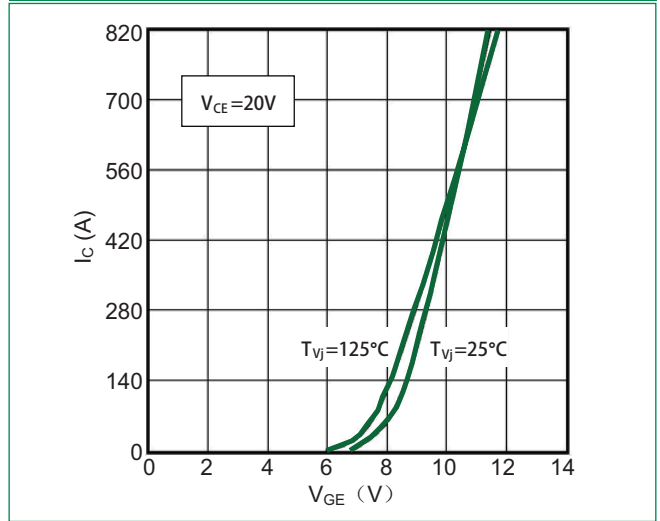

Figure 3: Switching Energy vs. Collector Current

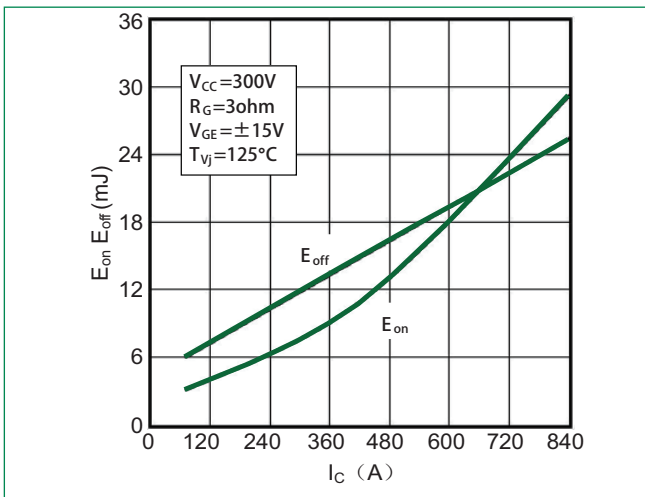

Figure 4: Switching Energy vs. Gate Resistor

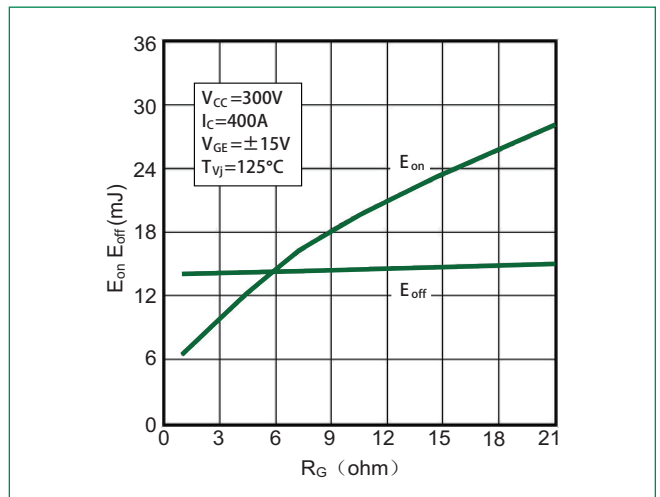

Figure 5: Switching Times vs. Collector Current

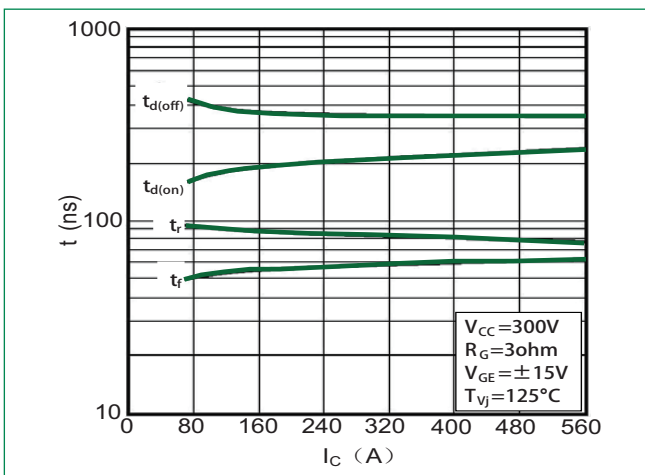

Figure 6: Switching Times vs. Gate Resistor

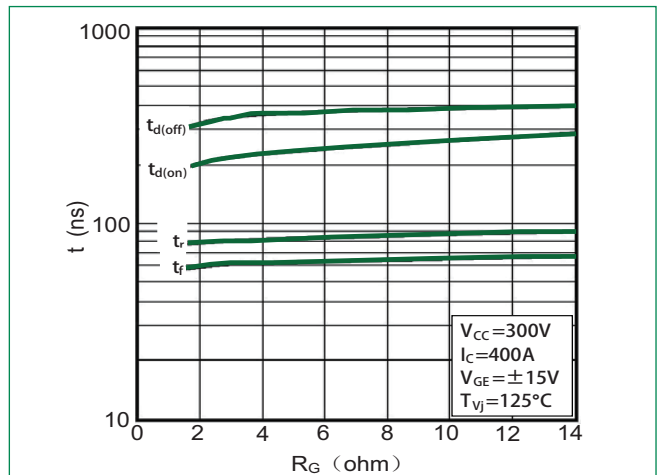

Figure 7: Diode Forward Characteristics

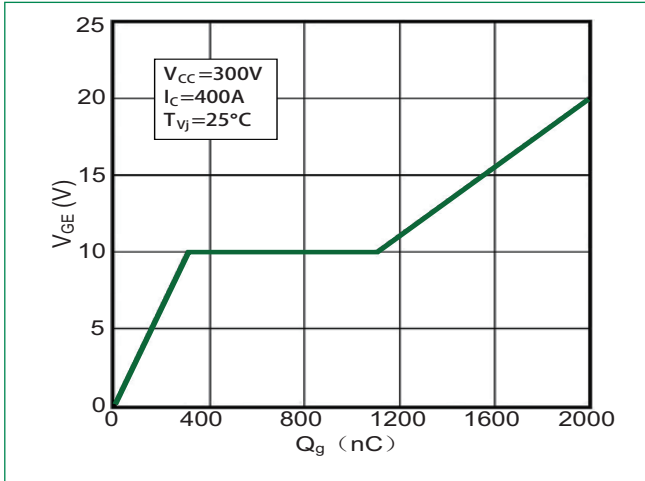

Figure 8: Typical Capacitances vs. V_{CE}

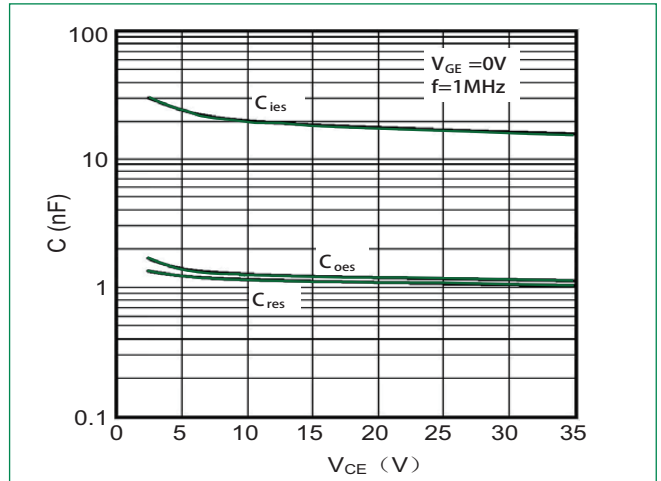

Figure 9: Reverse Biased Safe Operating Area

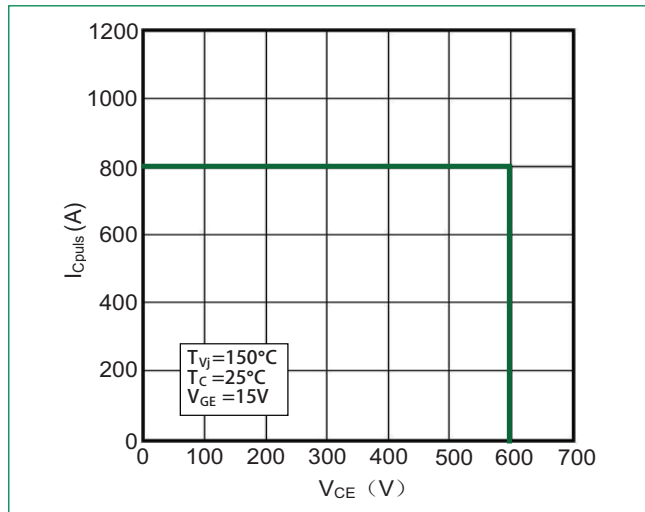

Figure 10: Short Circuit Safe Operating Area

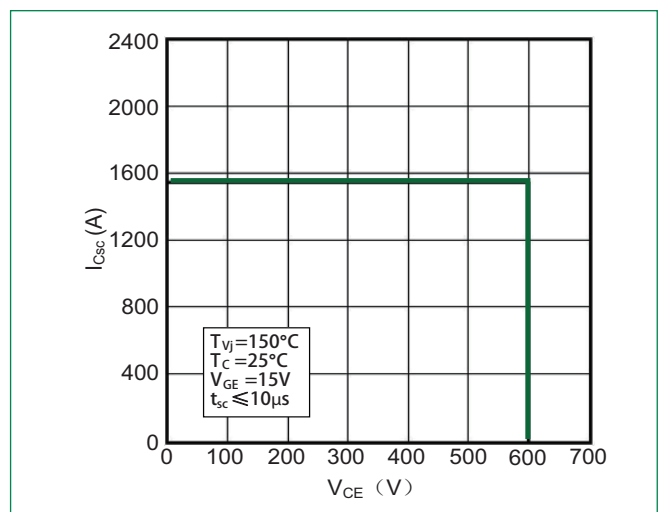

Figure 11: Rated Current vs. T_C

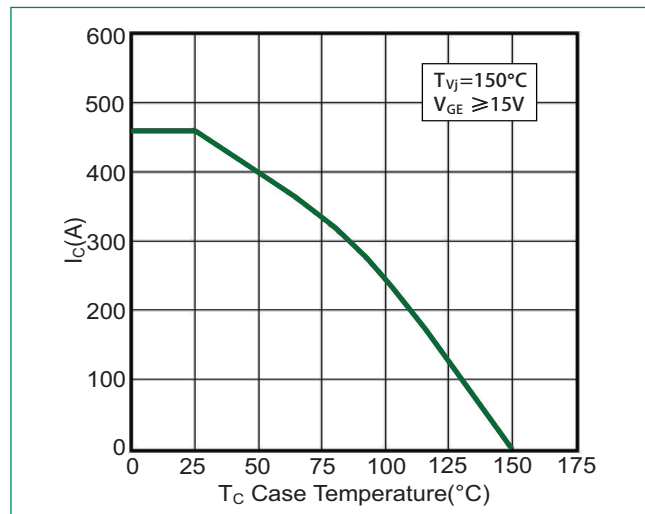

Figure 12: Diode Forward Characteristics

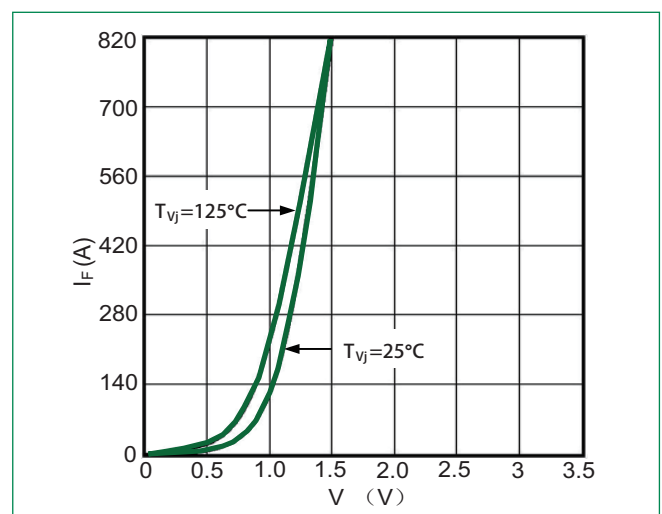

Figure 13: Transient Thermal Impedance of IGBT

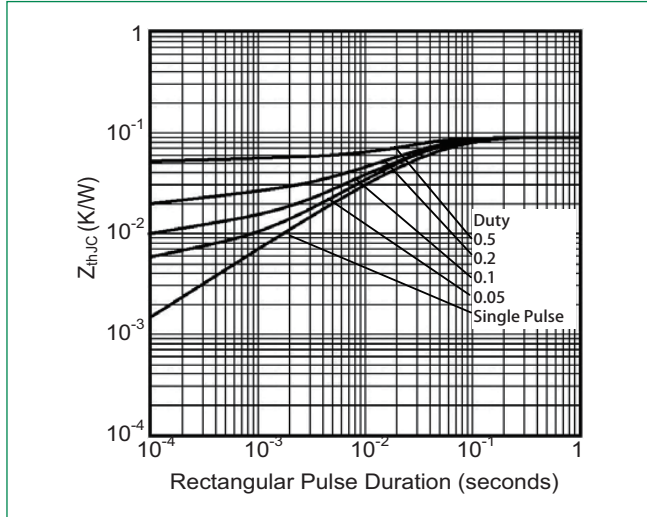
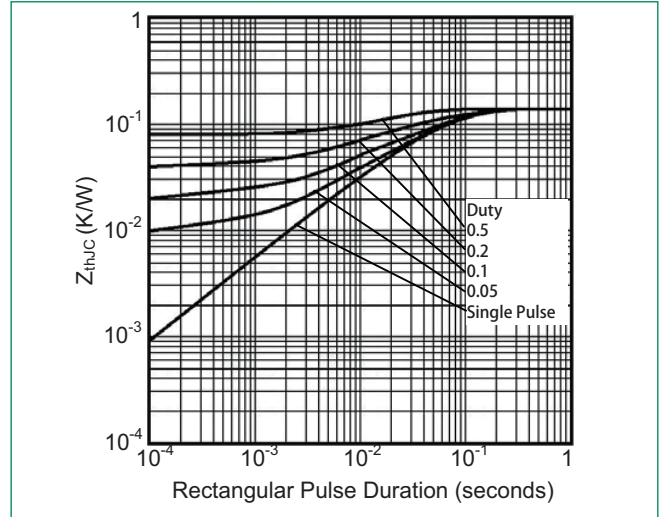
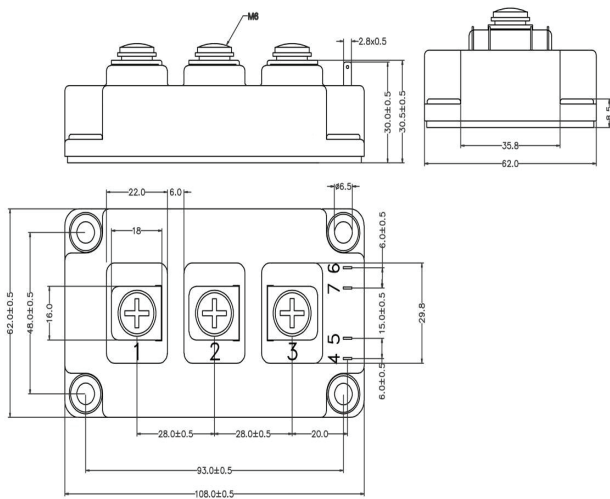

Figure 14: Transient Thermal Impedance of Diode



Dimensions-Package D



Circuit Diagram and Pin Assignment

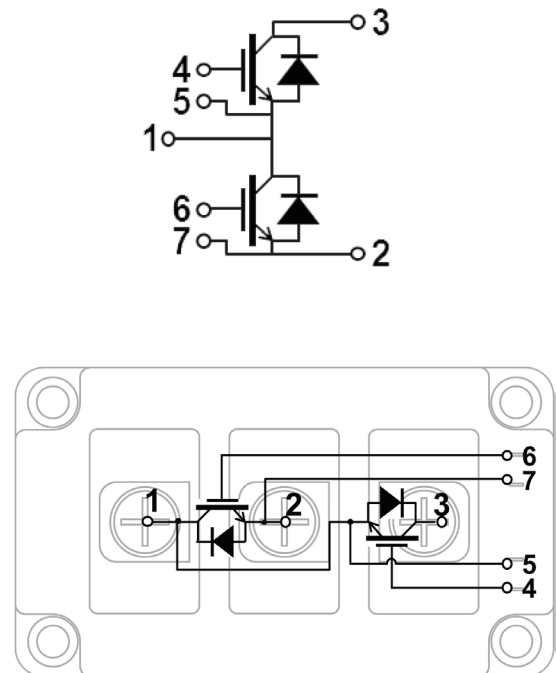

Packing Options

Part Number	Marking	Weight	Packing Mode	M.O.Q
MG06400D-BN1MM	MG06400D-BN1MM	310g	Bulk Pack	60

Part Numbering System

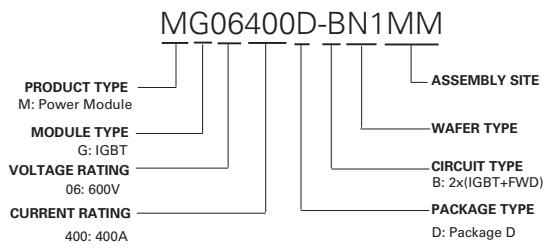

Part Marking System

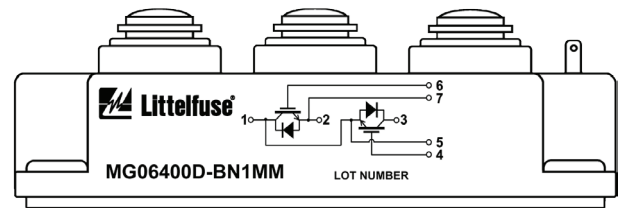

X-ON Electronics

Largest Supplier of Electrical and Electronic Components

Click to view similar products for [IGBT Modules category](#):

Click to view products by [Littelfuse manufacturer](#):

Other Similar products are found below :

[F3L400R07ME4_B22](#) [F4-50R07W2H3_B51](#) [FB15R06W1E3](#) [FB20R06W1E3_B11](#) [FD1000R33HE3-K](#) [FD400R33KF2C-K](#)
[FD401R17KF6C_B2](#) [FD-DF80R12W1H3_B52](#) [FF200R06YE3](#) [FF300R12KE4_E](#) [FF450R12ME4P](#) [FF600R12IP4V](#) [FP10R06W1E3_B11](#)
[FP20R06W1E3](#) [FP50R12KT3](#) [FP75R07N2E4_B11](#) [FS10R12YE3](#) [FS150R07PE4](#) [FS150R12PT4](#) [FS200R12KT4R](#) [FS50R07N2E4_B11](#)
[FZ1000R33HE3](#) [FZ1800R17KF4](#) [DD250S65K3](#) [DF1000R17IE4](#) [DF1000R17IE4D_B2](#) [DF1400R12IP4D](#) [DF200R12PT4_B6](#)
[DF400R07PE4R_B6](#) [BSM75GB120DN2_E3223c-Se](#) [F3L300R12ME4_B22](#) [F3L75R07W2E3_B11](#) [F4-50R12KS4_B11](#)
[F475R07W1H3B11ABOMA1](#) [FD1400R12IP4D](#) [FD200R12PT4_B6](#) [FD800R33KF2C-K](#) [FF1200R17KP4_B2](#) [FF300R17KE3_S4](#)
[FF300R17ME4_B11](#) [FF401R17KF6C_B2](#) [FF650R17IE4D_B2](#) [FF900R12IP4D](#) [FF900R12IP4DV](#) [STGIF7CH60TS-L](#) [FP50R07N2E4_B11](#)
[FS100R07PE4](#) [FS150R07N3E4_B11](#) [FS150R17N3E4](#) [FS150R17PE4](#)