

### MG1240H-XBN2MM

RoHS

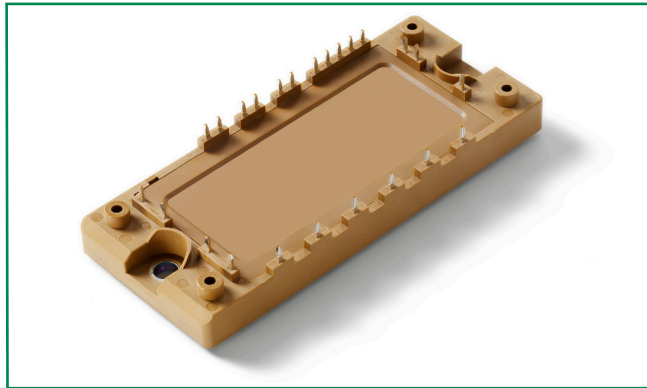

#### Features

- High level of integration—only one power semiconductor module required for the whole drive
- Low saturation voltage and positive temperature coefficient
- Fast switching and short tail current
- Free wheeling diodes with fast and soft reverse recovery
- Industry standard package with insulated copper base plate and soldering pins for PCB mounting
- Temperature sense included

#### Applications

- AC motor control
- Motion/servo control
- Inverter and power supplies

#### Module Characteristics ( $T_J = 25^\circ\text{C}$ , unless otherwise specified)

Symbol	Parameters	Test Conditions	Min	Typ	Max	Unit
$T_{J\max}$	Max. Junction Temperature				150	$^\circ\text{C}$
$T_{J\text{op}}$	Operating Temperature		-40		125	$^\circ\text{C}$
$T_{\text{stg}}$	Storage Temperature		-40		125	$^\circ\text{C}$
$V_{\text{isol}}$	Insulation Test Voltage	AC, t=1min		3000		V
CTI	Comparative Tracking Index		250			
$M_d$	Mounting Torque	Recommended (M5)	2.5		5	N·m
Weight				180		g

## Inverter Sector

#### Absolute Maximum Ratings ( $T_J = 25^\circ\text{C}$ , unless otherwise specified)

Symbol	Parameters	Test Conditions	Values	Unit
<b>IGBT</b>				
$V_{\text{CES}}$	Collector - Emitter Voltage	$T_J = 25^\circ\text{C}$	1200	V
$V_{\text{GES}}$	Gate - Emitter Voltage		$\pm 20$	V
$I_C$	DC Collector Current	$T_C = 25^\circ\text{C}$	55	A
		$T_C = 80^\circ\text{C}$	40	A
$I_{\text{CM}}$	Repetitive Peak Collector Current	$t_p = 1\text{ms}$	80	A
$P_{\text{tot}}$	Power Dissipation Per IGBT		195	W
<b>Diode</b>				
$V_{\text{RRM}}$	Repetitive Reverse Voltage	$T_J = 25^\circ\text{C}$	1200	V
$I_{\text{F(AV)}}$	Average Forward Current	$T_C = 25^\circ\text{C}$	55	A
		$T_C = 80^\circ\text{C}$	40	A
$I_{\text{FRM}}$	Repetitive Peak Forward Current	$t_p = 1\text{ms}$	80	A
$I^2t$		$T_J = 125^\circ\text{C}$ , t=10ms, $V_R = 0\text{V}$	300	$\text{A}^2\text{s}$

**Electrical and Thermal Specifications ( $T_J = 25^\circ\text{C}$ , unless otherwise specified)**

Symbol	Parameters	Test Conditions	Min	Typ	Max	Unit
<b>IGBT</b>						
$V_{GE(th)}$	Gate - Emitter Threshold Voltage	$V_{CE}=V_{GE}, I_C=1.5\text{mA}$	5.0	5.8	6.5	V
$V_{CE(sat)}$	Collector - Emitter Saturation Voltage	$I_C=40\text{A}, V_{GE}=15\text{V}, T_J=25^\circ\text{C}$		1.8		V
		$I_C=40\text{A}, V_{GE}=15\text{V}, T_J=125^\circ\text{C}$		2.05		V
$I_{ICES}$	Collector Leakage Current	$V_{CE}=1200\text{V}, V_{GE}=0\text{V}, T_J=25^\circ\text{C}$			0.25	mA
		$V_{CE}=1200\text{V}, V_{GE}=0\text{V}, T_J=125^\circ\text{C}$			2	mA
$I_{GES}$	Gate Leakage Current	$V_{CE}=0\text{V}, V_{GE}=\pm 15\text{V}, T_J=125^\circ\text{C}$	-400		400	nA
$R_{Gint}$	Integrated Gate Resistor			6.0		$\Omega$
$Q_{ge}$	Gate Charge	$V_{CE}=600\text{V}, I_C=40\text{A}, V_{GE}=\pm 15\text{V}$		0.33		$\mu\text{C}$
$C_{ies}$	Input Capacitance	$V_{CE}=25\text{V}, V_{GE}=0\text{V}, f=1\text{MHz}$		2.5		nF
$C_{res}$	Reverse Transfer Capacitance				0.11	
$t_{d(on)}$	Turn - on Delay Time	$V_{CC}=600\text{V}$ $I_C=40\text{A}$ $R_G=27\Omega$ $V_{GE}=\pm 15\text{V}$ Inductive Load	$T_J=25^\circ\text{C}$		90	ns
			$T_J=125^\circ\text{C}$		90	ns
$t_r$	Rise Time		$T_J=25^\circ\text{C}$		30	ns
			$T_J=125^\circ\text{C}$		50	ns
$t_{d(off)}$	Turn - off Delay Time		$T_J=25^\circ\text{C}$		420	ns
			$T_J=125^\circ\text{C}$		520	ns
$t_f$	Fall Time		$T_J=25^\circ\text{C}$		70	ns
			$T_J=125^\circ\text{C}$		90	ns
$E_{on}$	Turn - on Energy		$T_J=25^\circ\text{C}$		4.1	mJ
			$T_J=125^\circ\text{C}$		5.8	mJ
$E_{off}$	Turn - off Energy	$T_J=25^\circ\text{C}$		3.6	mJ	
		$T_J=125^\circ\text{C}$		4.2	mJ	
$I_{SC}$	Short Circuit Current	$t_{psc} \leq 10\mu\text{s}, V_{GE}=15\text{V}, T_J=125^\circ\text{C}, V_{CC}=900\text{V}$		160		A
$R_{thJC}$	Junction-to-Case Thermal Resistance (Per IGBT)				0.64	K/W
<b>Diode</b>						
$V_F$	Forward Voltage	$I_F=40\text{A}, V_{GE}=0\text{V}, T_J=25^\circ\text{C}$		1.80		V
		$I_F=40\text{A}, V_{GE}=0\text{V}, T_J=125^\circ\text{C}$		1.85		V
$t_{RR}$	Reverse Recovery Time	$I_F=40\text{A}, V_R=600\text{V}$ $di_p/dt=-400\text{A}/\mu\text{s}$ $T_J=125^\circ\text{C}$		240		ns
$I_{RRM}$	Max. Reverse Recovery Current			35		A
$E_{rec}$	Reverse Recovery Energy			2.8		mJ
$R_{thJCD}$	Junction-to-Case Thermal Resistance (Per Diode)				1.0	K/W

### Diode-Rectifier Absolute Maximum Ratings ( $T_J = 25^\circ\text{C}$ , unless otherwise specified)

Symbol	Parameters	Test Conditions	Values	Unit
$V_{RRM}$	Repetitive Reverse Voltage	$T_J=25^\circ\text{C}$	1600	V
$I_{F(RMS)}$	R.M.S. Forward Current Per Diode	$T_C=80^\circ\text{C}$	40	A
$I_{FSM}$	Non-Repetitive Surge Forward Current	$T_J=45^\circ\text{C}$ , $t=10\text{ms}$ , 50Hz	320	A
		$T_J=45^\circ\text{C}$ , $t=8.3\text{ms}$ , 60Hz	350	A
$I^2t$		$T_J=45^\circ\text{C}$ , $t=10\text{ms}$ , 50Hz	512	$\text{A}^2\text{s}$
		$T_J=45^\circ\text{C}$ , $t=8.3\text{ms}$ , 60Hz	612	$\text{A}^2\text{s}$

### Diode-Rectifier Electrical and Thermal Specifications ( $T_J = 25^\circ\text{C}$ , unless otherwise specified)

Symbol	Parameters	Test Conditions	Min	Typ	Max	Unit
$V_F$	Forward Voltage	$I_F=40\text{A}$ , $V_{GE}=0\text{V}$ , $T_J=25^\circ\text{C}$		1.2		V
		$I_F=40\text{A}$ , $V_{GE}=0\text{V}$ , $T_J=125^\circ\text{C}$		1.15		V
$I_R$	Reverse Leakage Current	$V_R=1600\text{V}$ , $T_J=25^\circ\text{C}$			50	$\mu\text{A}$
		$V_R=1600\text{V}$ , $T_J=125^\circ\text{C}$			1	mA
$R_{thJCD}$	Junction-to-Case Thermal Resistance (Per Diode)				1.0	$\text{K/W}$

### Brake-Chopper Absolute Maximum Ratings ( $T_J = 25^\circ\text{C}$ , unless otherwise specified)

Symbol	Parameters	Test Conditions	Values	Unit
<b>IGBT</b>				
$V_{CES}$	Collector - Emitter Voltage	$T_J=25^\circ\text{C}$	1200	V
$V_{GES}$	Gate - Emitter Voltage		$\pm 20$	V
$I_C$	DC Collector Current	$T_C=25^\circ\text{C}$	25	A
		$T_C=80^\circ\text{C}$	15	A
$I_{CM}$	Repetitive Peak Collector Current	$t_p=1\text{ms}$	30	A
$P_{tot}$	Power Dissipation Per IGBT		105	W
<b>Diode</b>				
$V_{RRM}$	Repetitive Reverse Voltage	$T_J=25^\circ\text{C}$	1200	V
$I_{F(AV)}$	Average Forward Current	$T_C=25^\circ\text{C}$	25	A
		$T_C=80^\circ\text{C}$	15	A
$I_{FRM}$	Repetitive Peak Forward Current	$t_p=1\text{ms}$	30	A
$I^2t$		$T_J=125^\circ\text{C}$ , $t=10\text{ms}$ , $V_R=0\text{V}$	60	$\text{A}^2\text{s}$

### Brake-Chopper Electrical and Thermal Specifications ( $T_J = 25^\circ\text{C}$ , unless otherwise specified)

Symbol	Parameters	Test Conditions	Min	Typ	Max	Unit
<b>IGBT</b>						
$V_{GE(th)}$	Gate - Emitter Threshold Voltage	$V_{CE}=V_{GE}, I_C=0.5\text{mA}$	5.0	5.8	6.5	V
$V_{CE(sat)}$	Collector - Emitter Saturation Voltage	$I_C=15\text{A}, V_{GE}=15\text{V}, T_J=25^\circ\text{C}$		1.7		V
		$I_C=15\text{A}, V_{GE}=15\text{V}, T_J=125^\circ\text{C}$		1.9		V
$I_{ICES}$	Collector Leakage Current	$V_{CE}=1200\text{V}, V_{GE}=0\text{V}, T_J=25^\circ\text{C}$			50	$\mu\text{A}$
		$V_{CE}=1200\text{V}, V_{GE}=0\text{V}, T_J=125^\circ\text{C}$			1	mA
$I_{GES}$	Gate Leakage Current	$V_{CE}=0\text{V}, V_{GE}=\pm 15\text{V}, T_J=125^\circ\text{C}$	-400		400	nA
$R_{Gint}$	Integrated Gate Resistor			0		$\Omega$
$Q_{ge}$	Gate Charge	$V_{CE}=600\text{V}, I_C=15\text{A}, V_{GE}=\pm 15\text{V}$		0.15		$\mu\text{C}$
$C_{ies}$	Input Capacitance	$V_{CE}=25\text{V}, V_{GE}=0\text{V}, f=1\text{MHz}$		1.1		nF
$C_{res}$	Reverse Transfer Capacitance			0.05		nF
$t_{d(on)}$	Turn - on Delay Time	$V_{CC}=600\text{V}$ $I_C=15\text{A}$ $R_G=62\Omega$ $V_{GE}=\pm 15\text{V}$ Inductive Load	$T_J=25^\circ\text{C}$	90		ns
			$T_J=125^\circ\text{C}$	90		ns
$t_r$	Rise Time		$T_J=25^\circ\text{C}$	25		ns
			$T_J=125^\circ\text{C}$	30		ns
$t_{d(off)}$	Turn - off Delay Time		$T_J=25^\circ\text{C}$	420		ns
			$T_J=125^\circ\text{C}$	520		ns
$t_f$	Fall Time		$T_J=25^\circ\text{C}$	90		ns
			$T_J=125^\circ\text{C}$	120		ns
$E_{on}$	Turn - on Energy		$T_J=25^\circ\text{C}$	1.4		mJ
			$T_J=125^\circ\text{C}$	2.0		mJ
$E_{off}$	Turn - off Energy	$T_J=25^\circ\text{C}$	1.0		mJ	
		$T_J=125^\circ\text{C}$	1.2		mJ	
$I_{SC}$	Short Circuit Current	$t_{psc} \leq 10\mu\text{s}, V_{GE}=15\text{V}, T_J=125^\circ\text{C}, V_{CC}=900\text{V}$		55		A
$R_{thJC}$	Junction-to-Case Thermal Resistance (Per IGBT)				1.2	K/W
<b>Diode</b>						
$V_F$	Forward Voltage	$I_F=15\text{A}, V_{GE}=0\text{V}, T_J=25^\circ\text{C}$		1.65		V
		$I_F=15\text{A}, V_{GE}=0\text{V}, T_J=125^\circ\text{C}$		1.75		V
$t_{RR}$	Reverse Recovery Time	$I_F=15\text{A}, V_R=600\text{V}$ $di_p/dt=-400\text{A}/\mu\text{s}$ $T_J=125^\circ\text{C}$		150		ns
$I_{RRM}$	Max. Reverse Recovery Current			15		A
$E_{rec}$	Reverse Recovery Energy			0.6		mJ
$R_{thJCD}$	Junction-to-Case Thermal Resistance (Per Diode)				2.1	K/W

### NTC Characteristics ( $T_J = 25^\circ\text{C}$ , unless otherwise specified)

Symbol	Parameters	Test Conditions	Min	Typ	Max	Unit
$R_{25}$	Resistance	$T_c=25^\circ\text{C}$		5		K $\Omega$
$B_{25/50}$				3375		K

**Figure 1: Typical Output Characteristics for IGBT Inverter**

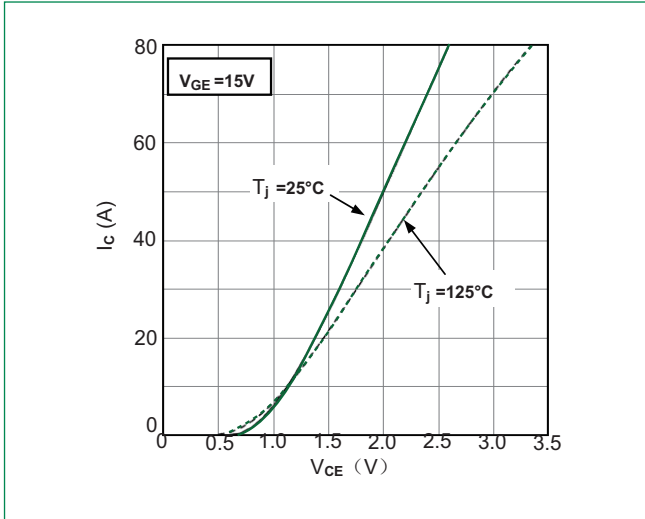

**Figure 2: Typical Output Characteristics for IGBT Inverter**

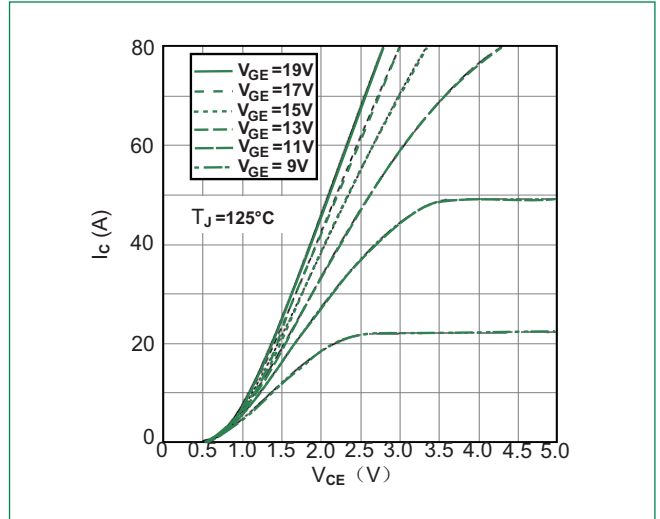

**Figure 3: Typical Transfer Characteristics for IGBT Inverter**

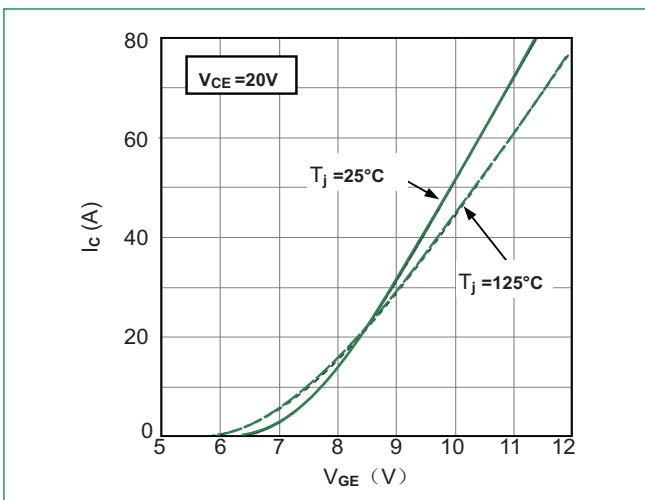

**Figure 4: Switching Energy vs. Gate Resistor for IGBT Inverter**

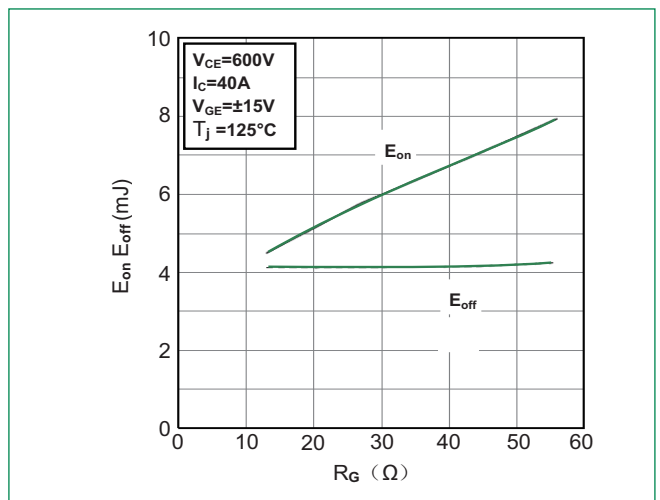

**Figure 5: Switching Energy vs. Collector Current for IGBT Inverter**

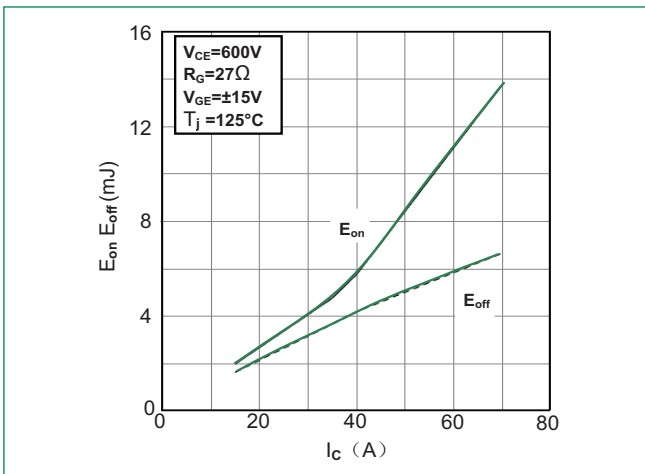

**Figure 6: Reverse Biased Safe Operating Area for IGBT Inverter**

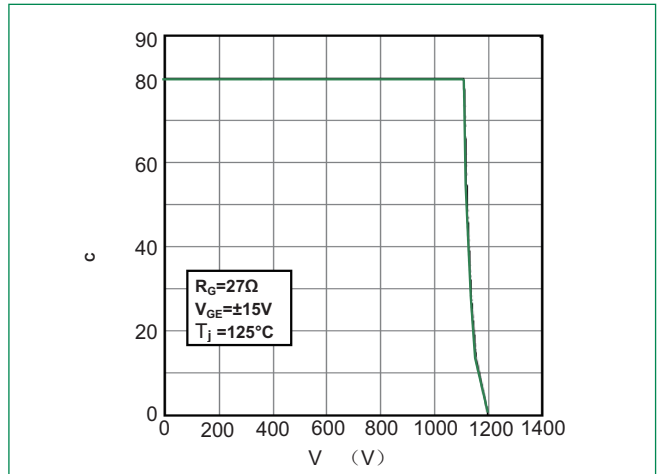

**Figure 7: Diode Forward Characteristics for Diode Inverter**

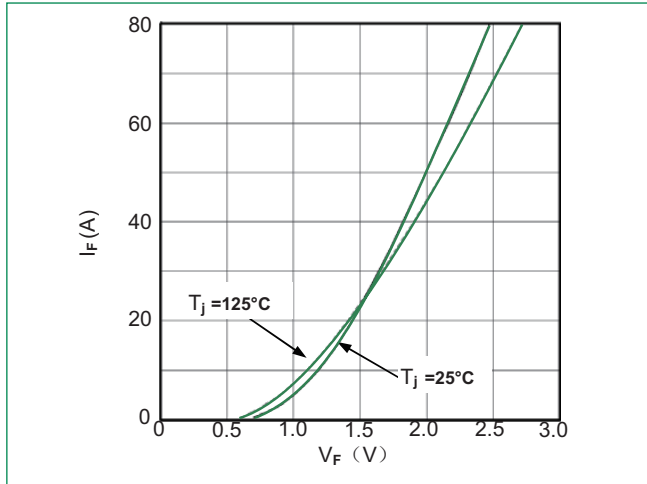

**Figure 8: Switching Energy vs. Gate Resistort for Diode Inverter**

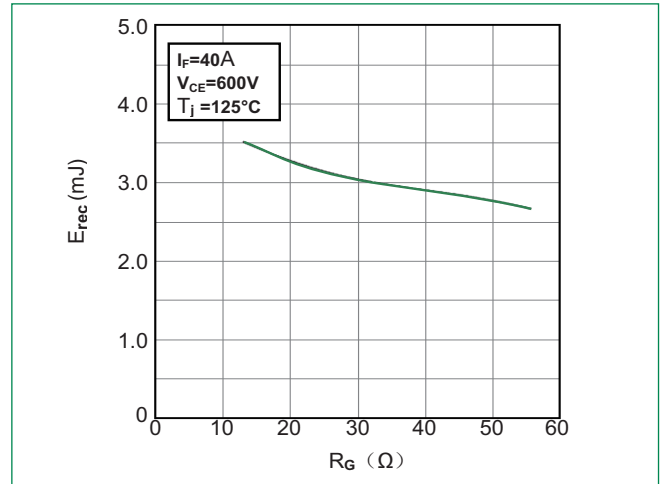

**Figure 9: Switching Energy vs. Forward Current Diode-inverter**

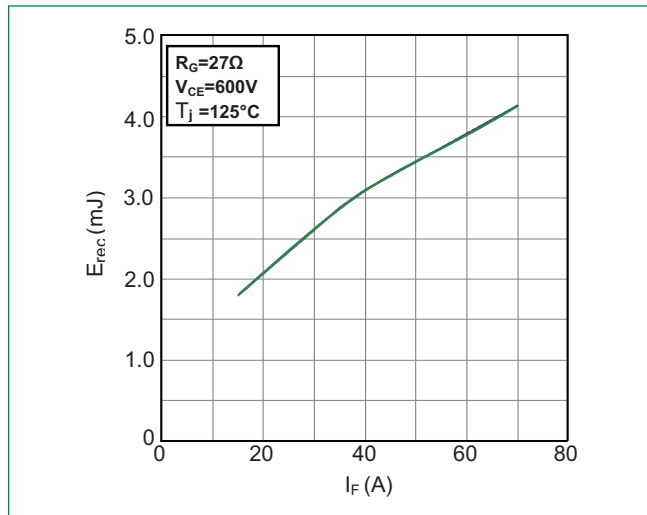

**Figure 10: Transient Thermal Impedance of Diode and IGBT-inverter**

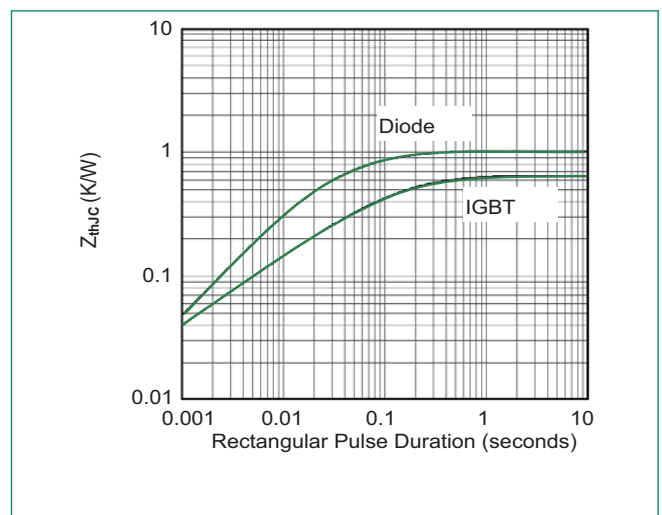

**Figure 11: Diode Forward Characteristics Diode- rectifier**

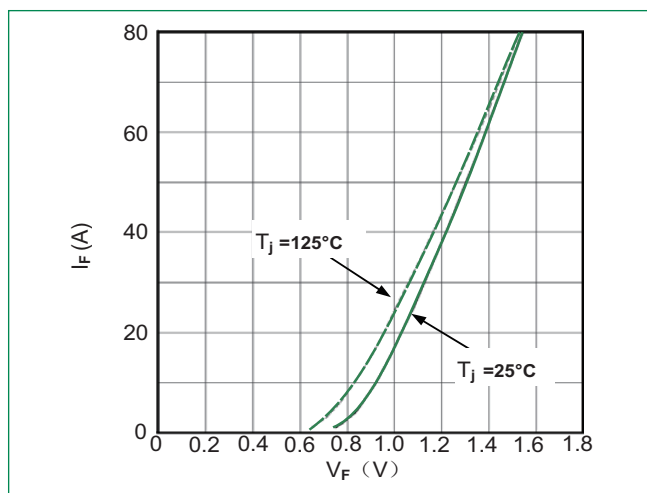

**Figure 12: Typical Output Characteristics IGBT- brake chopper**

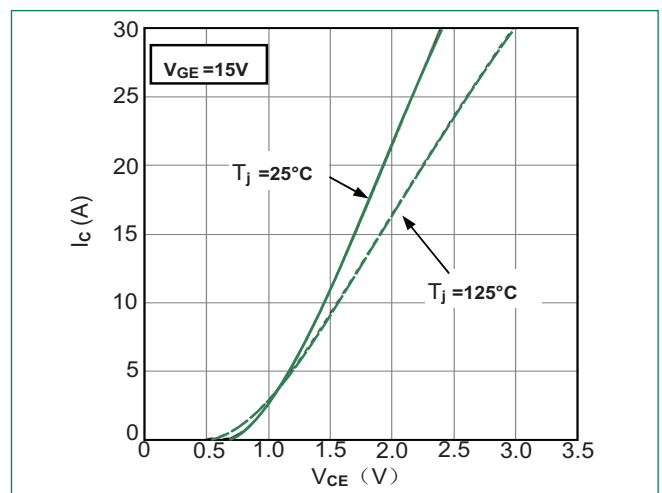

**Figure 13: Diode Forward Characteristics**  
 Diode - brake chopper

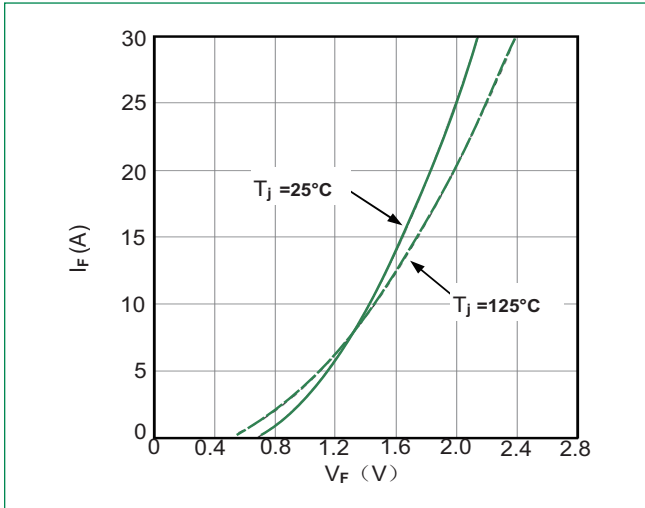

**Figure 14: NTC Characteristics**

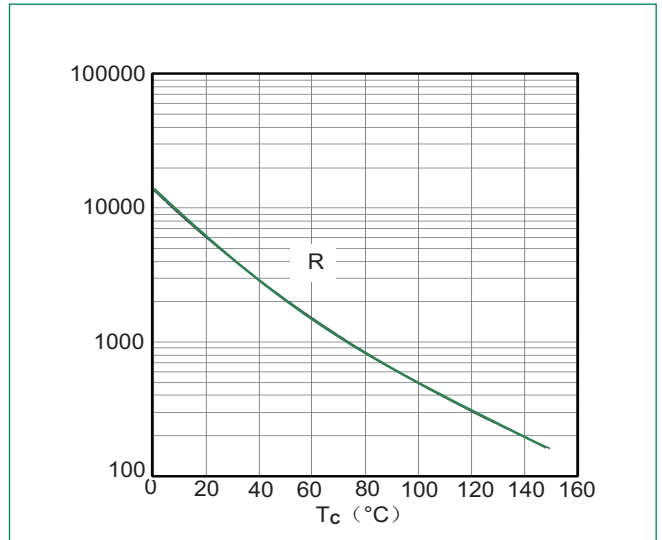

**Circuit Diagram**

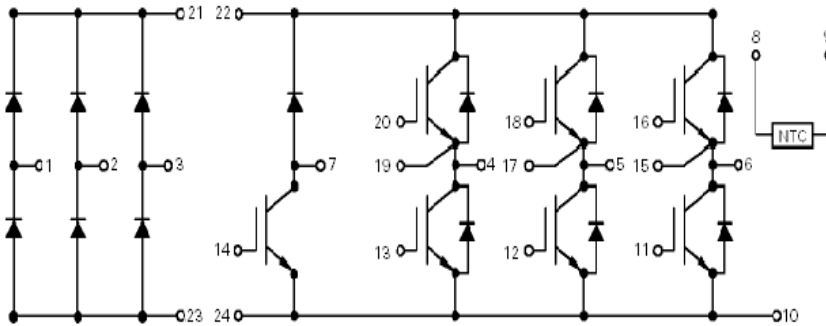

**Dimensions-Package H**

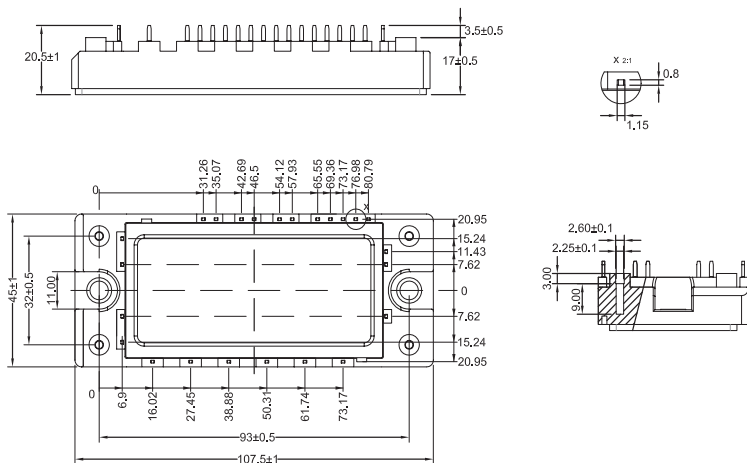

The foot pins are in gold / nickel coating

### Packing Options

Part Number	Marking	Weight	Packing Mode	M.O.Q
MG1240H-XBN2MM	MG1240H-XBN2MM	180g	Bulk Pack	40

### Part Numbering System

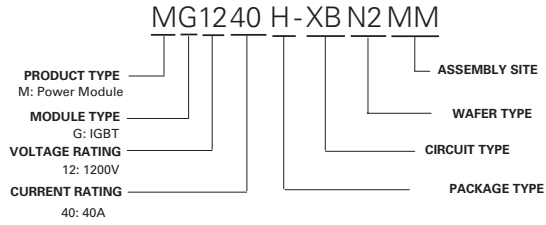

### Part Marking System

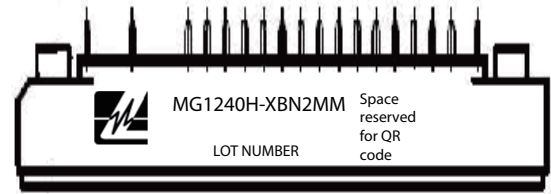



## X-ON Electronics

Largest Supplier of Electrical and Electronic Components

*Click to view similar products for [IGBT Modules category](#):*

*Click to view products by [Littelfuse manufacturer](#):*

Other Similar products are found below :

[F3L400R07ME4\\_B22](#) [F4-50R07W2H3\\_B51](#) [FB15R06W1E3](#) [FB20R06W1E3\\_B11](#) [FD1000R33HE3-K](#) [FD400R12KE3](#) [FD400R33KF2C-K](#)  
[FD401R17KF6C\\_B2](#) [FD-DF80R12W1H3\\_B52](#) [FF200R06YE3](#) [FF300R12KE4\\_E](#) [FF450R12ME4P](#) [FF600R12IP4V](#) [FP20R06W1E3](#)  
[FP50R12KT3](#) [FP75R07N2E4\\_B11](#) [FS10R12YE3](#) [FS150R07PE4](#) [FS150R12PT4](#) [FS200R12KT4R](#) [FS50R07N2E4\\_B11](#) [FZ1000R33HE3](#)  
[FZ1800R17KF4](#) [DD250S65K3](#) [DF1000R17IE4](#) [DF1000R17IE4D\\_B2](#) [DF1400R12IP4D](#) [DF200R12PT4\\_B6](#) [DF400R07PE4R\\_B6](#)  
[BSM75GB120DN2\\_E3223c-Se](#) [F3L300R12ME4\\_B22](#) [F3L75R07W2E3\\_B11](#) [F4-50R12KS4\\_B11](#) [F475R07W1H3B11ABOMA1](#)  
[FD1400R12IP4D](#) [FD200R12PT4\\_B6](#) [FD800R33KF2C-K](#) [FF1200R17KP4\\_B2](#) [FF150R12ME3G](#) [FF300R17KE3\\_S4](#) [FF300R17ME4\\_B11](#)  
[FF401R17KF6C\\_B2](#) [FF650R17IE4D\\_B2](#) [FF900R12IP4D](#) [FF900R12IP4DV](#) [STGIF7CH60TS-L](#) [FP50R07N2E4\\_B11](#) [FS100R07PE4](#)  
[FS150R07N3E4\\_B11](#) [FS150R17N3E4](#)