

MICRO2™ Blade Fuses - Aftermarket

Rated 32V

RoHS



Specifications

Voltage Rating:	32 VDC
Interrupting Rating:	1000A @ 32 VDC
*Recommended Environmental Temperature:	-40°C to +125°C
Terminals Material:	Silver plated / Tin plated zinc alloy
Housing Material:	PA66 (U.L. 94 Flammability rating – V2)
Net Weight Per Fuse:	0.53±5% gr
Complies with:	SAE 2741, ISO 8820-12:2020

*Tin plating's temperature limit is =130°C, Silver plating allows up to 150°C at the terminal interface.

Applications

- Cars
- Trucks
- SUVs
- Offroad vehicles
- Buses
- Watercraft as approved by Littelfuse®

Description

MICRO2™ blade fuses employ subminiature design, which allows them to provide more automotive circuit protection in less space. MICRO2 fuses have also passed performance tests proving their reliability in polluted, humid, and high-temperature environments.

Features & Benefits

- Color coding shows the amperage rating for each fuse
- See-through housing makes it easy to check whether a fuse has blown
- Checkpoints on top make it possible to measure resistance without removing the fuse
- High-contrast amperage stamp on the top of the housing aids identification
- Simple to install and remove







Ordering Information

COLOR CODE	CURRENT RATING (A)	BULK 4000 PC	BULK 500 PC	BULK 50 PC	BOXED 5 PC	CARDED 5 PC
		MATERIAL #	MATERIAL #	MATERIAL #	MATERIAL #	MATERIAL #
Tan	5A	0327005.ZXS	0327005.UXS	0327005.LXS	MIC2005.V	MIC2005.VP
Brown	7.5A	032707.5ZXS	032707.5UXS	032707.5LXS	MIC207.5V	MIC207.5VP
Red	10A	0327010.ZXS	0327010.UXS	0327010.LXS	MIC2010.V	MIC2010.VP
Blue	15A	0327015.ZXS	0327015.UXS	0327015.LXS	MIC2015.V	MIC2015.VP
Yellow	20A	0327020.ZXS	0327020.UXS	0327020.LXS	MIC2020.V	MIC2020.VP
Clear	25A	0327025.ZXS	0327025.UXS	0327025.LXS	MIC2025.V	MIC2025.VP
Green	30A	0327030.ZXS	0327030.UXS	0327030.LXS	MIC2030.V	MIC2030.VP

MICRO2™ Blade Fuses - Aftermarket

Rated 32V

Ratings

Part Numbers	Current Rating (A)	Housing Material Color	Test Cable Size (mm ²)	Typ. Voltage Drop (mV)	Typ. Cold Resistance (mΩ)	Typ. I ² t (A ² s)
0327005_ / MIC2005_	5		0.5	116	17.4	17
032707.5_ / MIC207.5_	7.5		0.75	106	10.8	47
0327010_ / MIC2010_	10		1	102	7.7	90
0327015_ / MIC2015_	15		1.5	94	4.9	190
0327020_ / MIC2020_	20		2.5	91	3.5	400
0327025_ / MIC2025_	25		2.5	90	2.6	580
0327030_ / MIC2030_	30		4	88	2.1	1,000

The typical I²t is an average value calculated from the breaking capacity tests by using the melting time before the arcing occurs.

Dimensions

Dimensions in mm for reference only.
See outline drawing for dimensions and tolerances.

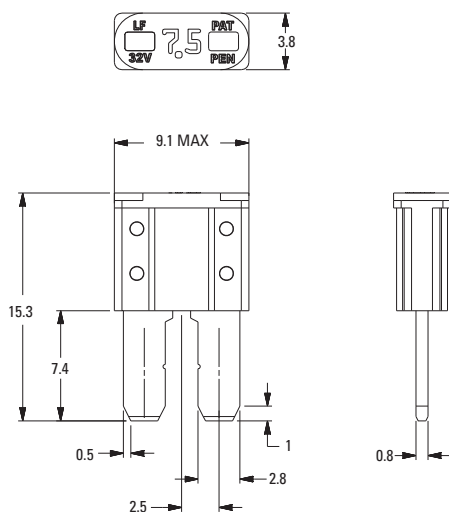

MICRO2™ Blade Fuses - Aftermarket

Rated 32V

Time-Current Characteristic Curves

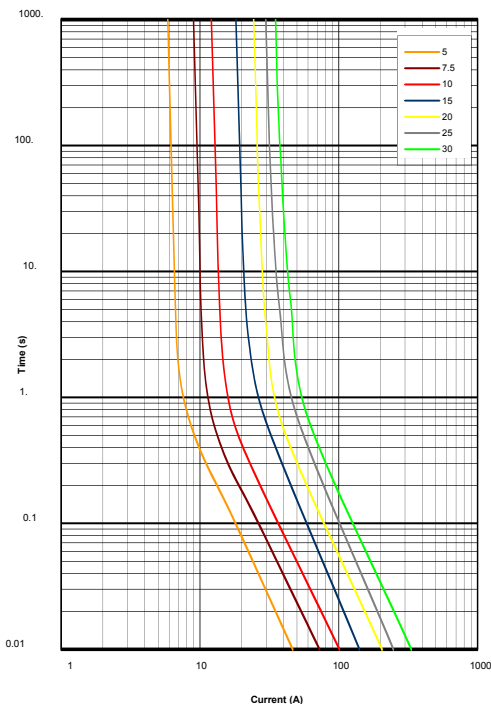

Time-Current Characteristics

% of Rating	Opening Time Min / Max (s)
110	360,000 / ∞
135	0.75 / 120
160	0.3 / 50
200	0.15 / 5
350	0.04 / 0.5
600	0.02 / 0.1

Typical Derating of Fuse Melting Element

Temperature Security Margin is 20%
 Wire Cross Section And Fixture Test Set Up Refer To ISO 8820-3
 Please Contact Littelfuse® For Details Regarding Derating Test Set Up

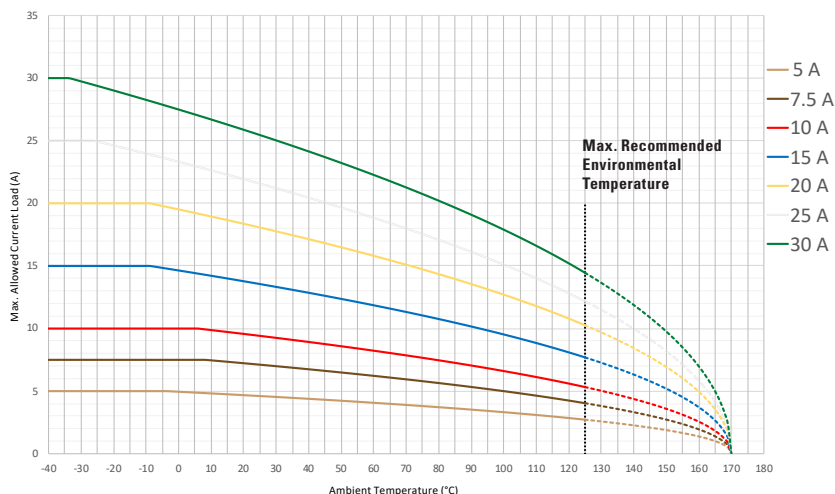

Derating curves may change depending on the final condition of the application (terminals characteristics, wire size etc.). Please ask Littelfuse® for more information.

Temperature Table

	max. allowed current load (A) at ambient temperature (typical derating)						
	-40°C	0°C	20°C	65°C	85°C	110°C	125°C
5 A	5	5	5	4	4	3	3
7.5 A	7.5	7.5	7	6	5	5	4
10 A	10	10	10	8	7	6	5
15 A	15	15	14	12	10	9	8
20 A	20	20	18	15	14	12	10
25 A	25	23	22	18	17	14	12
30 A	30	27	26	22	20	17	14

X-ON Electronics

Largest Supplier of Electrical and Electronic Components

Click to view similar products for [Automotive Fuses](#) category:

Click to view products by [Littelfuse](#) manufacturer:

Other Similar products are found below :

[ATM-4LP](#) [299080](#) [HBO-70](#) [0287015](#) [FMM-15](#) [0297003.WXT](#) [0695060.PXPS](#) [MRBF-075](#) [MRBF-300](#) [MRBF-200](#) [ANX80-UL-20A](#)
[ANX80-UL-25A](#) [ANX80-UL-30A](#) [ANX80-UL-35A](#) [ANX80-UL-40A](#) [ANT-I-3A](#) [APM-I-25A](#) [APR-10A](#) [APR-25A](#) [ANX58-UL-20A](#)
[ANX58-UL-25A](#) [ANX58-UL-35A](#) [ANX58-UL-40A](#) [ANX58-UL-50A](#) [ANM-4A](#) [ANM-25A](#) [ANE-175A](#) [APM-25A](#) [APM-4A](#) [ACB2-PL-](#)
[15A](#) [ACB2-PL-25A](#) [ANM58-15A](#) [ANM58-5A](#) [FMX-LP-20A](#) [MIDA-50A](#) [0695040.PXP](#) [0327030.YX2T](#) [0298500.UX1M8](#) [0299070.ZXT](#)
[20A32V](#) [ATM-1](#) [MRBF-040](#) [MRBF-100](#) [MRBF-250](#) [MRBF-050](#) [MRBF-060](#) [CFCOVER-2R](#) [MRBF-030](#) [3298600.ZXM10](#) [AMG-80](#)