

MICRO3™ Blade Fuses - Aftermarket

Rated 32V

RoHS



Specifications

Voltage Rating:	32 VDC
Interrupting Rating:	1000A @ 32 VDC
*Recommended Environmental Temperature:	-40°C to +125°C
Terminals Material:	Silver plated zinc alloy
Housing Material:	PA66 (U.L. 94 Flammability rating – V2)
Net Weight Per Fuse:	0.95±10% gr
Complies with:	SAE 2741 and ISO 8820-3 in reference to electrical, mechanical and environmental performance requirements

*Silver plating allows up to 150°C at the terminal interface.

Applications

- Cars
- Trucks
- SUVs
- Offroad vehicles
- Buses
- Watercraft as approved by Littelfuse®

Description

MICRO3™ automotive blade fuses feature three silver-plated blades and two fuse elements while also boasting subminiature design. This allows automakers to pack more circuit protection into less space. Despite their low weight, MICRO3™ fuses perform well in adverse environments and at extreme temperatures.

Features & Benefits

- Color coding shows the amperage rating for each fuse
- See-through housing makes it easy to check whether a fuse has blown
- Checkpoints on top make it possible to measure resistance without removing the fuse
- High-contrast amperage stamp on the top of the housing aids identification
- Simple to install and remove

Ordering Information





COLOR CODE	CURRENT RATING (A)	BULK 200	BULK 50 PC	BOXED 5 PC	CARDED 5 PC
		MATERIAL #	MATERIAL #	MATERIAL #	MATERIAL #
Tan	5A	0337005.PXS	0337005.LXS	MIC3005.V	MIC3005.VP
Brown	7.5A	033707.5PXS	033707.5LXS	MIC307.5V	MIC307.5VP
Red	10A	0337010.PXS	0337010.LXS	MIC3010.V	MIC3010.VP
Blue	15A	0337015.PXS	0337015.LXS	MIC3015.V	MIC3015.VP

Please refer to the Littelfuse Aftermarket catalog for packaging information.

MICRO3™ Blade Fuses - Aftermarket

Rated 32V

Ratings

Part Numbers	Current Rating (A)	Housing Material Color	Test Cable Size (mm ²)		Typ. Voltage Drop (mV)	Typ. Cold Resistance (mΩ)	Typ. I ² t (A ² s)
			Side Fuse Blades	Center Fuse Blades			
0337005_ / MIC3005_	5		0.5	1	116	17.4	17
033707.5_ / MIC307.5_	7.5		0.75	1.5	106	10.8	47
0337010_ / MIC3010_	10		1	2.5	102	7.8	89
0337015_ / MIC3015_	15		1.5	4	94	4.9	189

The typical I²t is an average value calculated from the breaking capacity tests by using the melting time before the arcing occurs.

Dimensions

Dimensions in mm for reference only.
See outline drawing for dimensions and tolerances.

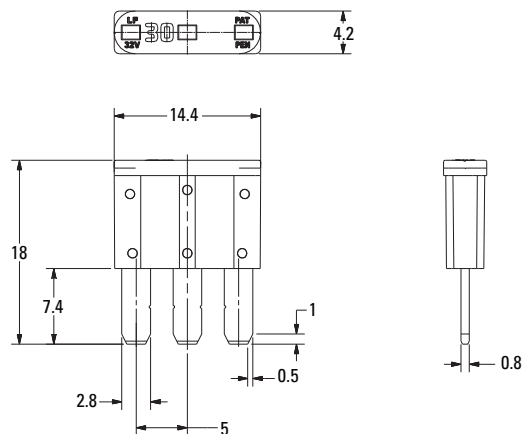

MICRO3™ Blade Fuses - Aftermarket

Rated 32V

Time-Current Characteristic Curves

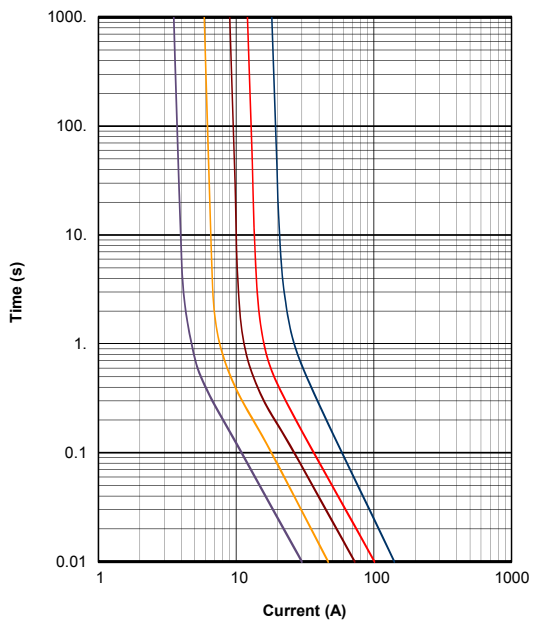

Time-Current Characteristics

% of Rating	Opening Time Min / Max (s)
110	360,000 / ∞
135	0.75 / 120
160	0.3 / 50
200	0.15 / 5
350	0.04 / 0.5
600	0.02 / 0.1

Typical Rerating Curve

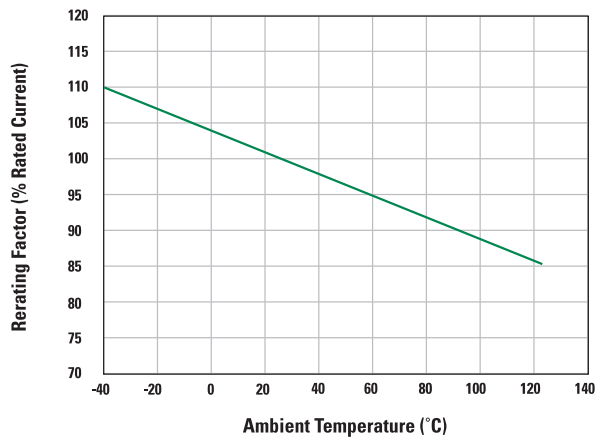

X-ON Electronics

Largest Supplier of Electrical and Electronic Components

Click to view similar products for [Automotive Fuses](#) category:

Click to view products by [Littelfuse](#) manufacturer:

Other Similar products are found below :

[ATM-4LP](#) [299080](#) [HBO-70](#) [0287015](#) [FMM-15](#) [0297003.WXT](#) [0695060.PXPS](#) [MRBF-075](#) [MRBF-300](#) [MRBF-200](#) [ANX80-UL-20A](#)
[ANX80-UL-25A](#) [ANX80-UL-30A](#) [ANX80-UL-35A](#) [ANX80-UL-40A](#) [ANT-I-3A](#) [APM-I-25A](#) [APR-10A](#) [APR-25A](#) [ANX58-UL-20A](#)
[ANX58-UL-25A](#) [ANX58-UL-35A](#) [ANX58-UL-40A](#) [ANX58-UL-50A](#) [ANM-4A](#) [ANM-25A](#) [ANE-175A](#) [APM-25A](#) [APM-4A](#) [ACB2-PL-](#)
[15A](#) [ACB2-PL-25A](#) [ANM58-15A](#) [ANM58-5A](#) [FMX-LP-20A](#) [MIDA-50A](#) [0695040.PXP](#) [0327030.YX2T](#) [0298500.UX1M8](#) [0299070.ZXT](#)
[20A32V](#) [ATM-1](#) [MRBF-040](#) [MRBF-100](#) [MRBF-250](#) [MRBF-050](#) [MRBF-060](#) [CFCOVER-2R](#) [MRBF-030](#) [3298600.ZXM10](#) [AMG-80](#)