

PLEDxUSWxA Series - Unidirectional, White Body



OBSOLETE DATE: 03/26/2020 PCN/ECN# 41325
REPLACED BY: PLEDxUSxA series



Description

PLEDxUSWxA open LED protectors provide a switching electronic shunt path when an LED in an electronic switching fails as an open circuit. This ensures that the remaining string of LEDs will continue to function if a single LED does not.

The device is designed to enable higher reliability in indoor LED lighting applications such as advertisement lighting and other applications. Additionally, it is molded from white material to make them less visible in the LED fixture and the white molding also reflects more light to improve overall light engine efficiency.

This series is compatible with one, two and three watt LEDs that have a nominal 3V forward characteristic and is available in an SMB, PLEDxUSWxA is available in SMB surface mount package. The DO-214AA (SMB) low profile package is ideal for dense board applications.

Agency Approvals

Agency	Agency File Number
	E133083

Schematic Symbol

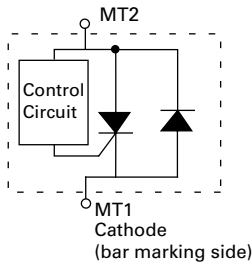

Features & Benefits

- Ideal for protecting high brightness LED with high operating current at specified condition.
- White compound for better optical appearances
- Fast switching
- Reverse Battery/Power Protection
- Low profile, small foot print standard DO-214AA package
- Compatible with industrial lighting environments
- IEC-61000-4-2 ESD 30kV (Air), 30kV (Contact)
- ESD protection of data lines in accordance with IEC 61000-4-2 (IEC801-2)
- Compatible with PWM frequencies up to 30 kHz
- RoHS compliant and halogen-free
- Pb-free E3 means 2nd level interconnect is Pb-free and the terminal finish material is tin(Sn) (IPC/ JEDEC J-STD-609A.01)

Electrical Characteristics (All parameters are measured at T=25°C unless otherwise noted)

Part Number	Marking	V_{BR} breakdown		V_{DRM} breakdown	I_H	I_S	$I_T @ V_T$	$V_T @ I_T = 1$ Amp	I_o^1	Critical rate of rise dV/dt
		Volts		Volts	mAmps	mAmps	Amps	Volts	Amps	
		Min	Max	Min	Min	Max	Max	Max	Max	
PLED6USW2A	PL62A	6	16	6	5	100	1.0	1.2	2	250V/μs
PLED6USW3A	PL63A	6	16	6	5	100	1.0	1.2	3	250V/μs
PLED9USW3A	PL93A	9	18	9	5	100	1.0	1.2	3	250V/μs

Notes:
1. I_o - Operation current tested @ aluminum boards, ambient temp 85C

Thermal Considerations

Package	Symbol	Parameter	Value	Unit
DO-214AA in White 	T_J	Operating Junction Temperature Range	-40 to +150	°C
	T_S	Storage Temperature Range	-65 to +150	°C
	$R_{\theta JA}$	Thermal Resistance: Junction to Ambient	DO-214AA: 90 ¹ DO-214AA: 40 ²	°C/W

Notes:

- 1) Standard FR-4 PCB with Copper Pads (Recommended Size)
- 2) Aluminum PCB
 - Thickness: 1.6mm
 - Grade: 1-2 W/mK Thermal Conductivity
 - Trace thickness: 2 oz
 - Insulation layer thickness: 215 um
 - Solder Pad Dimensions: 2.0mm x 2.8mm (Recommended Size)

V-I Characteristics



V_T vs. I_T



Normalized DC Holding Current vs. Case Temperature

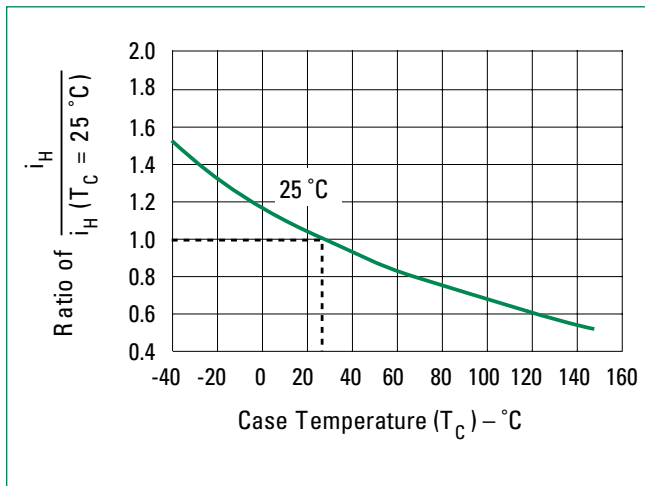

V_{BR} vs. Junction Temperature

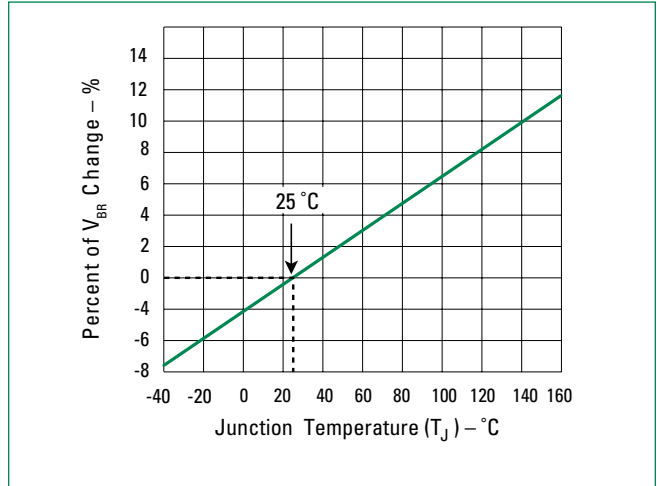

LED Interference Test Circuit



6 LEDs in Series 50% Duty Cycle 10kHz



5 LEDs and 1 PLED in Series 50% Duty Cycle 10kHz

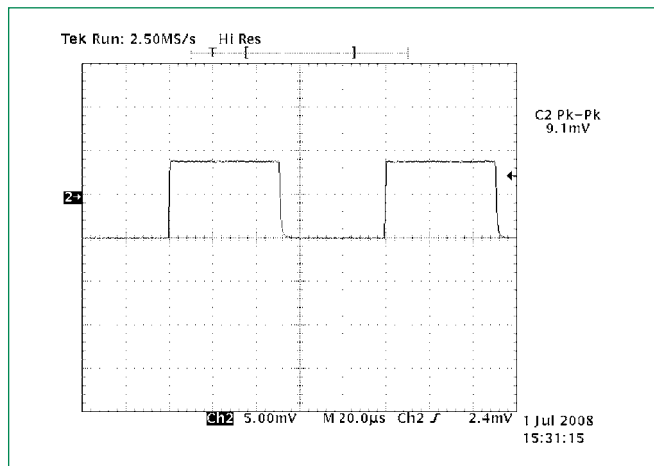

Note: These two graphs show the current magnitude through the LED string with and without the PLED included. There is no noticeable effect on the LED current magnitude when the PLED is included in the circuit as compared to the LED current magnitude when the PLED is not in the circuit. (The conversion factor for the test measurement in the graphs above is 10mA/mV for the Pearson coil measurement, therefore, the current magnitude in the first figure is 10mA*8.9 = 89mA, while the second figure is 91mA.)

PLED in the Off-State 10kHz



Channel 1: current through LEDs (318 mA)
Channel 2: voltage across PLED device (4.5 V)

PLED device zeners and then turns fully on 10kHz

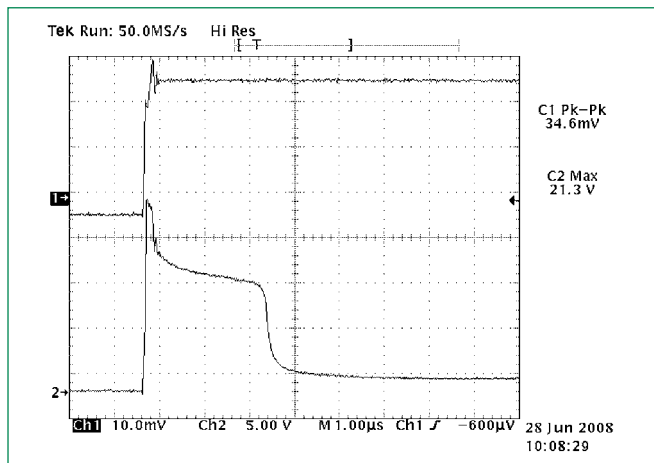

Channel 1: current through LEDs (346 mA) and PLED device once it is fully turned on 2.5 µsec later
Channel 2: voltage across PLED device (21.3 V before PLED crowbars with 2 V drop)

Soldering Parameters

Reflow Condition		Pb – Free assembly
Pre Heat	- Temperature Min ($T_{s(min)}$)	150°C
	- Temperature Max ($T_{s(max)}$)	200°C
	- Time (min to max) (t_s)	60 – 180 secs
Average ramp up rate (Liquidus Temp (T_L) to peak)		3°C/second max
$T_{s(max)}$ to T_L - Ramp-up Rate		3°C/second max
Reflow	- Temperature (T_L) (Liquidus)	217°C
	- Temperature (t_L)	60 – 150 seconds
Peak Temperature (T_p)		260 ^{+0/-5} °C
Time within 5°C of actual peak Temperature (t_p)		30 seconds
Ramp-down Rate		6°C/second max
Time 25°C to peak Temperature (T_p)		8 minutes max
Do not exceed		260°C

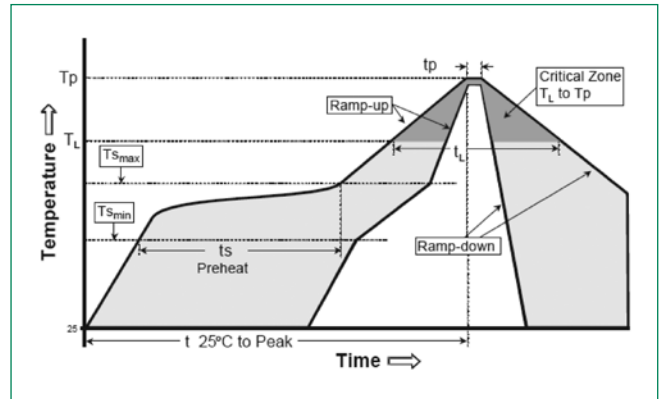

Physical Specifications

Terminal Material	Copper Alloy
Terminal Finish	100% Matte Tin Plated
Body Material	UL recognized compound meeting flammability classification V-0

Environmental Specifications

High Temperature Voltage Blocking	MIL-STD-750: Method 1040, Condition A 80% min V_{DRM} (VAC-peak), 150°C, 504 hours
Temperature Cycling	MIL-STD-750: Method 1051 -65°C to 150°C, 15-minute dwell, 100 cycles
Biased Temperature & Humidity	EIA/JEDEC: JESD22-A101 80% V_{DRM} , 85°C, 85% RH, 1008 hours
High Temperature Storage	MIL-STD-750: Method 1031 150°C, 1008 hours
Low Temperature Storage	-65°C, 1008 hours
Thermal Shock	MIL-STD-750: Method 1056 0°C to 100°C, 5-minute dwell, 10-second transfer, 10 cycles
Resistance to Solder Heat	MIL-STD-750: Method 2031 260°C, 10 seconds

Packaging

Package	Description	Packaging Quantity	Industry Standard
S	DO-214AA	2500	EIA-481-1

Part Numbering System



Part Marking System

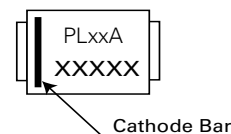

Dimensions - DO-214 AA Package

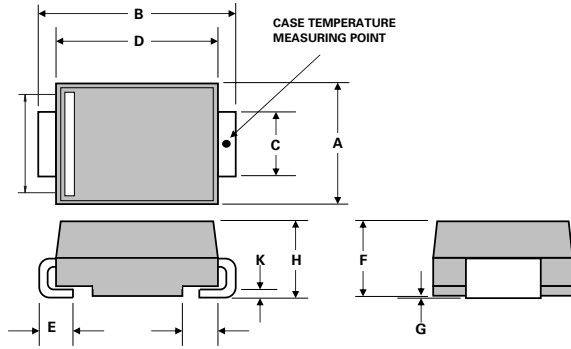

Dimensions	Inches		Millimeters	
	Min	Max	Min	Max
A	0.130	0.156	3.30	3.95
B	0.201	0.220	5.10	5.60
C	0.077	0.087	1.95	2.20
D	0.159	0.181	4.05	4.60
E	0.030	0.063	0.75	1.60
F	0.075	0.096	1.90	2.45
G	0.002	0.008	0.05	0.20
H	0.077	0.104	1.95	2.65
K	0.006	0.016	0.15	0.41

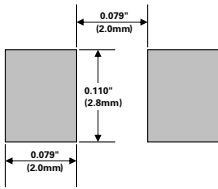

Recommended solder pad layout
(Reference Only)

DO-214AA Embossed Carrier Reel Pack (RP)

Meets all EIA-481-1 Standards

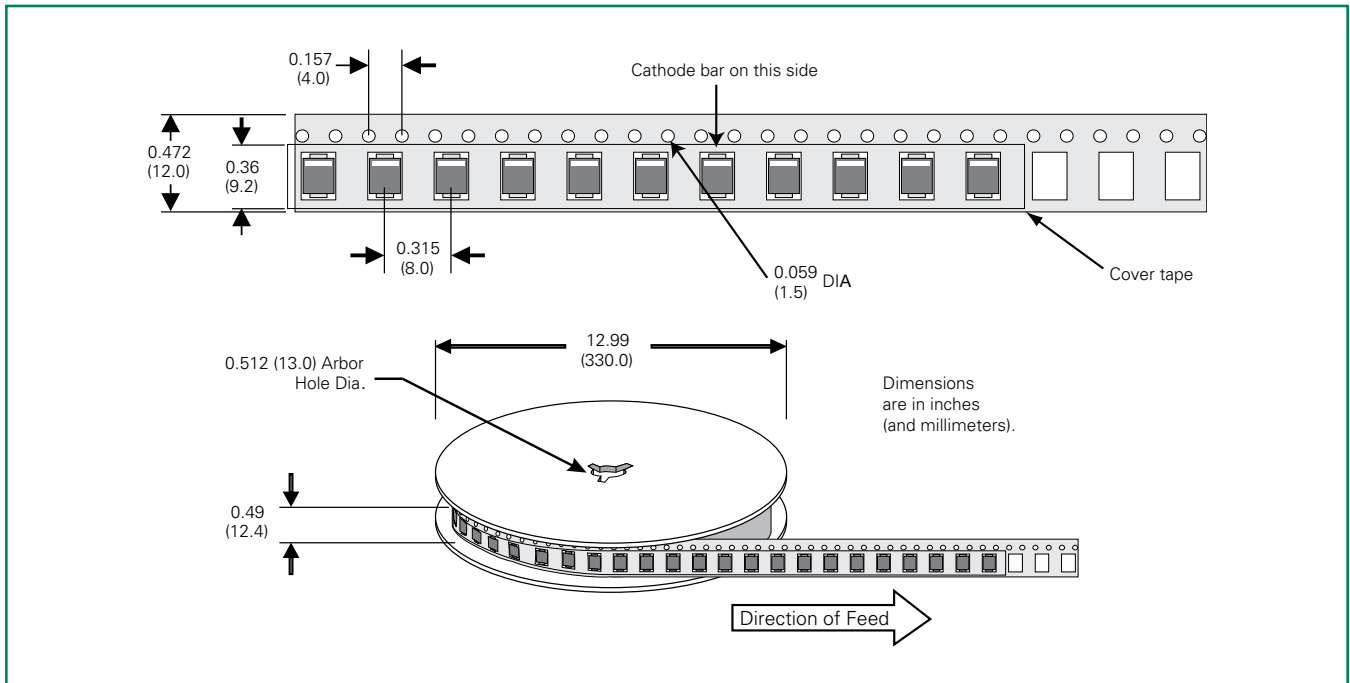

Disclaimer Notice - Information furnished is believed to be accurate and reliable. However, users should independently evaluate the suitability of and test each product selected for their own applications. Littelfuse products are not designed for, and may not be used in, all applications. Read complete Disclaimer Notice at <http://www.littelfuse.com/disclaimer-electronics>.

X-ON Electronics

Largest Supplier of Electrical and Electronic Components

Click to view similar products for [LED Protection Devices](#) category:

Click to view products by [Littelfuse](#) manufacturer:

Other Similar products are found below :

[HBL1025T1G](#) [SZHBL5006XV2T1G](#) [NUD4700WSNT1G](#) [SZHBL5006HT1G](#) [LSP10480LLS](#) [LSP10240SX3333](#) [LSP05GI240P](#) [D-1](#)
[LSP0600AJR-S](#) [LSP0600BJR-S](#) [LSP0900AJR-S](#) [LSP0900BJR-S](#) [LSP1300AJR-S](#) [LSP1300BJR-S](#) [LSP1800AJR-S](#) [LSP1800BJR-S](#)
[LSP05120P](#) [LSP05480LLP](#) [LSP05G240PX3316](#) [LSP05G240PX3333](#) [LSP05G240S](#) [LSP05G240SX3316](#) [LSP05G240SX3333](#) [LSP05G277P](#)
[LSP05G277PX3316](#) [LSP05G277PX3333](#) [LSP05G277S](#) [LSP05GI240S](#) [LSP05GI277P](#) [LSP05GI120S](#) [LSP05GI277PHX3333](#) [LSP05GI277S](#)
[LSP10120P](#) [LSP10120S](#) [LSP10240LLP](#) [LSP10240S](#) [LSP10277SX3316](#) [LSP10480LLP](#) [LSP05277PX3333](#) [LSP05G240P](#) [LSP10GIHP277S](#)
[PLED9Q12](#) [PLED13Q12](#) [PLED13S](#) [PLED13UQ12](#) [PLED13US](#) [PLED150S](#) [PLED180S](#) [PLED18Q12](#) [PLED18S](#)