

POWR-SPEED® Fuse

PSR SERIES HIGH-SPEED SQUARE BODY

Semiconductor Fuses • DIN 43653 Blade • 40 A–2250 A



Description

Littelfuse PSR series high-speed square body fuses are specially designed for protection of power semiconductor devices such as diodes, triacs, IGBTs, SCRs, MOSFETs, and other solid-state devices that are typically designed into power conversion and power conditioning equipment. Variable frequency drives, inverters, UPS, rectifiers, and soft-starters are examples of typical equipment designed with sensitive power semiconductor devices that cannot withstand any line surge or overcurrent conditions and require high-speed protection.

Littelfuse POWR-SPEED® PSR series products offer optimized circuit protection at the extremely fast speed required to protect modern day power conversion devices. Available in DIN43653 blade style termination with visual blown fuse indication standard on all fuses and optional micro-switch for external indication.

Features/Benefits

- Best in class dc performance
- Extremely current limiting
- Superior cycling capability
- Global certification cURus, CCC*, IEC
- Visual and optional microswitch fuse blown indication
- Low watt-loss design
- Compliance with US and Canadian requirements
- Fast-acting Class aR performance

Applications

- Power conversion devices (UPS, inverter, rectifiers, drives)
- Dc systems (dc common bus, dc injection braking)
- Battery protection application (energy storage systems)
- Electric vehicle charging stations
- Heaters and power supplies

* Refer to CCC section of Electrical Characteristics table

Specifications

Voltage Rating	Ac: 450 V–1300 V Dc: 450 V–1000 V
Amperage Rating	40 A–2250 A
Interrupting Rating	Ac: 100 kA–200 kA Dc: 150 kA
Time Constant	10 ms at IR
Microswitch	Yes
Mounting	DIN 43653 blade style
Material	Body: ceramic Contacts: plated copper
Approvals	cURus Recognized (File: E71611) CCC (Ac voltage) *
Applicable Standards	UL248-13, IEC 60269-4 (Class aR)
Environmental	RoHS Compliant, REACH
Operating Temperature	-55 °C to +125 °C
Storage Temperature	Up to +35 °C with relative humidity <65 %
Country of Origin	Mexico

Ordering Part Number

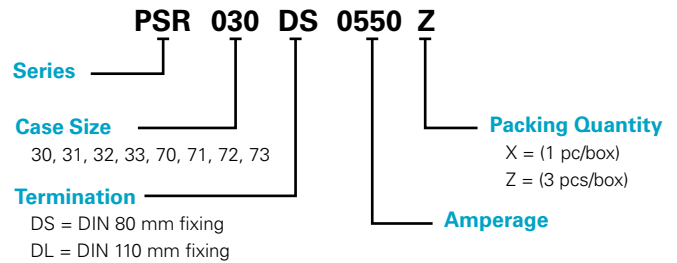

Catalog Number

SERIES	CASE SIZE	TERMINATION	AMPERAGE	CATALOG NUMBER	ORDERING PART NUMBER
PSR	030	DS	0550	PSR030DS0550	PSR030DS0550Z

Recommended Accessories

Microswitch: MS3H1000C (Case Size 30 to 33)
MS7H1500C (Case Size 70 to 73)

Web Resources

Download technical documents: [Littelfuse.com/PSR](https://www.littelfuse.com/PSR)
Note: high-speed fuses are designed for fixed installations. They are not intended for use in moving vehicle applications.

POWR-SPEED® Fuse

PSR SERIES HIGH-SPEED SQUARE BODY

Electrical Characteristics

CASE SIZE	CATALOG NUMBER		AMPERE RATING (A)	VOLTAGE RATING (V)			INTERRUPTING RATING		MELTING (PRE-ARC) I ² T (A ² S)	TOTAL CLEARING I ² T (A ² S) AT RATED VOLTAGE		WATT LOSS AT 100 % RATED CURRENT (W)	AGENCY CERTIFICATION	
	DIN 80 MM FIXING (DS)	DIN 110 MM FIXING (DL)		AC		DC	AC	DC		AC	DC		cURus	CCC
				IEC	UL									
30	PSR030DS0040	PSR030DL0040	40	690	700	600	200 kA	150 kA	76	280	260	13	•	•
	PSR030DS0050	PSR030DL0050	50	690	700	600	200 kA	150 kA	110	598	384	16	•	•
	PSR030DS0063	PSR030DL0063	63	690	700	600	200 kA	150 kA	176	1023	640	20	•	•
	PSR030DS0080	PSR030DL0080	80	690	700	600	200 kA	150 kA	304	1728	1252	24	•	•
	PSR030DS0100	PSR030DL0100	100	690	700	600	200 kA	150 kA	437	2835	1575	28	•	•
	PSR030DS0125	PSR030DL0125	125	690	700	600	200 kA	150 kA	707	4684	2783	37	•	•
	PSR030DS0160	PSR030DL0160	160	690	700	600	200 kA	150 kA	1359	9114	5507	40	•	•
	PSR030DS0200	PSR030DL0200	200	690	700	600	200 kA	150 kA	3012	15169	14700	40	•	•
	PSR030DS0250	PSR030DL0250	250	690	700	600	200 kA	150 kA	4668	29952	20833	52	•	•
	PSR030DS0315	PSR030DL0315	315	690	700	600	200 kA	150 kA	7131	61830	31600	64	•	•
	PSR030DS0350	PSR030DL0350	350	690	700	600	200 kA	150 kA	12007	85320	49273	66	•	•
	PSR030DS0400	PSR030DL0400	400	690	700	600	200 kA	150 kA	16209	114750	63367	78	•	•
	PSR030DS0450	PSR030DL0450	450	690	700	600	200 kA	150 kA	23133	160110	93533	80	•	•
	PSR030DS0500	PSR030DL0500	500	690	700	600	200 kA	150 kA	31429	225180	137333	84	•	•
PSR030DS0550	PSR030DL0550	550	690	700	600	200 kA	150 kA	44323	268920	145400	85	•	•	
PSR030DS0630	PSR030DL0630	630	690	700	550	200 kA	150 kA	57404	480010	267800	91	•	•	
31	PSR031DS0200	PSR031DL0200	200	690	700	600	200 kA	150 kA	1965	17334	16188	49	•	•
	PSR031DS0250	PSR031DL0250	250	690	700	600	200 kA	150 kA	3789	35343	21080	52	•	•
	PSR031DS0315	PSR031DL0315	315	690	700	600	200 kA	150 kA	6862	59130	30694	63	•	•
	PSR031DS0350	PSR031DL0350	350	690	700	600	200 kA	150 kA	9523	76140	40996	67	•	•
	PSR031DS0400	PSR031DL0400	400	690	700	600	200 kA	150 kA	14770	124335	64359	70	•	•
	PSR031DS0450	PSR031DL0450	450	690	700	600	200 kA	150 kA	22457	178200	97444	70	•	•
	PSR031DS0500	PSR031DL0500	500	690	700	600	200 kA	150 kA	29751	251505	125935	74	•	•
	PSR031DS0550	PSR031DL0550	550	690	700	600	200 kA	150 kA	42056	289170	171845	86	•	•
	PSR031DS0630	PSR031DL0630	630	690	700	600	200 kA	150 kA	73513	507465	276315	87	•	•
	PSR031DS0700	PSR031DL0700	700	690	700	600	200 kA	150 kA	98187	601425	337260	93	•	•
PSR031DS0800	PSR031DL0800	800	690	700	600	200 kA	150 kA	137208	848880	502815	107	•	•	
PSR031DS0900	PSR031DL0900	900	550	600	550	200 kA	150 kA	155163	945100	631820	126	•	•	
32	PSR032DS0400	PSR032DL0400	400	690	700	600	200 kA	150 kA	11104	79650	44533	87	•	•
	PSR032DS0450	PSR032DL0450	450	690	700	600	200 kA	150 kA	15535	116100	65463	88	•	•
	PSR032DS0500	PSR032DL0500	500	690	700	600	200 kA	150 kA	21573	161460	88277	94	•	•
	PSR032DS0550	PSR032DL0550	550	690	700	600	200 kA	150 kA	26327	177660	107960	106	•	•
	PSR032DS0630	PSR032DL0630	630	690	700	600	200 kA	150 kA	34790	234900	156963	114	•	•
	PSR032DS0700	PSR032DL0700	700	690	700	600	200 kA	150 kA	51191	291870	209287	127	•	•
	PSR032DS0800	PSR032DL0800	800	690	700	600	200 kA	150 kA	60125	472770	249000	152	•	•
	PSR032DS0900	PSR032DL0900	900	690	700	600	200 kA	150 kA	107785	764100	404000	145	•	•
	PSR032DS1000	PSR032DL1000	1000	690	700	600	200 kA	150 kA	190102	933120	672333	149	•	•
	PSR032DS1100	PSR032DL1100	1100	690	700	600	200 kA	150 kA	225379	1247400	744000	161	•	•
	PSR032DS1250	PSR032DL1250	1250	550	500*	450*	200 kA	150 kA	336661	1114994	1197000	166	•	•
	PSR032DS1400	PSR032DL1400	1400	450	500	450	200 kA	150 kA	551749	1611639	1865400	184	•	•
	PSR032DS1500	PSR032DL1500	1500	450	500	450	200 kA	150 kA	673360	2045907	1735500	192	•	•
33	PSR033DS0450	PSR033DL0450	450	690	700	600	200 kA	150 kA	13600	106380	58947	107	•	•
	PSR033DS0500	PSR033DL0500	500	690	700	600	200 kA	150 kA	16434	140400	77846	107	•	•
	PSR033DS0550	PSR033DL0550	550	690	700	600	200 kA	150 kA	23314	187650	100461	111	•	•
	PSR033DS0630	PSR033DL0630	630	690	700	600	200 kA	150 kA	38727	285930	142437	120	•	•
	PSR033DS0700	PSR033DL0700	700	690	700	600	200 kA	150 kA	56763	392580	209863	116	•	•
	PSR033DS0800	PSR033DL0800	800	690	700	600	200 kA	150 kA	84691	575505	348500	122	•	•
	PSR033DS0900	PSR033DL0900	900	690	700	600	200 kA	150 kA	122619	740340	451177	138	•	•
	PSR033DS1000	PSR033DL1000	1000	690	700	600	200 kA	150 kA	222350	1170450	787750	138	•	•
	PSR033DS1100	PSR033DL1100	1100	690	700	600	200 kA	150 kA	310824	1568700	821400	138	•	•
	PSR033DS1250	PSR033DL1250	1250	690	700	500	200 kA	150 kA	476902	2403000	1674333	145	•	•
	PSR033DS1400	PSR033DL1400	1400	690	700	500	200 kA	150 kA	583552	2920050	1979750	173	•	•
	PSR033DS1500	PSR033DL1500	1500	600	650	500	200 kA	150 kA	674538	2433200	1996733	182	•	•
	PSR033DS1600	PSR033DL1600	1600	600	650	500	200 kA	150 kA	779948	2942800	2301633	208	•	•
	PSR033DS1800	PSR033DL1800	1800	600	650	500	200 kA	150 kA	952196	3785040	2724180	260	•	•
	PSR033DS2000	PSR033DL2000	2000	550	600	480	200 kA	150 kA	1234315	4131600	3755180	264	•	•
PSR033DS2250	PSR033DL2250	2250	500	550	450	200 kA	150 kA	1236000	4459651	3859500	349	•	•	

* PSR032 1250 A: 600 V Ac/550 V Dc

POWR-SPEED® Fuse

PSR SERIES HIGH-SPEED SQUARE BODY

Electrical Characteristics (cont.)

CASE SIZE	CATALOG NUMBER	AMPERE RATING (A)	VOLTAGE RATING (V)			INTERRUPTING RATING		MELTING (PRE-ARC) I ² T (A ² S)	TOTAL CLEARING I ² T (A ² S) AT RATED VOLTAGE		WATT LOSS AT 100 % RATED CURRENT (W)	AGENCY CERTIFICATION	
			AC		DC	AC	DC		AC	DC		cURus	CCC
	IEC		UL	IEC									
70	PSR070DL0050	50	1250	1300	1000	100 kA	150 kA	177	2050	400	21	•	•
	PSR070DL0063	63	1250	1300	1000	100 kA	150 kA	273	3399	900	24	•	•
	PSR070DL0080	80	1250	1300	1000	100 kA	150 kA	583	6732	2200	25	•	•
	PSR070DL0100	100	1250	1300	1000	100 kA	150 kA	974	10996	3750	30	•	•
	PSR070DL0125	125	1250	1300	1000	100 kA	150 kA	1352	13011	5150	44	•	•
	PSR070DL0160	160	1250	1300	1000	100 kA	150 kA	2377	25662	8950	53	•	•
	PSR070DL0200	200	1250	1300	1000	100 kA	150 kA	4177	39087	17267	62	•	•
	PSR070DL0250	250	1250	1300	1000	100 kA	150 kA	8629	89790	36750	73	•	•
	PSR070DL0280	280	1250	1300	1000	100 kA	150 kA	11844	113201	46750	77	•	•
PSR070DL0315	315	1250	1300	1000	100 kA	150 kA	18162	142051	66833	80	•	•	
PSR070DL0350	350	1250	1200*	900*	100 kA	150 kA	22963	215230	95410	76	•	•	
PSR070DL0400	400	1100	1200	900	100 kA	150 kA	37103	283480	154320	78	•	•	
71	PSR071DL0160	160	1250	1300	1000	100 kA	150 kA	2756	24600	8800	45	•	•
	PSR071DL0200	200	1250	1300	1000	100 kA	150 kA	4918	50307	19050	52	•	•
	PSR071DL0250	250	1250	1300	1000	100 kA	150 kA	10592	104427	43100	55	•	•
	PSR071DL0280	280	1250	1300	1000	100 kA	150 kA	13763	131897	54150	58	•	•
	PSR071DL0315	315	1250	1300	1000	100 kA	150 kA	20882	200244	67450	59	•	•
	PSR071DL0350	350	1250	1300	1000	100 kA	150 kA	23301	225500	102500	70	•	•
	PSR071DL0400	400	1250	1300	1000	100 kA	150 kA	43211	374986	185000	76	•	•
	PSR071DL0450	450	1250	1300	1000	100 kA	150 kA	55915	452394	241333	88	•	•
PSR071DL0500	500	1100	1200	900	100 kA	150 kA	75315	468845	253960	93	•	•	
PSR071DL0550	550	1100	1200	900	100 kA	150 kA	87328	693507	332600	90	•	•	
PSR071DL0630	630	1000	1100	900	100 kA	150 kA	131240	790862	426550	103	•	•	
72	PSR072DL0250	250	1250	1300	1000	100 kA	150 kA	7737	72789	28567	64	•	•
	PSR072DL0280	280	1250	1300	1000	100 kA	150 kA	10915	124538	46897	62	•	•
	PSR072DL0315	315	1250	1300	1000	100 kA	150 kA	16187	145140	58867	69	•	•
	PSR072DL0350	350	1250	1300	1000	100 kA	150 kA	18727	160447	69633	81	•	•
	PSR072DL0400	400	1250	1300	1000	100 kA	150 kA	27112	243540	108000	93	•	•
	PSR072DL0450	450	1250	1300	1000	100 kA	150 kA	35927	406413	159133	107	•	•
	PSR072DL0500	500	1250	1300	1000	100 kA	150 kA	50398	425375	216333	115	•	•
	PSR072DL0550	550	1250	1300	1000	100 kA	150 kA	73858	539833	271333	115	•	•
	PSR072DL0630	630	1250	1300	1000	100 kA	150 kA	126126	942180	436000	119	•	•
	PSR072DL0700	700	1100	1200	900**	100 kA	150 kA	228761	1123694	715180	89	•	•
	PSR072DL0800	800	1100	1200	900**	100 kA	150 kA	230695	1432388	911650	129	•	•
PSR072DL0900	900	1000	900*	900**	100 kA	150 kA	376641	1309993	1030400	131	•	•	
PSR072DL1000	1000	850	900	800**	100 kA	150 kA	455955	1772548	1361500	156	•	•	
73	PSR073DL0315	315	1250	1300	1000	100 kA	150 kA	10245	106600	38650	100	•	•
	PSR073DL0350	350	1250	1300	1000	100 kA	150 kA	13586	159627	57467	100	•	•
	PSR073DL0400	400	1250	1300	1000	100 kA	150 kA	19797	211273	86800	124	•	•
	PSR073DL0450	450	1250	1300	1000	100 kA	150 kA	29834	279073	114333	122	•	•
	PSR073DL0500	500	1250	1300	1000	100 kA	150 kA	42751	416437	184500	121	•	•
	PSR073DL0550	550	1250	1300	1000	100 kA	150 kA	55513	491713	224500	130	•	•
	PSR073DL0630	630	1250	1300	1000	100 kA	150 kA	94649	804338	377500	136	•	•
	PSR073DL0700	700	1250	1300	1000	100 kA	150 kA	158097	1170960	575667	135	•	•
	PSR073DL0800	800	1250	1300	1000**	100 kA	150 kA	234943	1769880	733460	128	•	•
	PSR073DL0900	900	950	1050	800**	100 kA	150 kA	317743	2280547	901779	156	•	•
	PSR073DL1000	1000	950	1050	800**	100 kA	150 kA	476221	3910801	1546418	143	•	•
	PSR073DL1100	1100	950	1050	800**	100 kA	150 kA	570870	2736600	1699000	165	•	•
	PSR073DL1250	1250	900	1000	-	100 kA	-	993924	3091160	-	197	•	•
PSR073DL1400	1400	900	1000	-	100 kA	-	1168091	3627820	-	249	•	•	

* PSR070 350 A: 1300 V Ac/1000 V Dc

PSR072 900 A: 1100 V Ac

** No UL certification for Dc voltage

POWR-SPEED® Fuse

PSR SERIES HIGH-SPEED SQUARE BODY

Ordering Information

CASE SIZE	DIN 80 MM FIXING (DS)			DIN 110 MM FIXING (DL)			BOX QUANTITY
	CATALOG NUMBER	ORDERING PART NUMBER	UPC	CATALOG NUMBER	ORDERING PART NUMBER	UPC	
30	PSR030DS0040	PSR030DS0040Z	07945824985	PSR030DL0040	PSR030DL0040Z	07945825049	3 pcs/box
	PSR030DS0050	PSR030DS0050Z	07945824986	PSR030DL0050	PSR030DL0050Z	07945825050	3 pcs/box
	PSR030DS0063	PSR030DS0063Z	07945824987	PSR030DL0063	PSR030DL0063Z	07945825051	3 pcs/box
	PSR030DS0080	PSR030DS0080Z	07945824988	PSR030DL0080	PSR030DL0080Z	07945825052	3 pcs/box
	PSR030DS0100	PSR030DS0100Z	07945824989	PSR030DL0100	PSR030DL0100Z	07945825054	3 pcs/box
	PSR030DS0125	PSR030DS0125Z	07945824990	PSR030DL0125	PSR030DL0125Z	07945825056	3 pcs/box
	PSR030DS0160	PSR030DS0160Z	07945824991	PSR030DL0160	PSR030DL0160Z	07945825057	3 pcs/box
	PSR030DS0200	PSR030DS0200Z	07945824992	PSR030DL0200	PSR030DL0200Z	07945825059	3 pcs/box
	PSR030DS0250	PSR030DS0250Z	07945824993	PSR030DL0250	PSR030DL0250Z	07945825060	3 pcs/box
	PSR030DS0315	PSR030DS0315Z	07945824994	PSR030DL0315	PSR030DL0315Z	07945825062	3 pcs/box
	PSR030DS0350	PSR030DS0350Z	07945824995	PSR030DL0350	PSR030DL0350Z	07945825066	3 pcs/box
	PSR030DS0400	PSR030DS0400Z	07945824996	PSR030DL0400	PSR030DL0400Z	07945825069	3 pcs/box
	PSR030DS0450	PSR030DS0450Z	07945824997	PSR030DL0450	PSR030DL0450Z	07945825070	3 pcs/box
	PSR030DS0500	PSR030DS0500Z	07945824998	PSR030DL0500	PSR030DL0500Z	07945825074	3 pcs/box
PSR030DS0550	PSR030DS0550Z	07945824999	PSR030DL0550	PSR030DL0550Z	07945825075	3 pcs/box	
PSR030DS0630	PSR030DS0630Z	07945827822	PSR030DL0630	PSR030DL0630Z	07945827801	3 pcs/box	
31	PSR031DS0200	PSR031DS0200Z	07945825000	PSR031DL0200	PSR031DL0200Z	07945825076	3 pcs/box
	PSR031DS0250	PSR031DS0250Z	07945825001	PSR031DL0250	PSR031DL0250Z	07945825077	3 pcs/box
	PSR031DS0315	PSR031DS0315Z	07945825002	PSR031DL0315	PSR031DL0315Z	07945825078	3 pcs/box
	PSR031DS0350	PSR031DS0350Z	07945825003	PSR031DL0350	PSR031DL0350Z	07945825079	3 pcs/box
	PSR031DS0400	PSR031DS0400Z	07945825004	PSR031DL0400	PSR031DL0400Z	07945825080	3 pcs/box
	PSR031DS0450	PSR031DS0450Z	07945825005	PSR031DL0450	PSR031DL0450Z	07945825081	3 pcs/box
	PSR031DS0500	PSR031DS0500Z	07945825006	PSR031DL0500	PSR031DL0500Z	07945825082	3 pcs/box
	PSR031DS0550	PSR031DS0550Z	07945825007	PSR031DL0550	PSR031DL0550Z	07945825083	3 pcs/box
	PSR031DS0630	PSR031DS0630Z	07945825008	PSR031DL0630	PSR031DL0630Z	07945825084	3 pcs/box
	PSR031DS0700	PSR031DS0700Z	07945825009	PSR031DL0700	PSR031DL0700Z	07945825085	3 pcs/box
PSR031DS0800	PSR031DS0800Z	07945825010	PSR031DL0800	PSR031DL0800Z	07945825086	3 pcs/box	
PSR031DS0900	PSR031DS0900Z	07945827823	PSR031DL0900	PSR031DL0900Z	07945827802	3 pcs/box	
32	PSR032DS0400	PSR032DS0400X	07945825013	PSR032DL0400	PSR032DL0400X	07945825087	1 pc/box
	PSR032DS0450	PSR032DS0450X	07945825014	PSR032DL0450	PSR032DL0450X	07945825088	1 pc/box
	PSR032DS0500	PSR032DS0500X	07945825015	PSR032DL0500	PSR032DL0500X	07945825089	1 pc/box
	PSR032DS0550	PSR032DS0550X	07945825016	PSR032DL0550	PSR032DL0550X	07945825090	1 pc/box
	PSR032DS0630	PSR032DS0630X	07945825017	PSR032DL0630	PSR032DL0630X	07945825091	1 pc/box
	PSR032DS0700	PSR032DS0700X	07945825021	PSR032DL0700	PSR032DL0700X	07945825092	1 pc/box
	PSR032DS0800	PSR032DS0800X	07945825022	PSR032DL0800	PSR032DL0800X	07945825141	1 pc/box
	PSR032DS0900	PSR032DS0900X	07945825023	PSR032DL0900	PSR032DL0900X	07945825142	1 pc/box
	PSR032DS1000	PSR032DS1000X	07945825025	PSR032DL1000	PSR032DL1000X	07945825143	1 pc/box
	PSR032DS1100	PSR032DS1100X	07945825026	PSR032DL1100	PSR032DL1100X	07945825144	1 pc/box
	PSR032DS1250	PSR032DS1250X	07945827824	PSR032DL1250	PSR032DL1250X	07945827803	1 pc/box
	PSR032DS1400	PSR032DS1400X	07945827825	PSR032DL1400	PSR032DL1400X	07945827804	1 pc/box
	PSR032DS1500	PSR032DS1500X	07945827826	PSR032DL1500	PSR032DL1500X	07945827805	1 pc/box
33	PSR033DS0450	PSR033DS0450X	07945825027	PSR033DL0450	PSR033DL0450X	07945825145	1 pc/box
	PSR033DS0500	PSR033DS0500X	07945825028	PSR033DL0500	PSR033DL0500X	07945825146	1 pc/box
	PSR033DS0550	PSR033DS0550X	07945825030	PSR033DL0550	PSR033DL0550X	07945825147	1 pc/box
	PSR033DS0630	PSR033DS0630X	07945825032	PSR033DL0630	PSR033DL0630X	07945825148	1 pc/box
	PSR033DS0700	PSR033DS0700X	07945825033	PSR033DL0700	PSR033DL0700X	07945825149	1 pc/box
	PSR033DS0800	PSR033DS0800X	07945825034	PSR033DL0800	PSR033DL0800X	07945825150	1 pc/box
	PSR033DS0900	PSR033DS0900X	07945825035	PSR033DL0900	PSR033DL0900X	07945825151	1 pc/box
	PSR033DS1000	PSR033DS1000X	07945825036	PSR033DL1000	PSR033DL1000X	07945825152	1 pc/box
	PSR033DS1100	PSR033DS1100X	07945825038	PSR033DL1100	PSR033DL1100X	07945825153	1 pc/box
	PSR033DS1250	PSR033DS1250X	07945825039	PSR033DL1250	PSR033DL1250X	07945825154	1 pc/box
	PSR033DS1400	PSR033DS1400X	07945825040	PSR033DL1400	PSR033DL1400X	07945825155	1 pc/box
	PSR033DS1500	PSR033DS1500X	07945825042	PSR033DL1500	PSR033DL1500X	07945825156	1 pc/box
	PSR033DS1600	PSR033DS1600X	07945825044	PSR033DL1600	PSR033DL1600X	07945825157	1 pc/box
	PSR033DS1800	PSR033DS1800X	07945825045	PSR033DL1800	PSR033DL1800X	07945825158	1 pc/box
	PSR033DS2000	PSR033DS2000X	07945825046	PSR033DL2000	PSR033DL2000X	07945825159	1 pc/box
	PSR033DS2250	PSR033DS2250X	07945827827	PSR033DL2250	PSR033DL2250X	07945827806	1 pc/box

POWR-SPEED® Fuse

PSR SERIES HIGH-SPEED SQUARE BODY

Ordering Information (cont.)

CASE SIZE	DIN 110 MM FIXING (DL)			BOX QUANTITY
	CATALOG NUMBER	ORDERING PART NUMBER	UPC	
70	PSR070DL0050	PSR070DL0050Z	07945825160	3 pcs/box
	PSR070DL0063	PSR070DL0063Z	07945825161	3 pcs/box
	PSR070DL0080	PSR070DL0080Z	07945825162	3 pcs/box
	PSR070DL0100	PSR070DL0100Z	07945825163	3 pcs/box
	PSR070DL0125	PSR070DL0125Z	07945825164	3 pcs/box
	PSR070DL0160	PSR070DL0160Z	07945825165	3 pcs/box
	PSR070DL0200	PSR070DL0200Z	07945825166	3 pcs/box
	PSR070DL0250	PSR070DL0250Z	07945825167	3 pcs/box
	PSR070DL0280	PSR070DL0280Z	07945825168	3 pcs/box
	PSR070DL0315	PSR070DL0315Z	07945825169	3 pcs/box
	PSR070DL0350	PSR070DL0350Z	07945827807	3 pcs/box
PSR070DL0400	PSR070DL0400Z	07945827808	3 pcs/box	
71	PSR071DL0160	PSR071DL0160Z	07945825170	3 pcs/box
	PSR071DL0200	PSR071DL0200Z	07945825171	3 pcs/box
	PSR071DL0250	PSR071DL0250Z	07945825172	3 pcs/box
	PSR071DL0280	PSR071DL0280Z	07945825173	3 pcs/box
	PSR071DL0315	PSR071DL0315Z	07945825174	3 pcs/box
	PSR071DL0350	PSR071DL0350Z	07945825175	3 pcs/box
	PSR071DL0400	PSR071DL0400Z	07945825176	3 pcs/box
	PSR071DL0450	PSR071DL0450Z	07945825177	3 pcs/box
	PSR071DL0500	PSR071DL0500Z	07945827809	3 pcs/box
	PSR071DL0550	PSR071DL0550Z	07945827810	3 pcs/box
PSR071DL0630	PSR071DL0630Z	07945827811	3 pcs/box	
72	PSR072DL0250	PSR072DL0250X	07945825178	1 pc/box
	PSR072DL0280	PSR072DL0280X	07945825179	1 pc/box
	PSR072DL0315	PSR072DL0315X	07945825180	1 pc/box
	PSR072DL0350	PSR072DL0350X	07945825181	1 pc/box
	PSR072DL0400	PSR072DL0400X	07945825182	1 pc/box
	PSR072DL0450	PSR072DL0450X	07945825183	1 pc/box
	PSR072DL0500	PSR072DL0500X	07945825184	1 pc/box
	PSR072DL0550	PSR072DL0550X	07945825185	1 pc/box
	PSR072DL0630	PSR072DL0630X	07945825186	1 pc/box
	PSR072DL0700	PSR072DL0700X	07945827812	1 pc/box
	PSR072DL0800	PSR072DL0800X	07945827813	1 pc/box
	PSR072DL0900	PSR072DL0900X	07945827814	1 pc/box
PSR072DL1000	PSR072DL1000X	07945827815	1 pc/box	
73	PSR073DL0315	PSR073DL0315X	07945825187	1 pc/box
	PSR073DL0350	PSR073DL0350X	07945825188	1 pc/box
	PSR073DL0400	PSR073DL0400X	07945825189	1 pc/box
	PSR073DL0450	PSR073DL0450X	07945825190	1 pc/box
	PSR073DL0500	PSR073DL0500X	07945825191	1 pc/box
	PSR073DL0550	PSR073DL0550X	07945825192	1 pc/box
	PSR073DL0630	PSR073DL0630X	07945825193	1 pc/box
	PSR073DL0700	PSR073DL0700X	07945825194	1 pc/box
	PSR073DL0800	PSR073DL0800X	07945827816	1 pc/box
	PSR073DL0900	PSR073DL0900X	07945827817	1 pc/box
	PSR073DL1000	PSR073DL1000X	07945827818	1 pcsbox
	PSR073DL1100	PSR073DL1100X	07945827819	1 pc/box
	PSR073DL1250	PSR073DL1250X	07945827820	1 pc/box
	PSR073DL1400	PSR073DL1400X	07945827821	1 pc/box

POWR-SPEED® Fuse

PSR SERIES HIGH-SPEED SQUARE BODY

Dimensions (DS and DL)

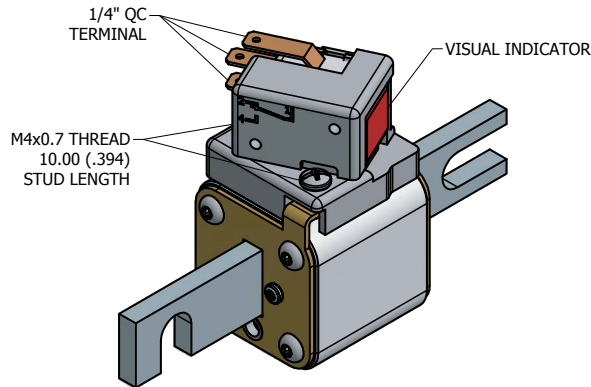
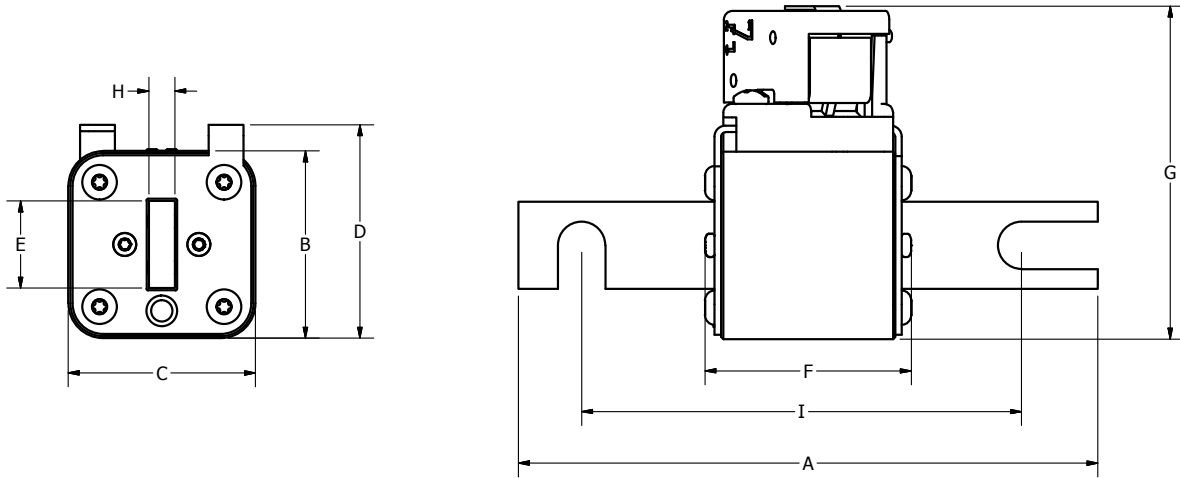

DIMENSIONS MM (IN)												
CASE SIZE	MOUNTING STYLE	A	B	C	D	E	F	G	H	I	RECOMMENDED FASTENER	TIGHTENING TORQUE (REFERENCE ONLY)
30	DIN 80 [DS]	109.0 (4.29)	43.0 (1.69)	43.0 (1.69)	49.0 (1.93)	20.0 (0.79)	47.7 (1.88)	77.9 (3.07)	6.0 (0.24)	77.8 (3.06)	10 mm (3/8)	26 Nm
	DIN 110 [DL]	132.5 (5.22)	43.0 (1.69)	43.0 (1.69)	49.0 (1.93)	20.0 (0.79)	47.7 (1.88)	77.9 (3.07)	6.0 (0.24)	101.8 (4.01)	10 mm (3/8)	26 Nm
31	DIN 80 [DS]	109.2 (4.30)	51.5 (2.03)	51.5 (2.03)	57.5 (2.26)	25.0 (0.98)	49.2 (1.94)	86.4 (3.40)	6.0 (0.24)	77.8 (3.06)	10 mm (3/8)	26 Nm
	DIN 110 [DL]	133.2 (5.24)	51.5 (2.03)	51.5 (2.03)	57.5 (2.26)	25.0 (0.98)	49.2 (1.94)	86.4 (3.40)	6.0 (0.24)	101.8 (4.01)	10 mm (3/8)	26 Nm
32	DIN 80 [DS]	109.2 (4.30)	60.0 (2.36)	60.0 (2.36)	66.0 (2.60)	25.0 (0.98)	49.2 (1.94)	94.9 (3.74)	6.0 (0.24)	77.8 (3.06)	10 mm (3/8)	26 Nm
	DIN 110 [DL]	133.2 (5.24)	60.0 (2.36)	60.0 (2.36)	66.0 (2.60)	25.0 (0.98)	49.2 (1.94)	94.9 (3.74)	6.0 (0.24)	101.8 (4.01)	10 mm (3/8)	26 Nm
33	DIN 80 [DS]	109.2 (4.30)	73.5 (2.89)	73.5 (2.89)	79.5 (3.13)	36.0 (1.42)	50.2 (1.98)	108.4 (4.27)	6.0 (0.24)	77.8 (3.06)	10 mm (3/8)	26 Nm
	DIN 110 [DL]	133.2 (5.24)	73.5 (2.89)	73.5 (2.89)	79.5 (3.13)	36.0 (1.42)	50.2 (1.98)	108.4 (4.27)	6.0 (0.24)	101.8 (4.01)	10 mm (3/8)	26 Nm
70	DIN 110 [DL]	133.0 (5.24)	43.0 (1.69)	43.0 (1.69)	49.0 (1.93)	20.0 (0.79)	71.7 (2.82)	77.9 (3.07)	6.0 (0.24)	101.8 (4.01)	10 mm (3/8)	26 Nm
71	DIN 110 [DL]	133.2 (5.24)	51.5 (2.03)	51.5 (2.03)	57.5 (2.26)	25.0 (0.98)	73.2 (2.88)	86.4 (3.40)	6.0 (0.24)	101.8 (4.01)	10 mm (3/8)	26 Nm
72	DIN 110 [DL]	133.2 (5.24)	60.0 (2.36)	60.0 (2.36)	66.0 (2.60)	25.0 (0.98)	73.2 (2.88)	94.9 (3.74)	6.0 (0.24)	101.8 (4.01)	10 mm (3/8)	26 Nm
73	DIN 110 [DL]	133.2 (5.24)	73.5 (2.89)	73.5 (2.89)	79.5 (3.13)	36.0 (1.42)	74.2 (2.92)	108.4 (4.27)	6.0 (0.24)	101.8 (4.01)	10 mm (3/8)	26 Nm

POWR-SPEED® Fuse

PSR SERIES HIGH-SPEED SQUARE BODY

Time Current Curve (30 Case Size)

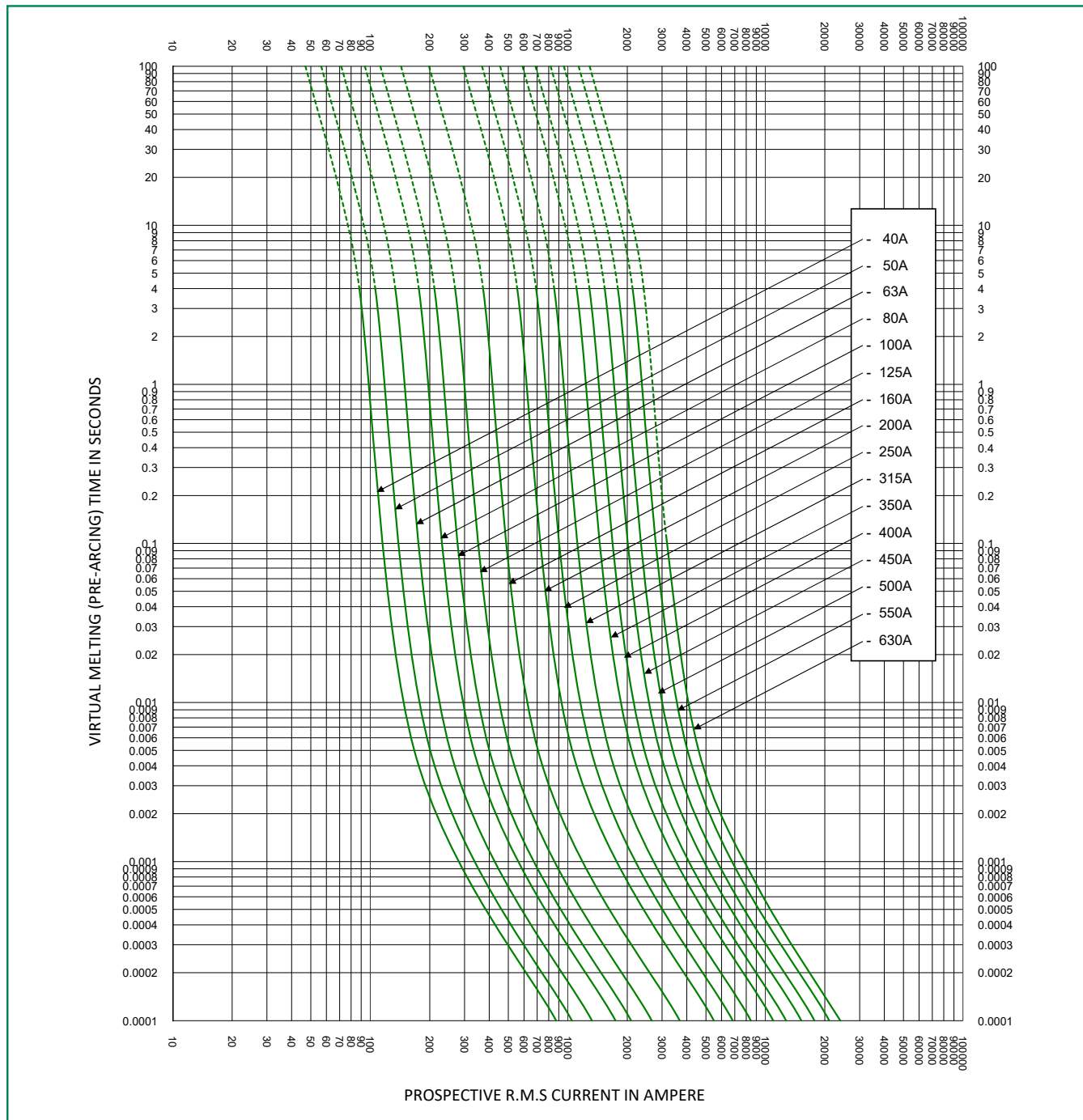

* Dc minimum breaking capacity = 9 x I_n

POWR-SPEED® Fuse

PSR SERIES HIGH-SPEED SQUARE BODY

Time Current Curve (31 Case Size)

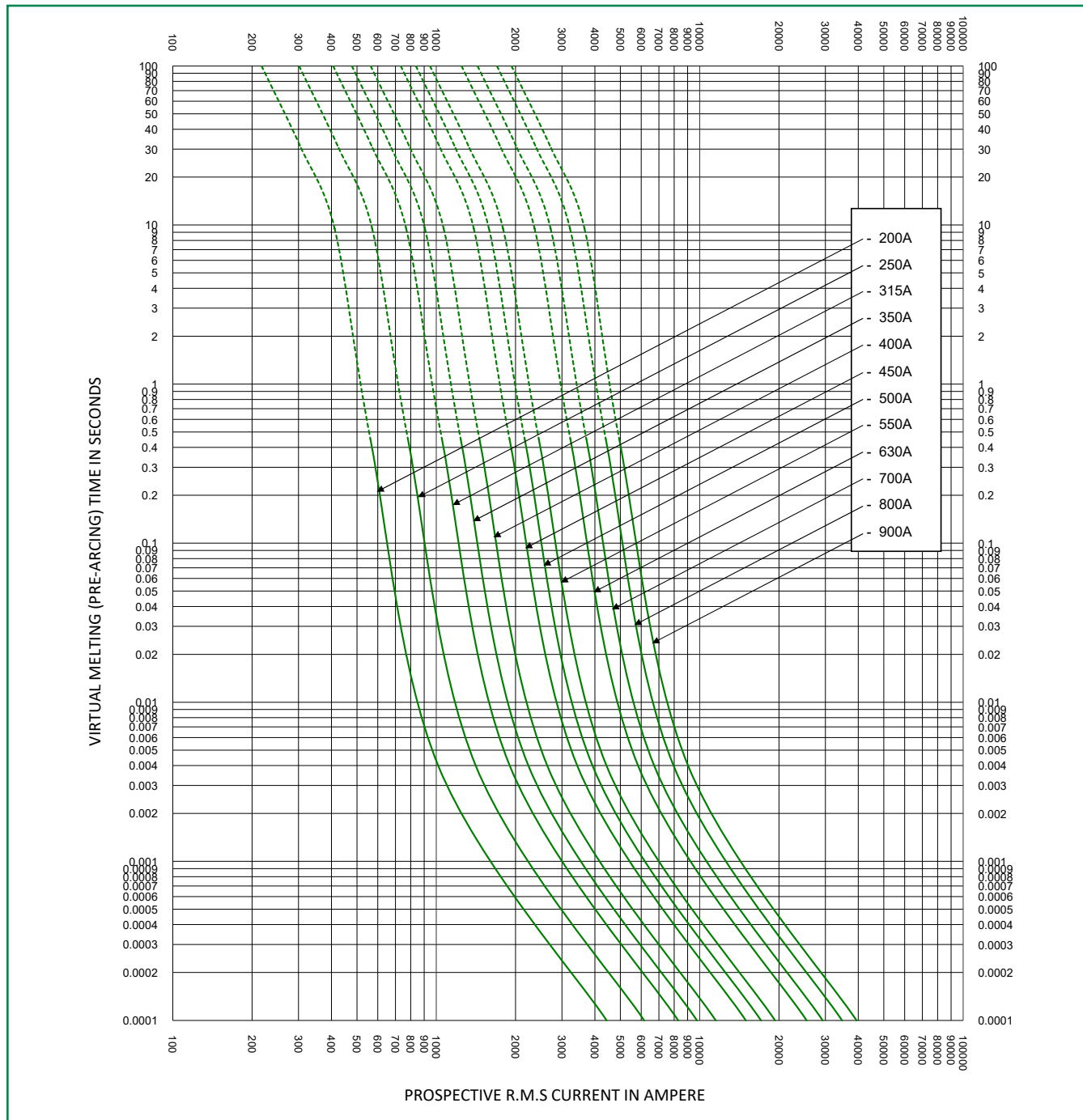

* Dc minimum breaking capacity = 9 x In

Time Current Curve (32 Case Size)

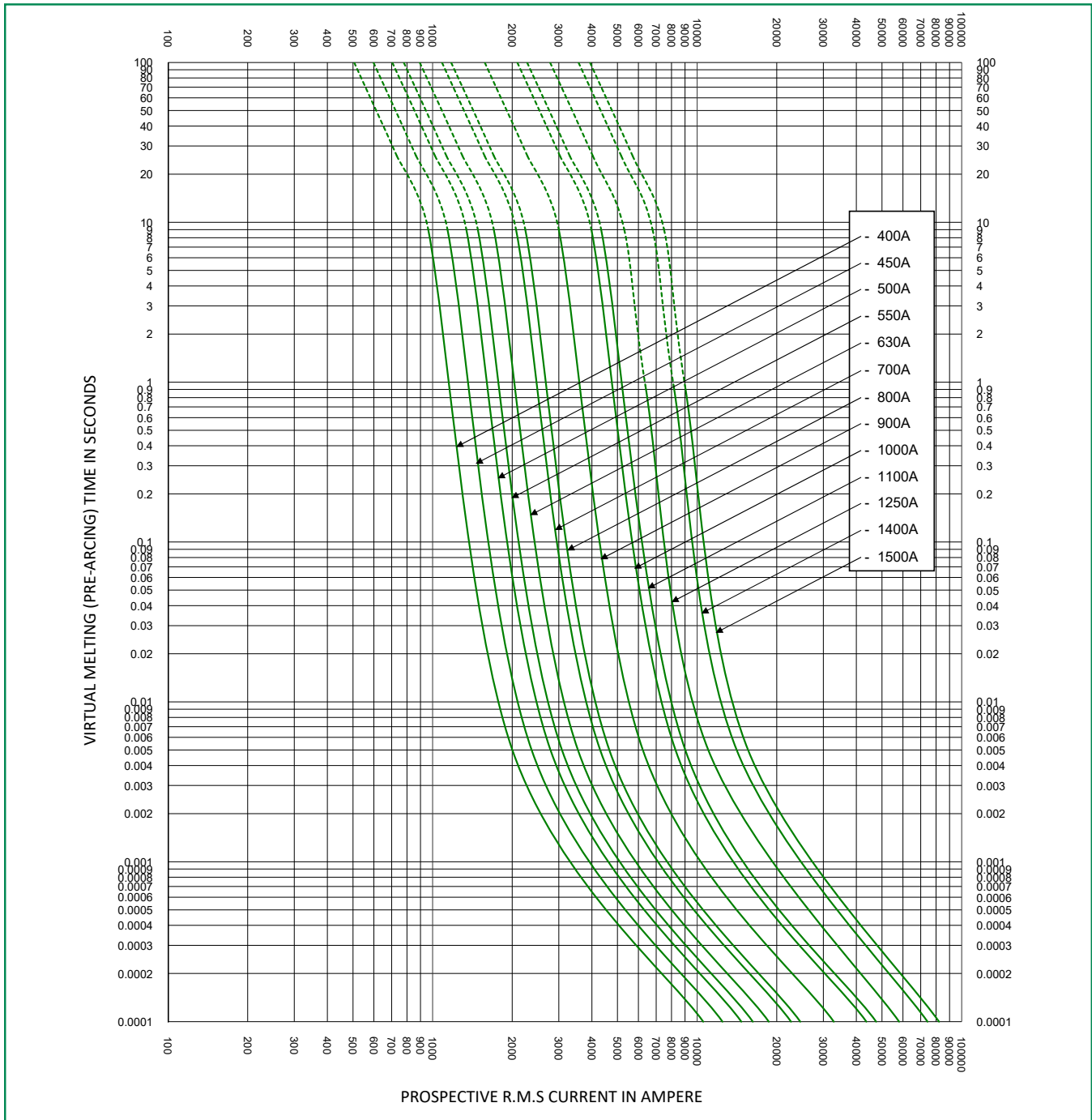

* Dc minimum breaking capacity = 9 x In

POWR-SPEED® Fuse

PSR SERIES HIGH-SPEED SQUARE BODY

Time Current Curve (33 Case Size)

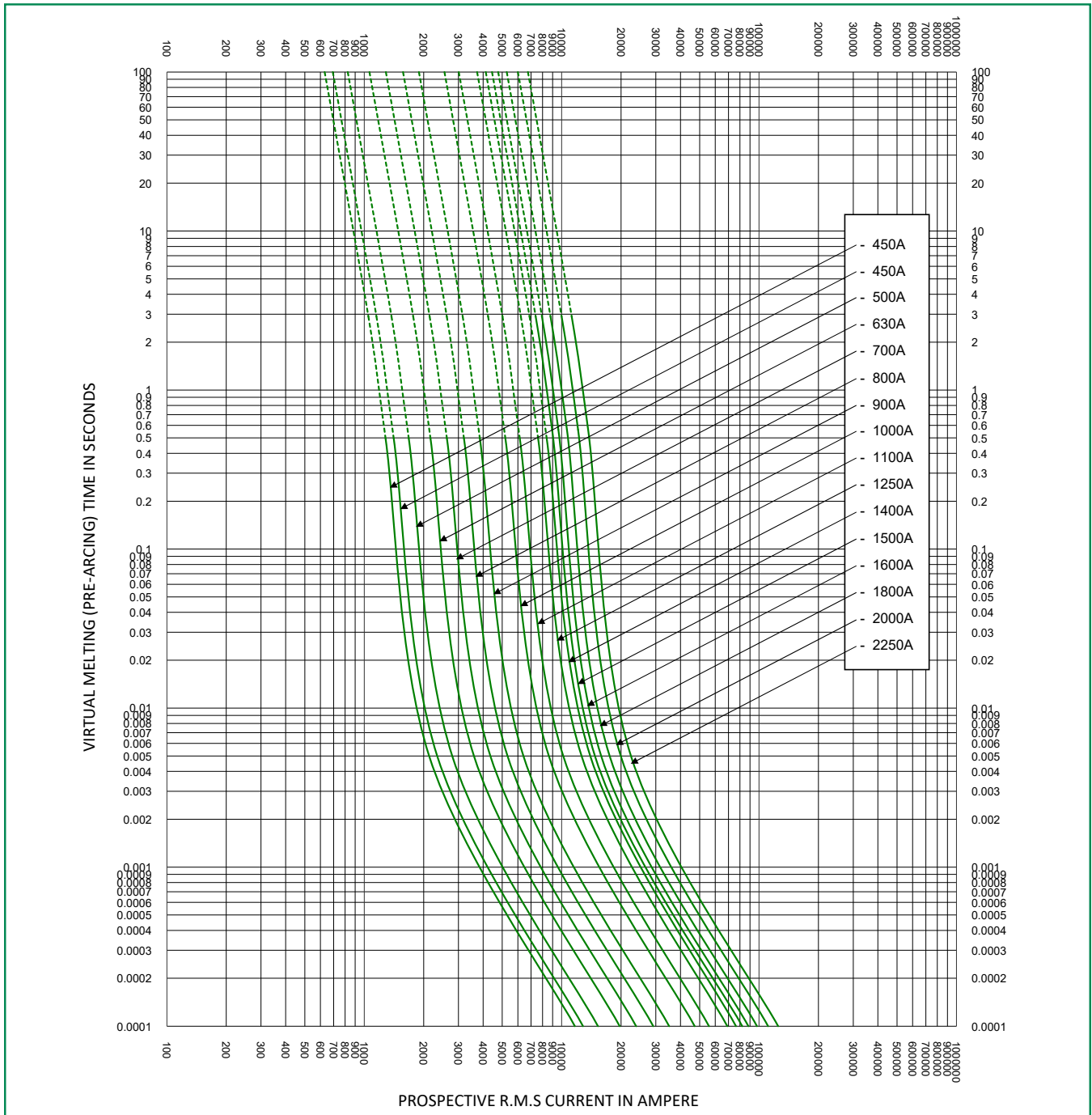

* Dc minimum breaking capacity = 9 x In

POWR-SPEED® Fuse

PSR SERIES HIGH-SPEED SQUARE BODY

Time Current Curve (70 Case Size)

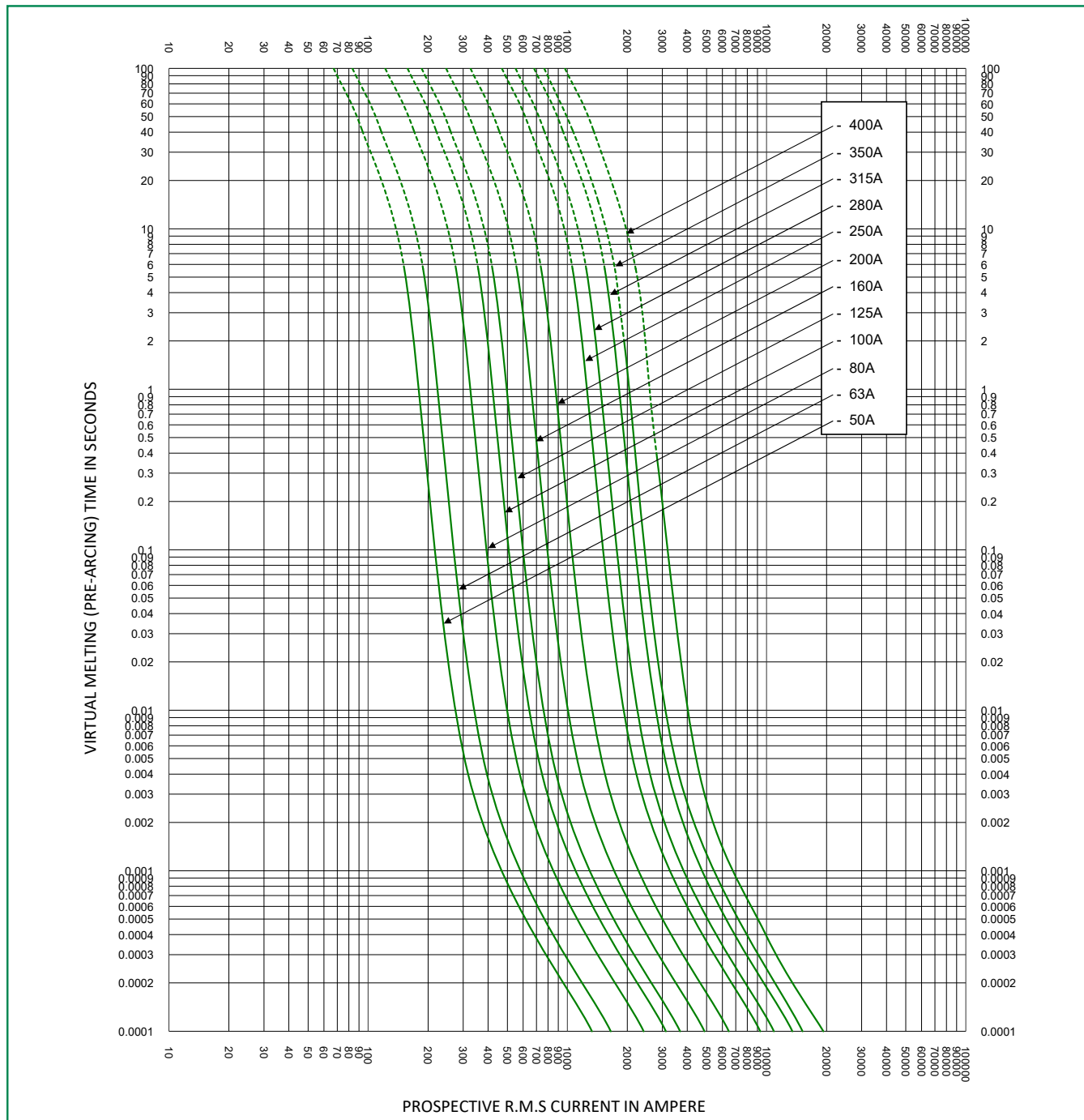

* Dc minimum breaking capacity = 9 x I_n

Time Current Curve (71 Case Size)

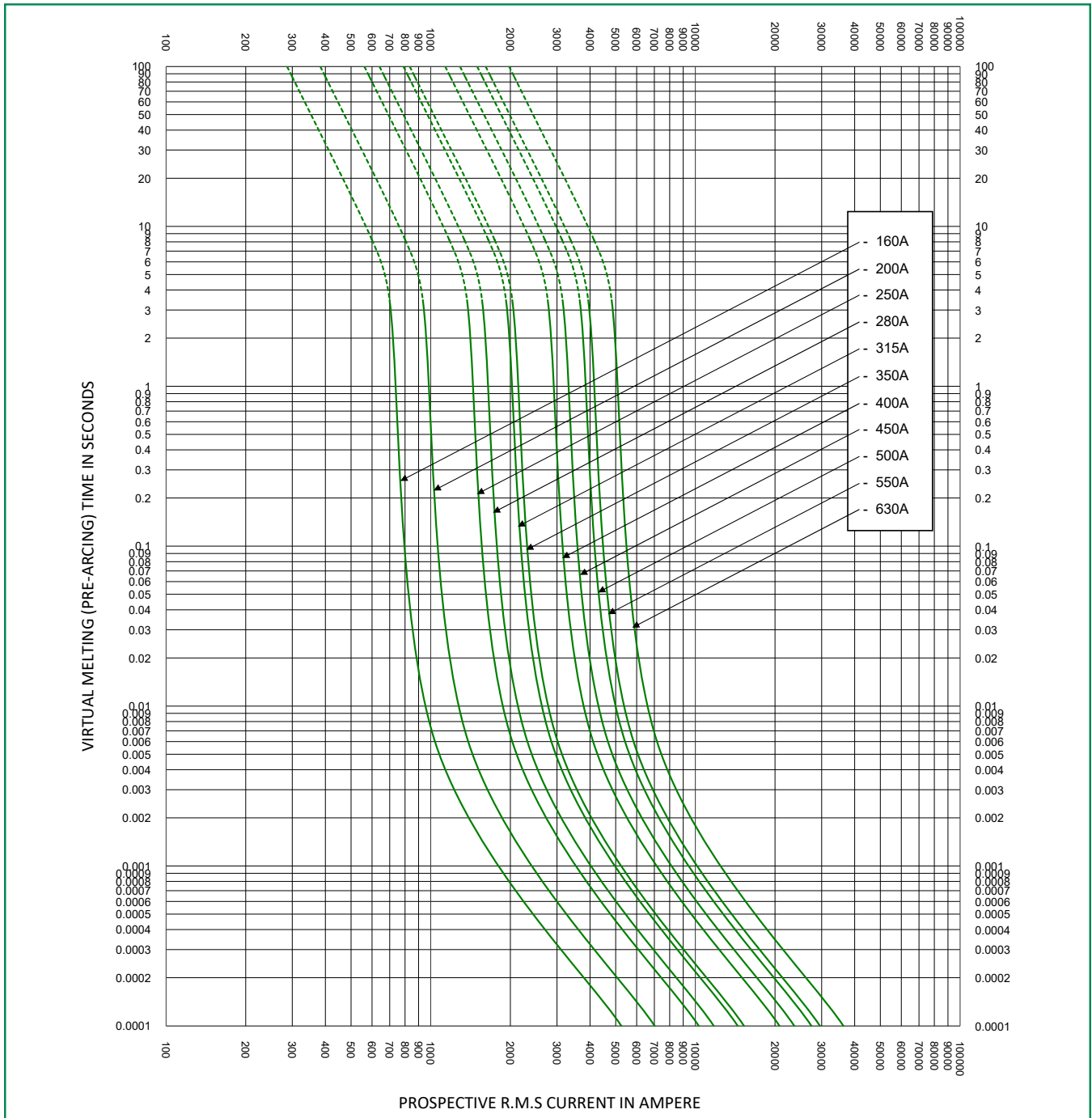

* Dc minimum breaking capacity = 9 x In

POWR-SPEED® Fuse

PSR SERIES HIGH-SPEED SQUARE BODY

Time Current Curve (72 Case Size)

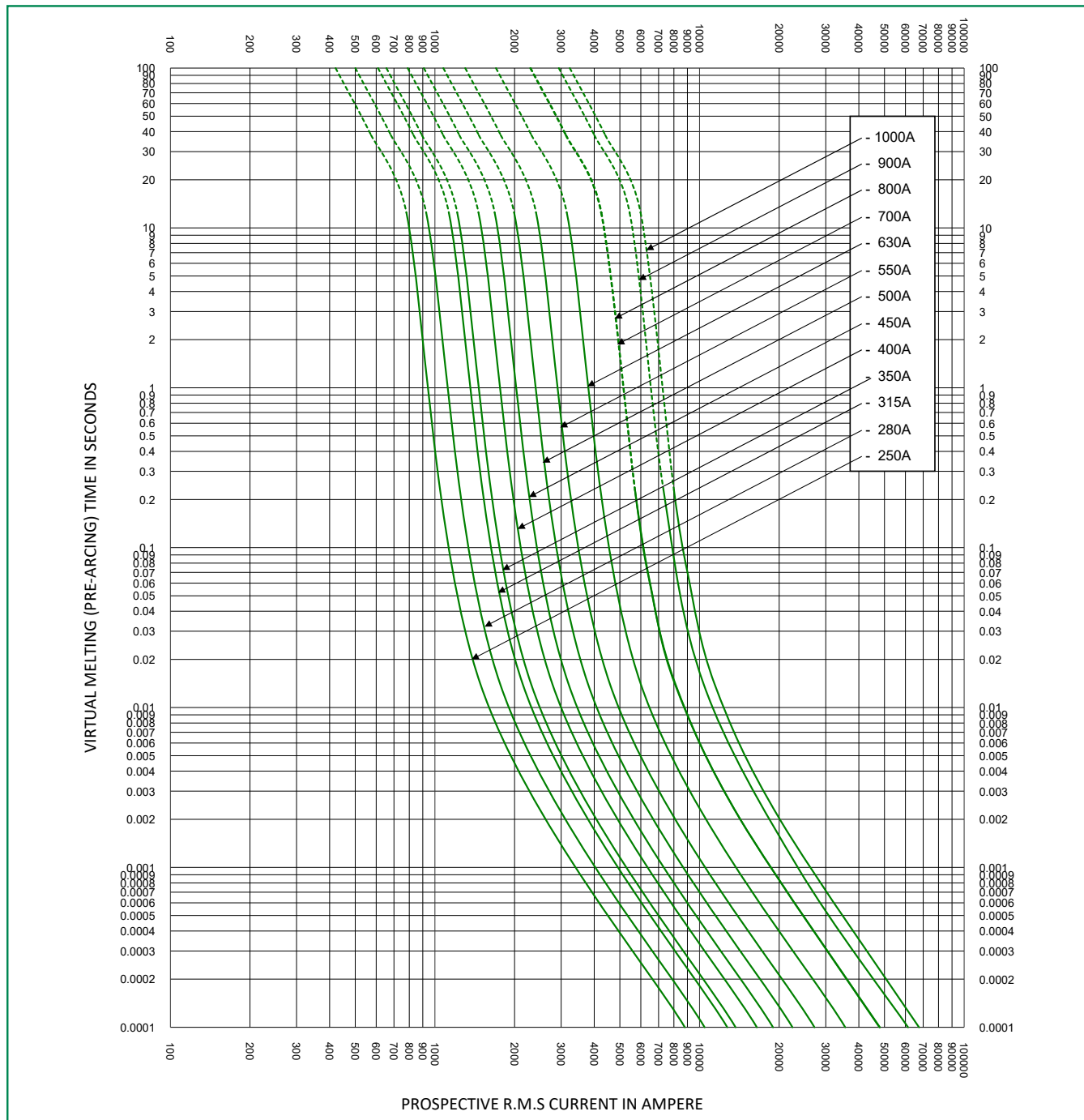

* Dc minimum breaking capacity = 9 x In

POWR-SPEED® Fuse

PSR SERIES HIGH-SPEED SQUARE BODY

Time Current Curve (73 Case Size)

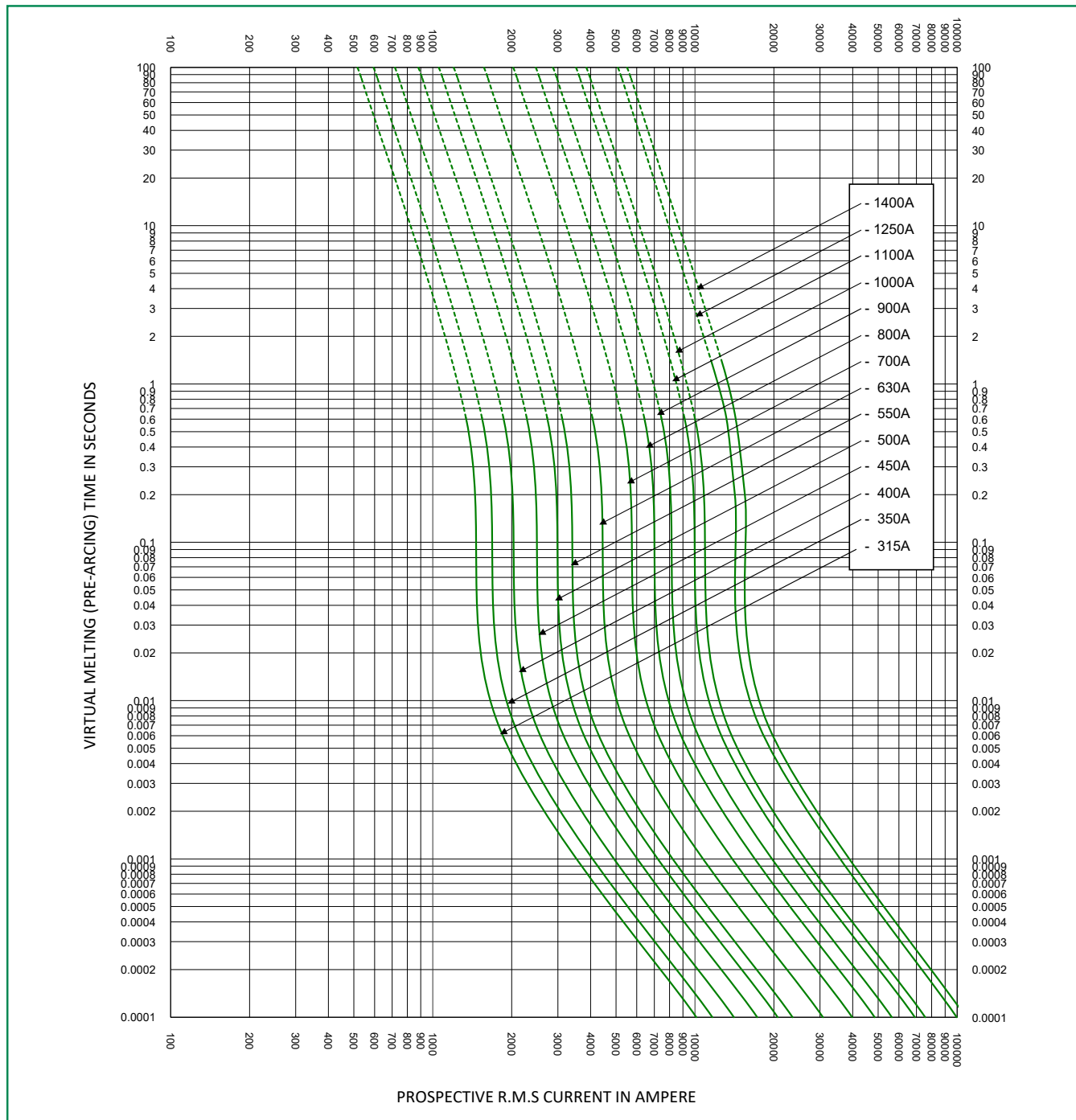

* Dc minimum breaking capacity = 9 x I_n

Peak Let-Through Curve (30 Case Size)

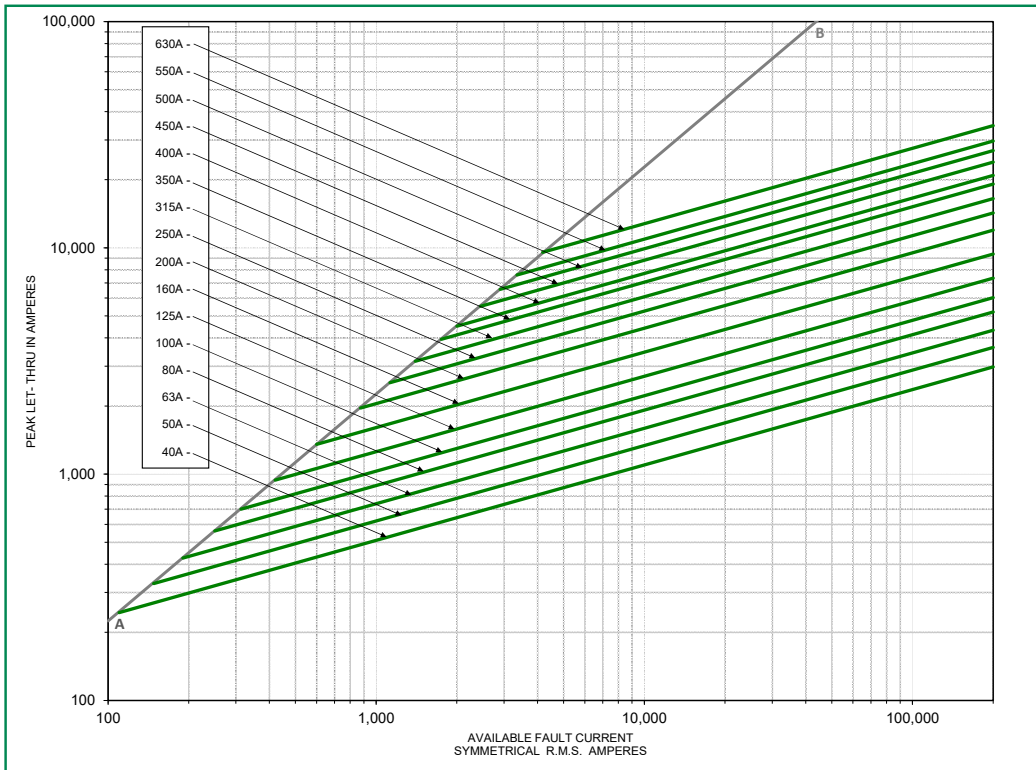

Peak Let-Through Curve (31 Case Size)

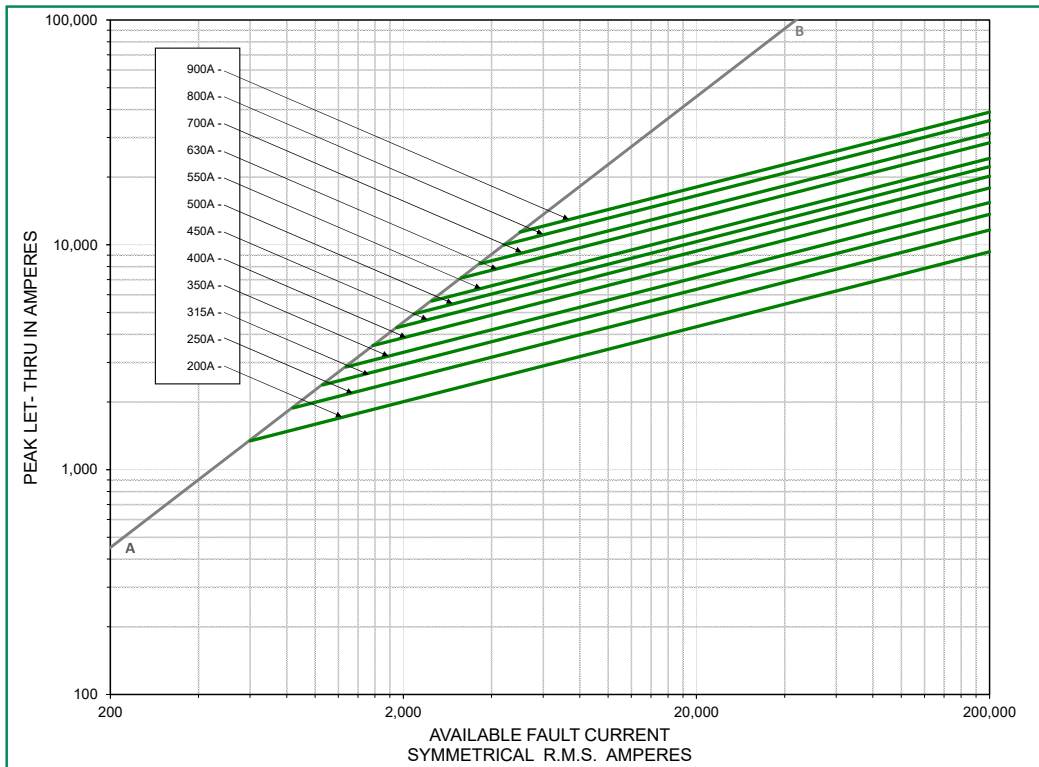

Peak Let-Thru Curve (32 Case Size)

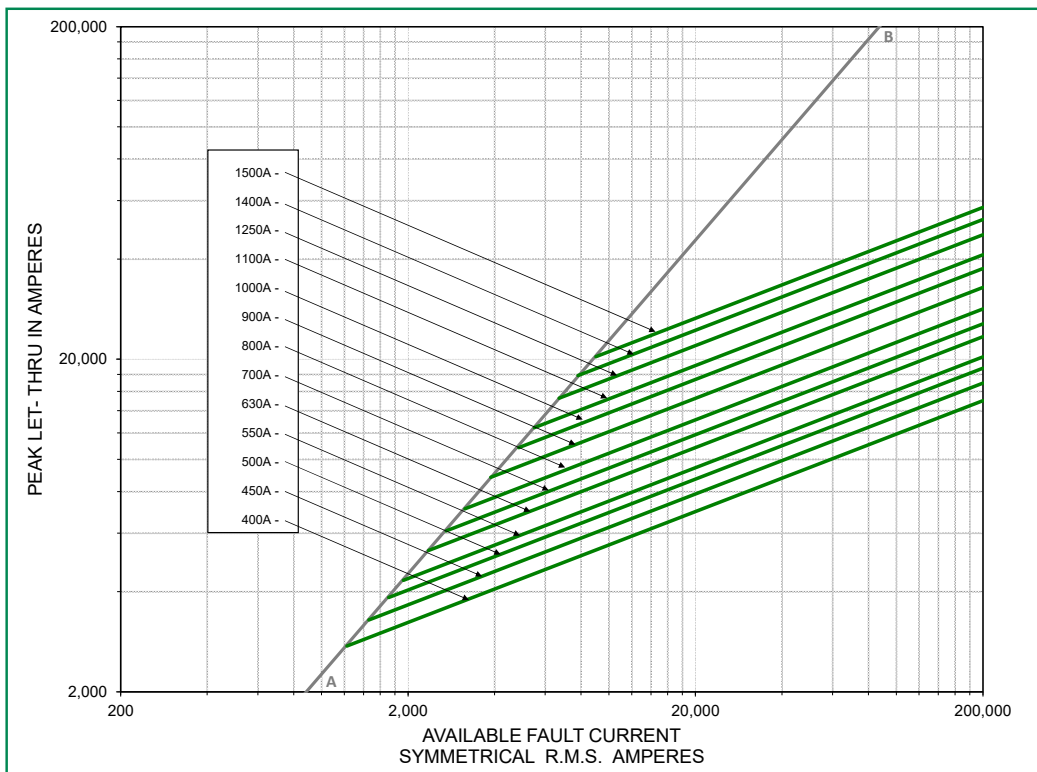

Peak Let-Thru Curve (33 Case Size)

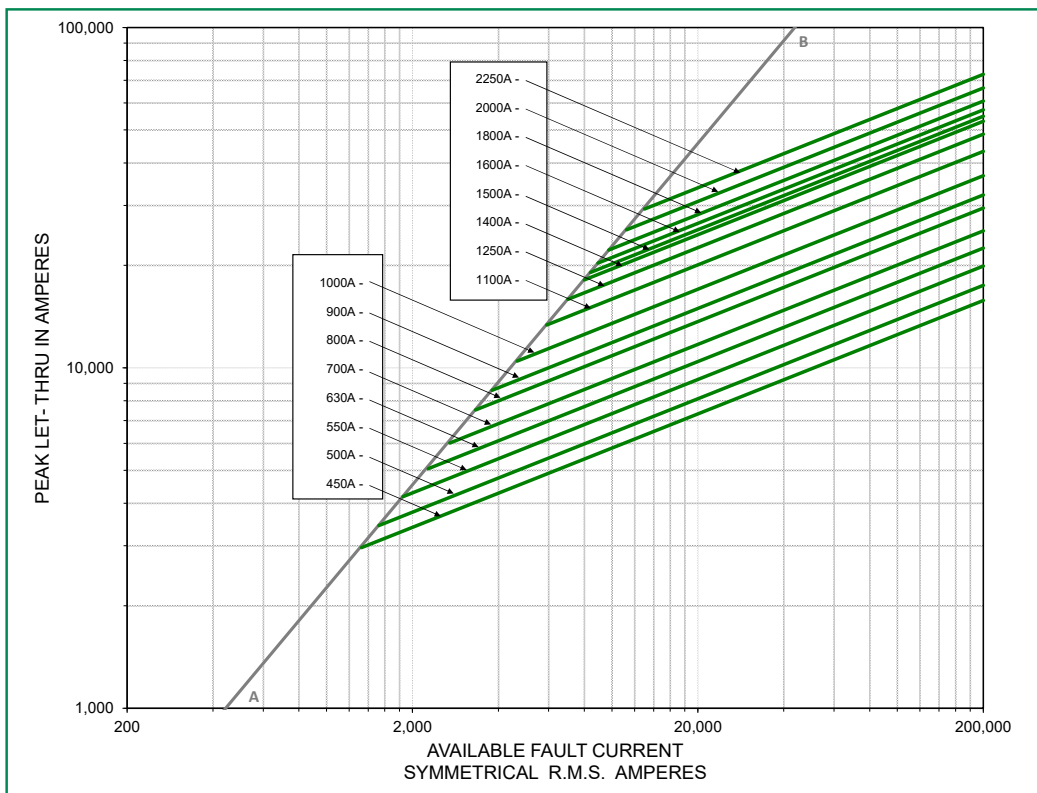

Peak Let-Thru Curve (70 Case Size)

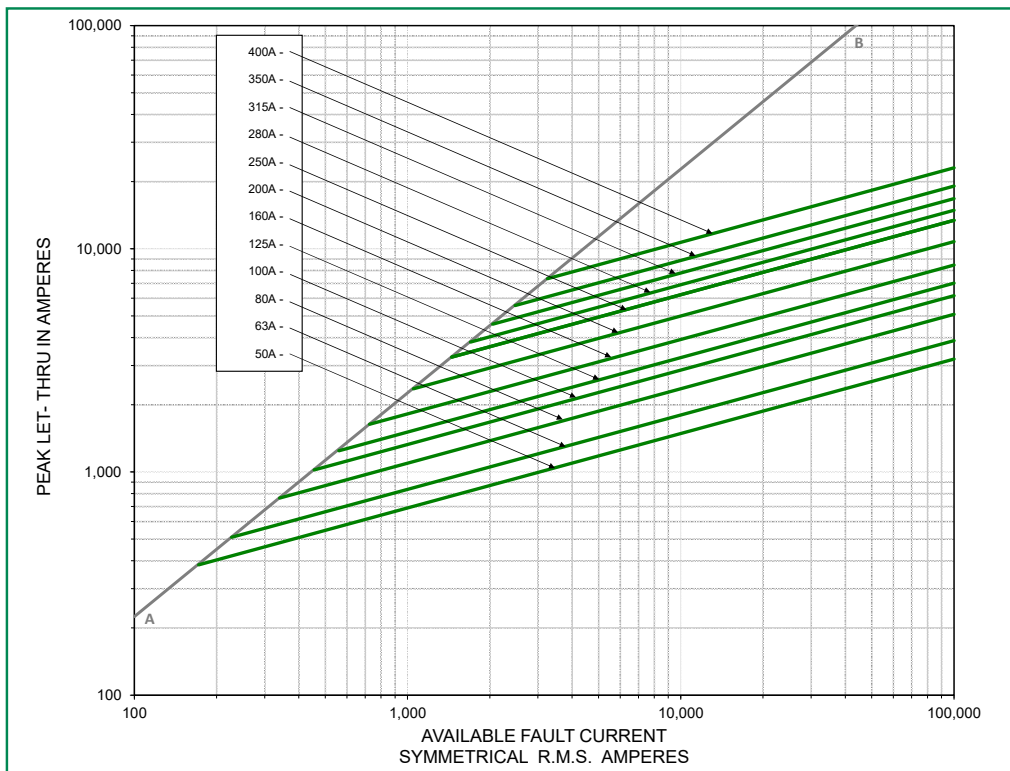

Peak Let-Thru Curve (71 Case Size)

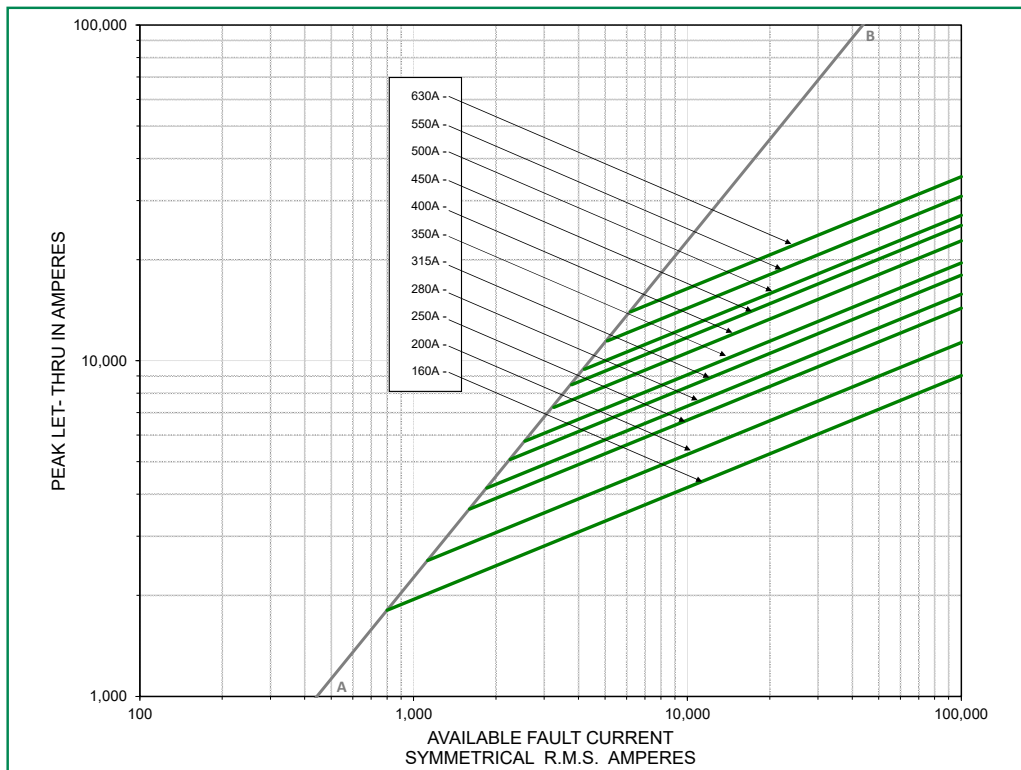

Peak Let-Thru Curve (72 Case Size)

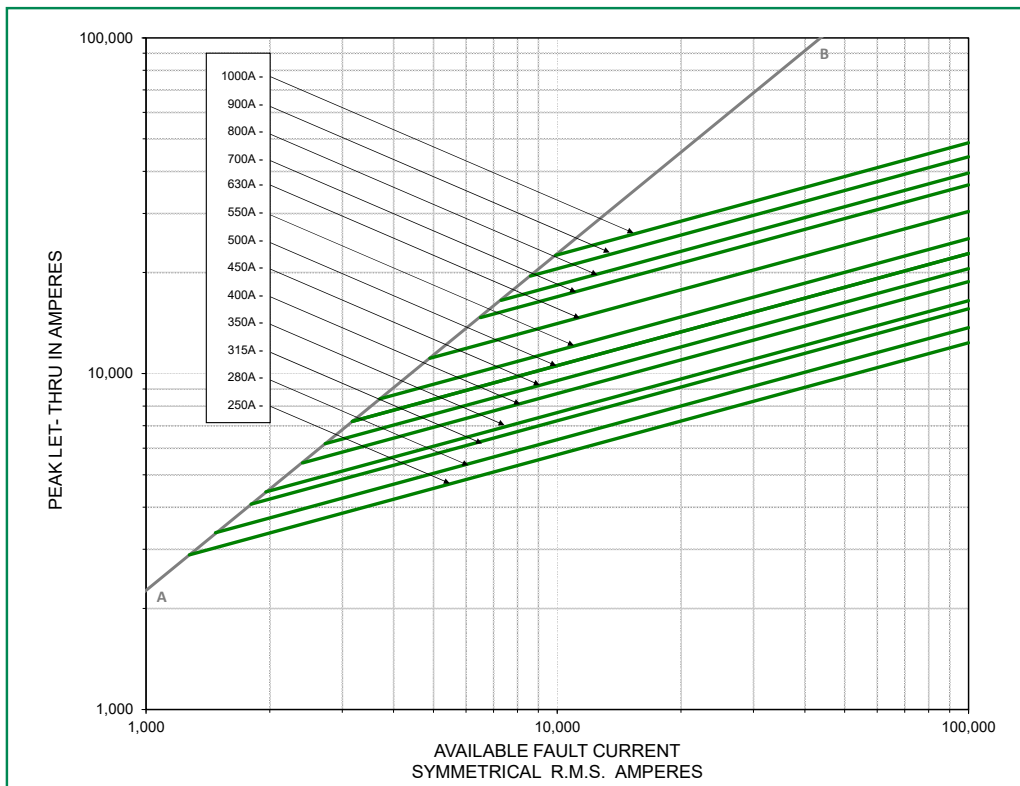

Peak Let-Thru Curve (73 Case Size)

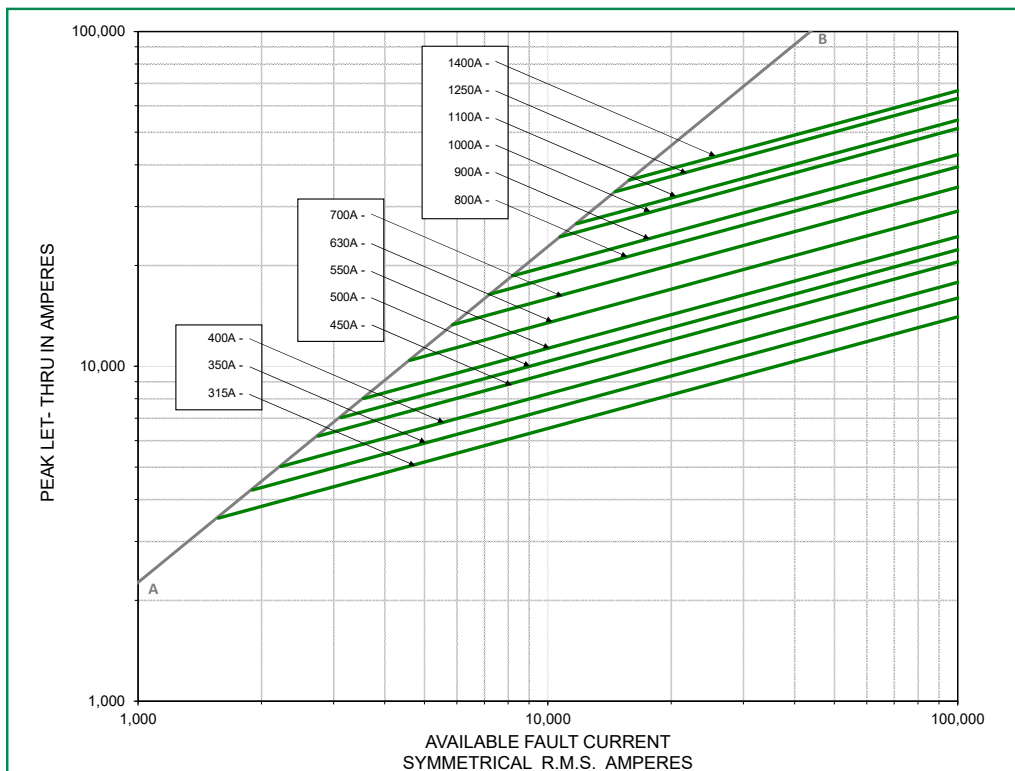

Total Clearing I²t Correction Factor Curve
 (30, 31, 32 and 33 Case Sizes)

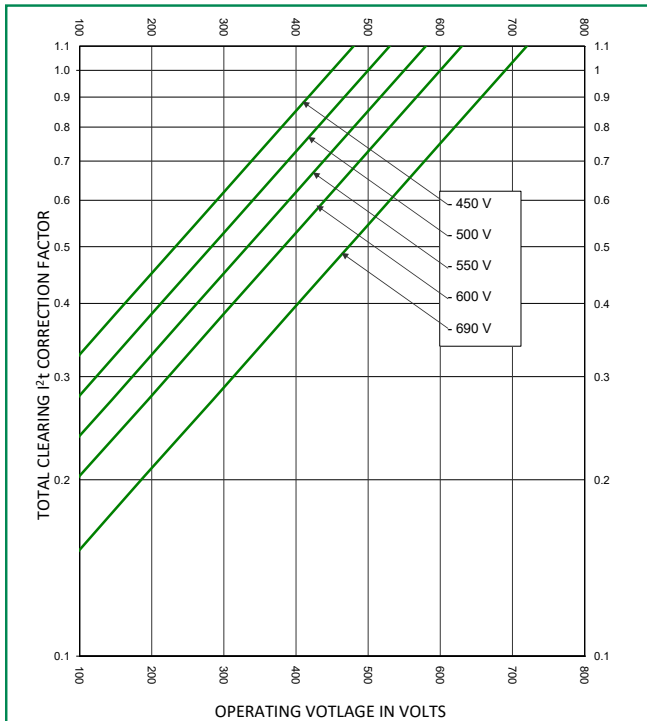

Total Clearing I²t Correction Factor Curve
 (70, 71, 72 and 73 Case Sizes)

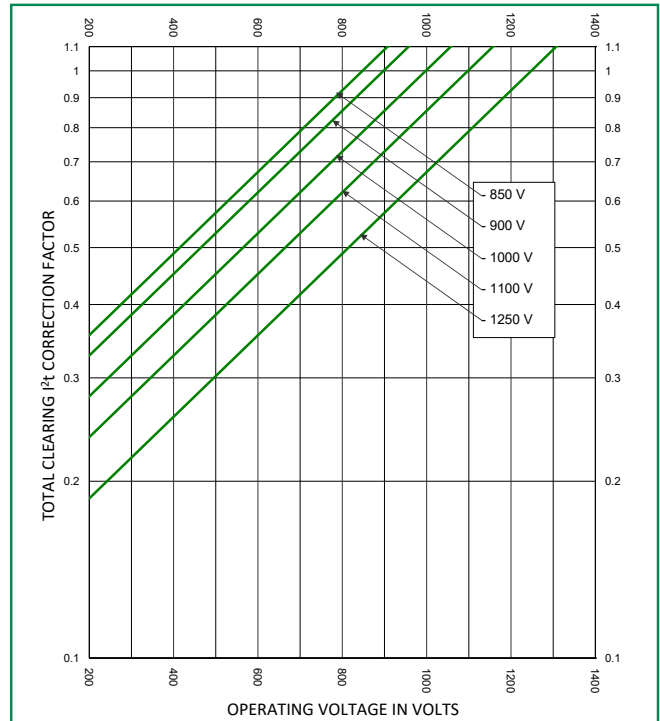

Peak Arc Voltage Curve
 (30, 31, 32 and 33 Case Sizes)

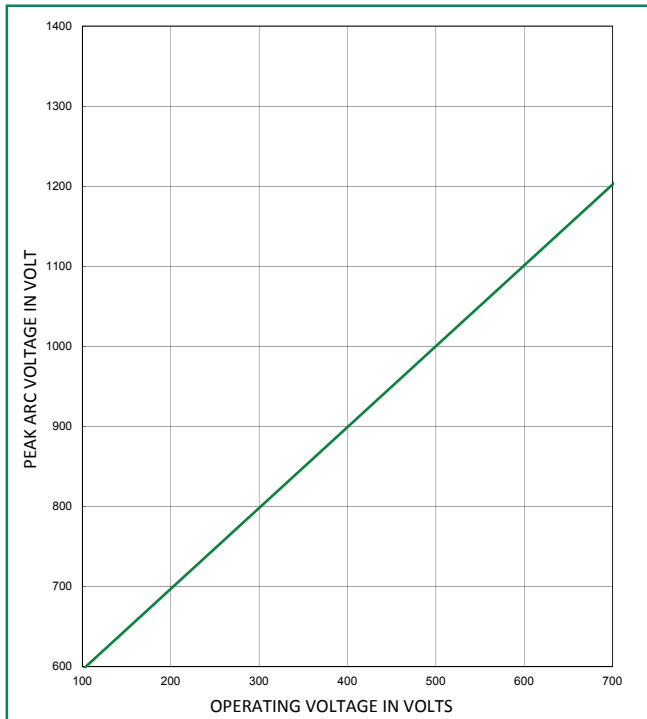

Peak Arc Voltage Curve
 (70, 71, 72 and 73 Case Sizes)

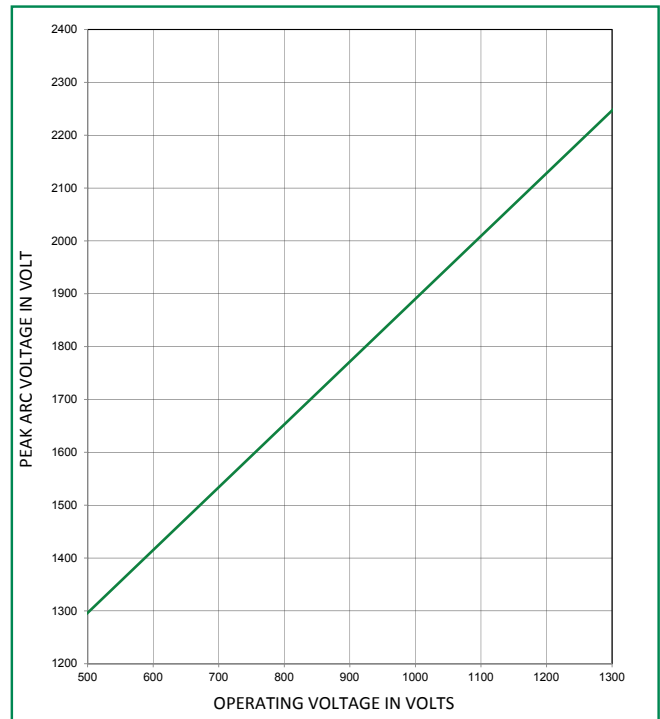

Temperature Derating Curve
 (temperature of air immediately surrounding fuse)

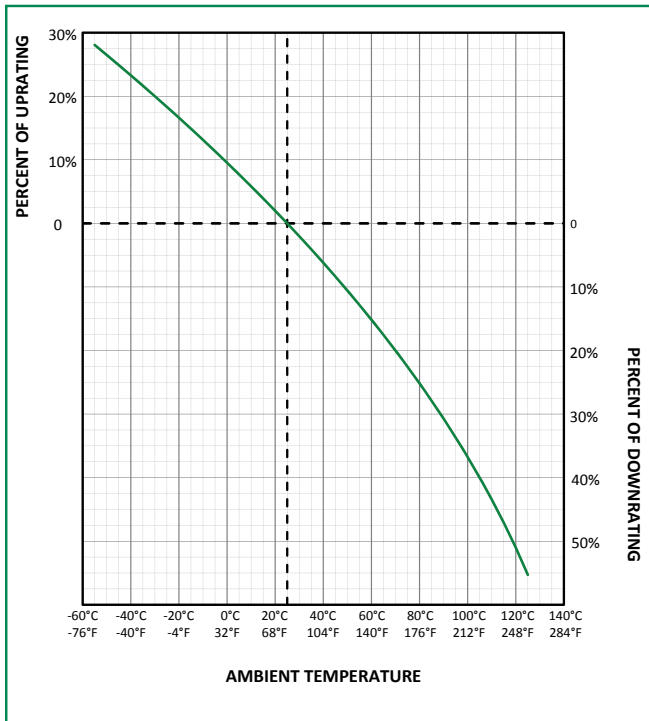

Watts Loss Correction Factor Curve

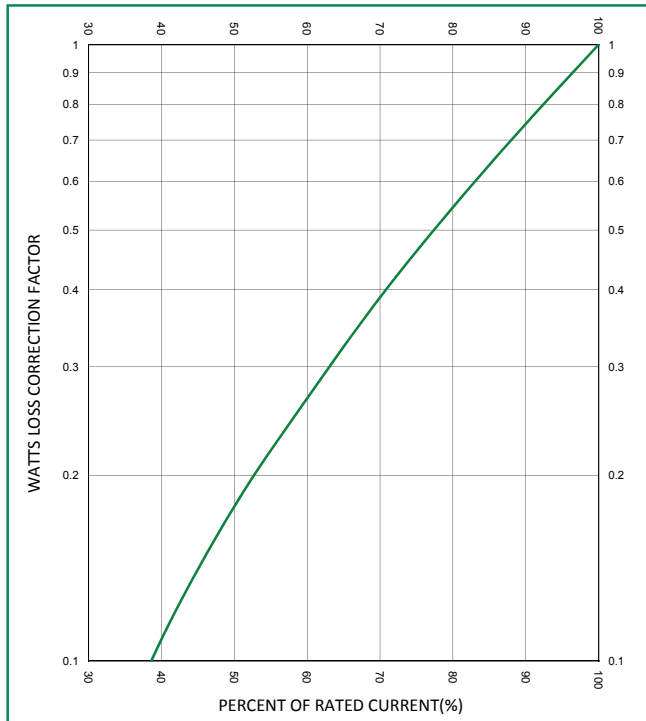

Disclaimer Notice – Information furnished is believed to be accurate and reliable. However, users should independently evaluate the suitability of and test each product selected for their own applications. Littelfuse products are not designed for, and may not be used in, all applications. Read complete Disclaimer Notice at www.littelfuse.com/product-disclaimer.

X-ON Electronics

Largest Supplier of Electrical and Electronic Components

Click to view similar products for [Specialty Fuses](#) category:

Click to view products by [Littelfuse](#) manufacturer:

Other Similar products are found below :

[ECF-1](#) [ECF-1/2](#) [ECF-2](#) [ECF-3](#) [ECF-4](#) [170M1418](#) [N-2-1/2](#) [N-3-2/10](#) [S-2](#) [2D16](#) [170M1564D](#) [170M4241](#) [ABS-25](#) [ABS-30](#) [ABS-8](#) [FWP-25A14FI](#) [FWP-80A22FI](#) [30CIF06](#) [TJD](#) [TPL-BL](#) [KAB-25](#) [KLC40](#) [WKV](#) [10D27](#) [NITD25](#) [04450080FX850](#) [NITD16](#) [ECF-5](#) [TDC180-10](#) [TPM-25](#) [170M3509](#) [DEO200](#) [004117001](#) [45ET](#) [170M5810D](#) [10H07C](#) [SDL-2](#) [CC12M10A](#) [TDC600-2-R](#) [CBW57-ES-7A-5H](#) [CBW57-HB-15A-P](#) [CBW57-PS-15A-5X](#) [CBW58-HL4-30A-5C](#) [CBW58-HS-15A-5C](#) [CBW58-HS-20A-5C](#) [0AALBK300-BA](#) [170M8211](#) [STD2](#) [STD4](#) [4D27FB](#)