

SxX8xSx Series
EV Series 0.8 A Sensitive SCRs

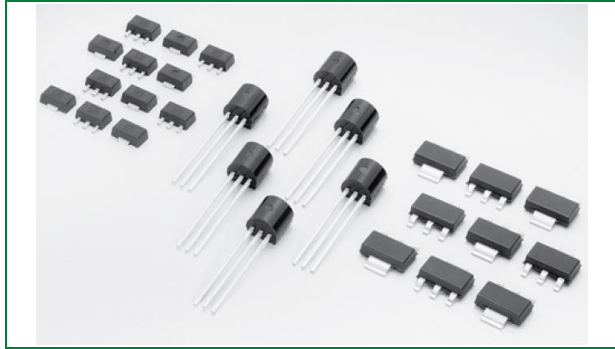

Agency Approvals and Environmental

Environmental Approvals

RoHS **HF**

Product Summary

Characteristic	Value	Unit
$I_{T(RMS)}$	0.8	A
V_{DRM} / V_{RRM}	400, 600, or 800	V
I_{GT}	5 to 200	μA

Schematic Symbol

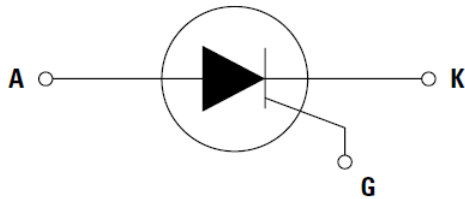

Product Description

This new component series offers high static dv/dt and low turn off time (t_q) sensitive SCR. It is specifically designed for Ground Fault Circuit Interrupter (GFCI) and Gas Ignition applications. All SCRs junctions are glass-passivated to ensure long term reliability and parametric stability.

Features

- Surge capability > 10 A
- Blocking voltage (V_{DRM} / V_{RRM}) capability up to 800 V
- High dv/dt noise immunity
- Improved turn-off time (t_q) < 25 μsec
- Sensitive gate for direct microprocessor interface
- Through-hole and surface-mount packages
- RoHS compliant and Halogen-Free

Applications

The SxX8xSx EV series is specifically designed for Ground Fault Circuit Interrupter (GFCI) and gas ignition applications.

- 1. Maximum Ratings.....3
- 2. Thermal Characteristics3
- 3. Electrical Characteristics ($T_J = 25\text{ }^\circ\text{C}$ unless otherwise specified)3
- 4. Static Characteristics ($T_J = 25\text{ }^\circ\text{C}$ unless otherwise specified).....3
- 5. Performance Curves4
- 6. Soldering Parameters7
- 7. Physical Specifications.....7
- 8. Environmental Specifications.....7
- 9. Design Considerations.....8
- 10. Package Dimensions9
- 11. Part Numbering and Marking.....10
- 12. Product Selector11
- 13. Packing Options.....11
- 14. Packing Specifications11

1. Maximum Ratings

Symbol	Characteristic	Conditions		Value	Unit
$I_{T(RMS)}$	RMS On-state Current (Full Sine Wave)	TO-92	$T_C = 55\text{ }^\circ\text{C}$	0.8	A
		SOT-89	$T_C = 60\text{ }^\circ\text{C}$		
		SOT-223	$T_L = 60\text{ }^\circ\text{C}$		
$I_{T(AV)}$	Average On-state Current	TO-92	$T_C = 55\text{ }^\circ\text{C}$	0.51	A
		SOT-89	$T_C = 60\text{ }^\circ\text{C}$		
		SOT-223	$T_L = 60\text{ }^\circ\text{C}$		
I_{TSM}	Non-repetitive Surge Peak On-state Current (Single Cycle, $T_{J,Initial} = 25\text{ }^\circ\text{C}$)	TO-92	$f = 50\text{ Hz}$	8	A
		SOT-89	$f = 60\text{ Hz}$	10	
		SOT-223			
I^2t	I^2t Value for Fusing	$t_p = 10\text{ ms}$	$f = 50\text{ Hz}$	0.32	A^2s
		$t_p = 8.3\text{ ms}$	$f = 60\text{ Hz}$	0.41	
di/dt	Critical Rate of Rise of On-state Current $I_G = 10\text{ mA}$	TO-92 SOT-89 SOT-223	$T_J = 125\text{ }^\circ\text{C}$	50	$\text{A}/\mu\text{s}$
I_{GM}	Peak Gate Current	$t_p = 10\text{ }\mu\text{s}$	$T_J = 125\text{ }^\circ\text{C}$	1.0	A
$P_{G(AV)}$	Average Gate Power Dissipation	-	$T_J = 125\text{ }^\circ\text{C}$	0.1	W
T_{STG}	Storage Junction Temperature Range	-	-	-40 to 150	$^\circ\text{C}$
T_J	Operating Junction Temperature Range	-	-	-40 to 125	$^\circ\text{C}$

2. Thermal Characteristics

Symbol	Characteristic	Conditions	Value	Unit	
$R_{th(JC)}$	Thermal Resistance, junction-to-case (AC)	$I_T = 0.8\text{ A}_{(RMS)}^1$	TO-92	75	$^\circ\text{C}/\text{W}$
			SOT-223	30	
			SOT-89	50	
$R_{th(JA)}$	Thermal Resistance, junction-to-ambient	$I_T = 0.8\text{ A}_{(RMS)}^1$	TO-92	150	$^\circ\text{C}/\text{W}$
			SOT-223	60	
			SOT-89	90	

Note 1: 60 Hz AC resistive load condition, 100% conduction

3. Electrical Characteristics ($T_J = 25\text{ }^\circ\text{C}$ unless otherwise specified)

Symbol	Description	Conditions	SxX8yS1			SxX8yS2			SxX8yS			Unit
			Min	Typ	Max	Min	Typ	Max	Min	Typ	Max	
I_{GT}	DC Gate Trigger Current	$V_D = 6\text{ V}, R_L = 100\text{ }\Omega$	0.5	-	5	1	-	50	15	-	200	μA
V_{GT}	DC Gate Trigger Voltage	$V_D = 6\text{ V}, R_L = 100\text{ }\Omega$	-	-	0.8	-	-	0.8	-	-	0.8	V
V_{GRM}	Peak Reverse Gate Voltage	$I_{RG} = 10\text{ }\mu\text{A}$	5	-	-	5	-	-	5	-	-	V
I_H	Holding Current	$R_{GK} = 1\text{ k}\Omega$, Initial current = 20 A	-	-	5	-	-	5	-	-	5	mA
$(dv/dt)_s$	Critical Rate-of-rise of Off-stage Voltage	$T_J = 125\text{ }^\circ\text{C}, V_D = V_{DRM}/V_{RRM}$, $R_{GK} = 1\text{ k}\Omega$, Exponential waveform	75	-	-	75	-	-	75	-	-	$\text{V}/\mu\text{s}$
t_q	Turn-off Time	$T_J = 25\text{ }^\circ\text{C} @ 600\text{ V}, R_{GK} = 1\text{ k}\Omega$	-	-	30	-	-	25	-	-	25	μs
t_{gt}	Turn-on Time	$I_G = 10\text{ mA}, P_W = 15\text{ }\mu\text{s}, I_T = 1.6\text{ A}_{PK}$	-	2	-	-	2	-	-	2	-	μs
V_{GD}	Gate Non-trigger Voltage	$V_D = V_{DRM}, R_{GK} = 1\text{ k}\Omega, T_J = 125\text{ }^\circ\text{C}$	0.2	-	-	0.2	-	-	0.2	-	-	V

Note: x = voltage /100, y = package

4. Static Characteristics ($T_J = 25\text{ }^\circ\text{C}$ unless otherwise specified)

Symbol	Description	Conditions	Value		Unit
			Min	Max	
V_{TM}	Peak On-state Voltage	$I_{TM} = 1.6\text{ A}_{PK}$	-	1.70	V
I_{DRM}	Off-state Current, Peak Repetitive	$T_J = 25\text{ }^\circ\text{C} @ V_D = V_{DRM}, R_{GK} = 1\text{ k}\Omega$	-	3	μA
		$T_J = 125\text{ }^\circ\text{C} @ V_D = V_{DRM}, R_{GK} = 1\text{ k}\Omega$	-	500	

5. Performance Curves

Figure 1. Normalized DC Gate Trigger Current for All Quadrants vs. Junction Temperature

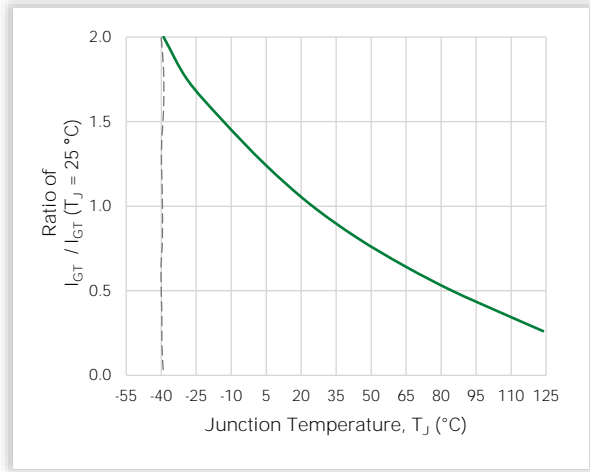

Figure 2. Normalized DC Holding Current vs. Junction Temperature

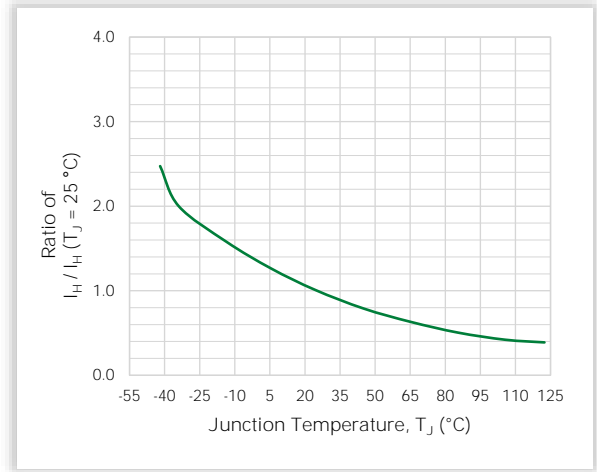

Figure 3. Normalized DC Gate Trigger Voltage vs. Junction Temperature

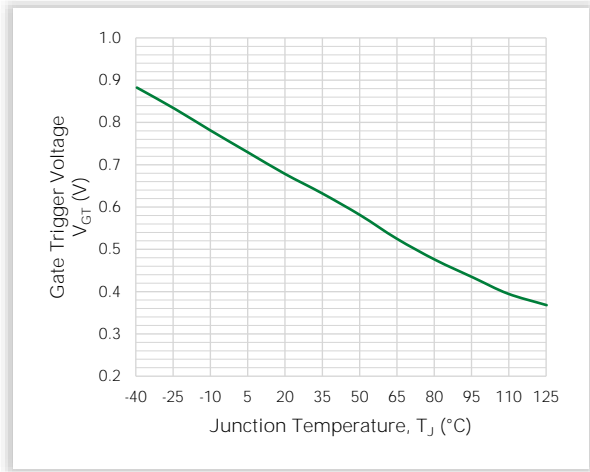

Figure 4. Typical On-state Current vs. On-state Voltage

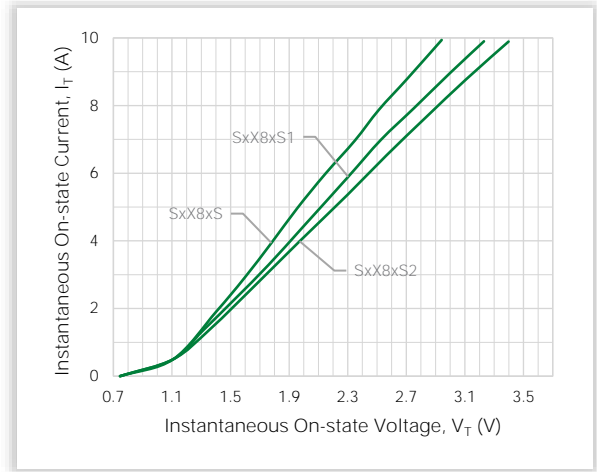

Figure 5. Typical Power Dissipation vs. RMS On-state Current

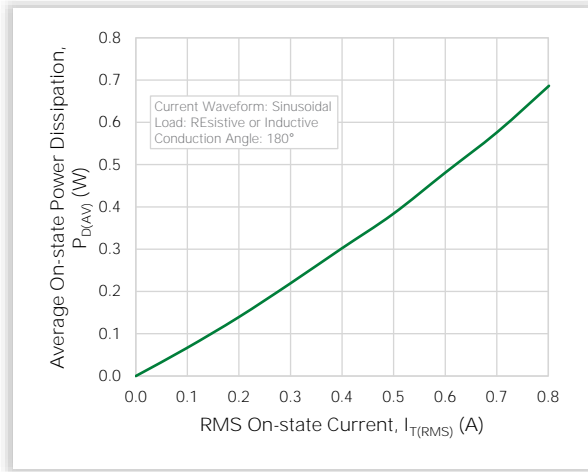

Figure 6. Maximum Allowable Case Temperature vs. On-state Current

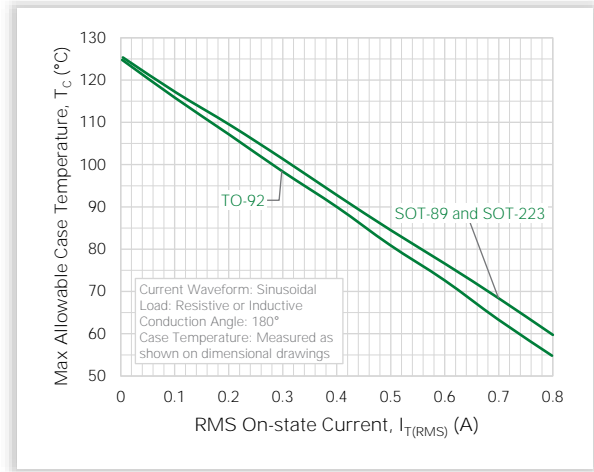

Figure 7. Typical DC Gate Trigger Current with R_{GK} vs. Junction Temperature for S6X8xS

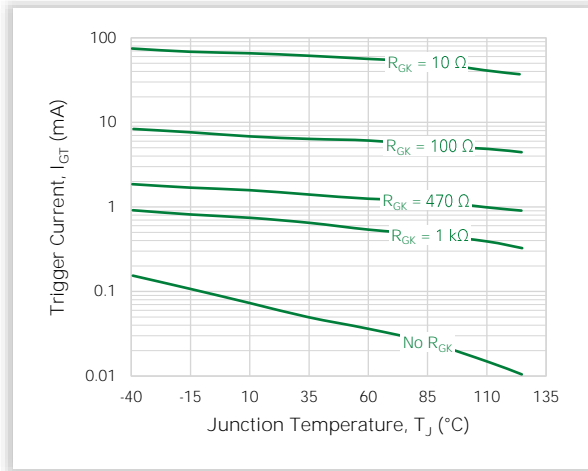

Figure 8. Typical DC Gate Trigger Current with R_{GK} vs. Junction Temperature for S8X8xS

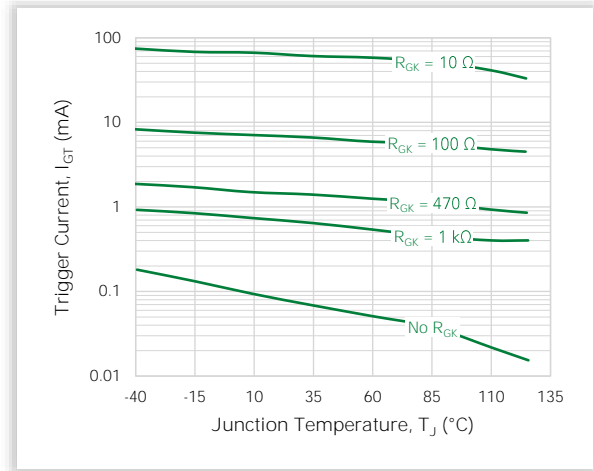

Figure 9. Typical DC Holding Current with R_{GK} vs. Junction Temperature for S6X8xS

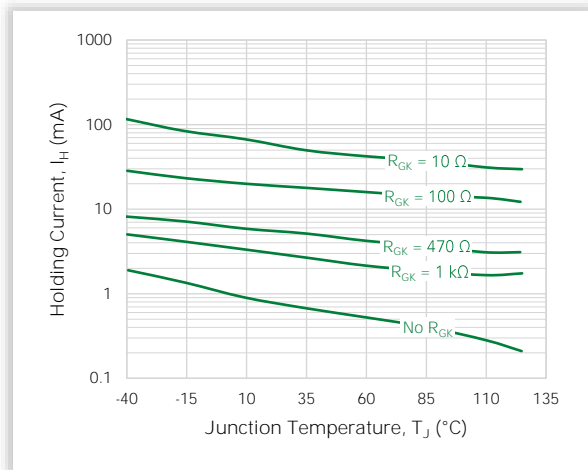

Figure 10. Typical DC Holding Current with R_{GK} vs. Junction Temperature for S8X8xS

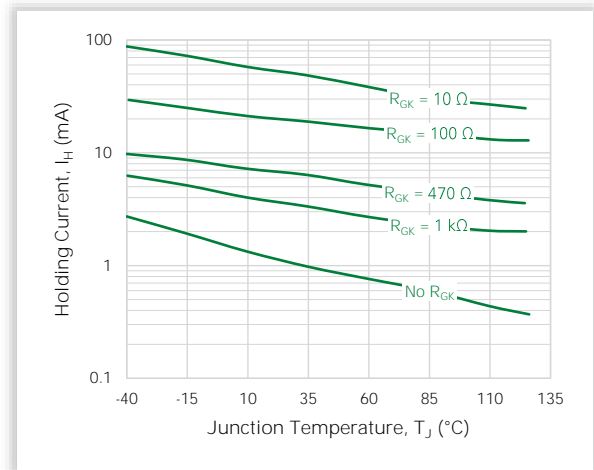

Figure 11. Typical DC Static dv/dt with R_{GK} vs. Junction Temperature for S6X8xS

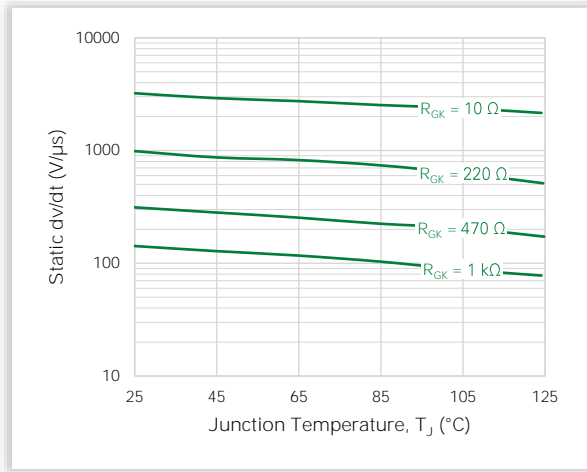

Figure 12. Typical DC Static dv/dt with R_{GK} vs. Junction Temperature for S8X8xS

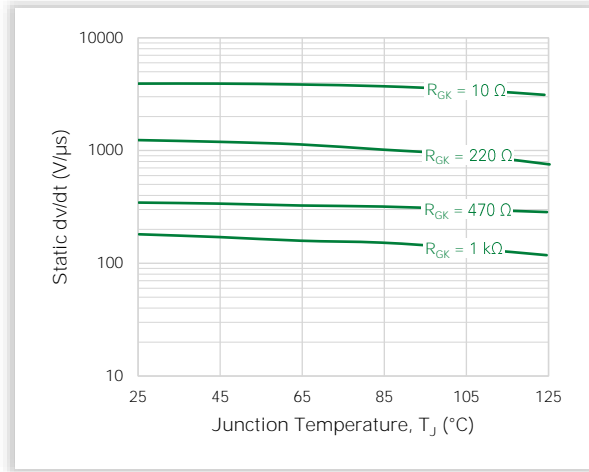

Figure 13. Typical DC Turn-off Time with R_{GK} vs. Junction Temperature for S6X8xS

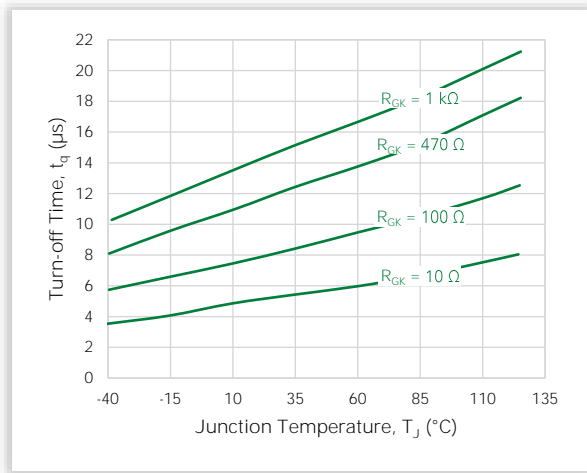

Figure 14. Typical DC Turn-off Time with R_{GK} vs. Junction Temperature for S8X8xS

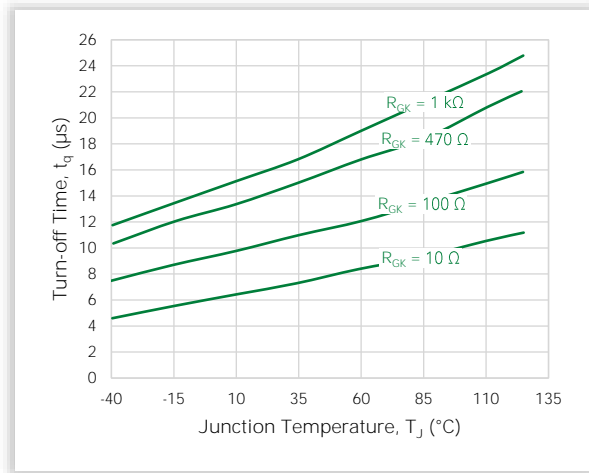
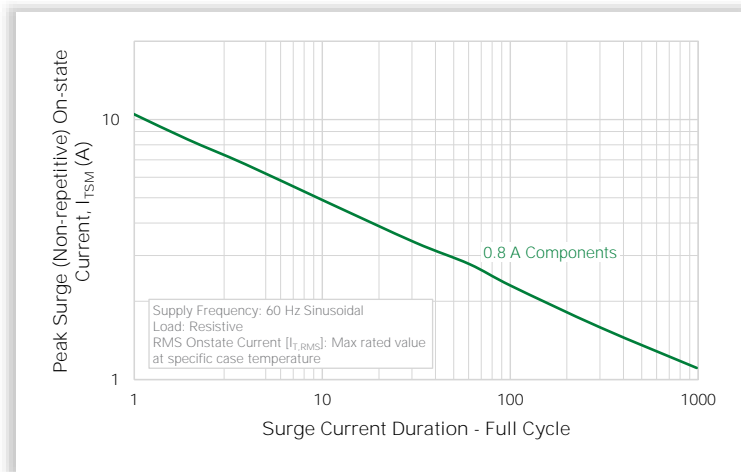

Figure 15. Surge Peak On-state Current vs. Number of Cycles



Notes

1. Gate control may be lost during and immediately following surge current interval.
2. Overload may not be repeated until junction temperature has returned to steady-state rated value.

Figure 16. Peak Repetitive Sinusoidal Pulse Current

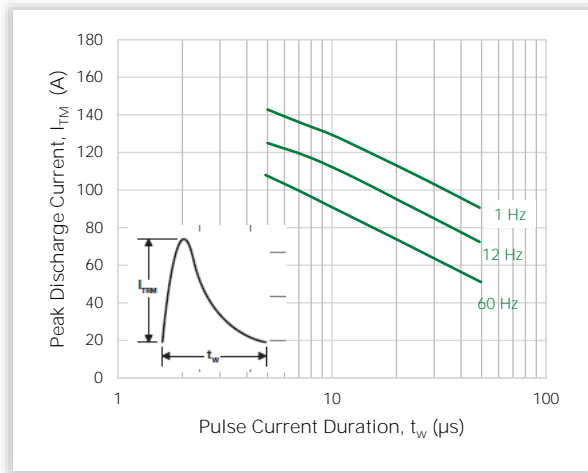

6. Soldering Parameters

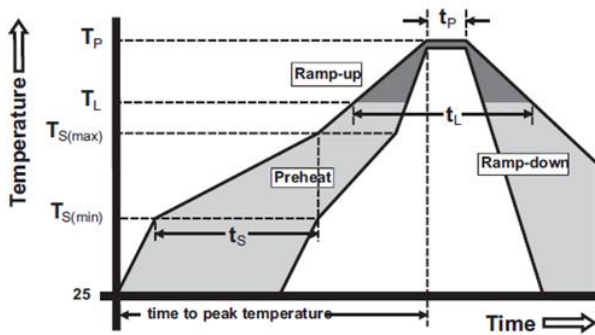

Parameter	Value	
Reflow Condition	Pb-free Assembly	
Pre-Heat	Temperature Min, T _{S(Min)}	150 °C
	Temperature Max, T _{S(Max)}	200 °C
	Time (Min to Max), t _s	60 to 180 s
Average Ramp-up Rate Liquidus Temp., T _L to peak	5 °C/s (Max)	
T _{S(Max)} to T _L Ramp-up Rate	5 °C/s (Max)	
Reflow	Temperature, T _L Liquidus	217 °C
	Time, t _s	60 to 150 s
Peak Temperature, T _P	260 °C (±5 °C)	
Time within 5 °C of Actual Peak Temperature, t _P	20 to 40 s	
Ramp-down Rate	5 °C/s (Max)	
Time 25 °C to Peak Temperature, T _P	8 minutes (Max)	
Do Not Exceed	280 °C	

7. Physical Specifications

Device Feature	Detail
Terminal Finish	100% Matte Tin-plated
Body Material	UL Recognized Compound meeting Flammability Rating V-0
Lead Material	Copper Alloy

8. Environmental Specifications

Test	Specifications and Conditions
AC Blocking	MIL-STD-750, M-1040, Cond A Applied Peak AC voltage @ 110°C for 1008 hours
Temperature Cycling	MIL-STD-750, M-1051, 100 cycles: -40°C to +150°C; 15 min dwell time
Temperature/Humidity	EIA / JEDEC, JESD22-A101 1008 hours; 320V - DC; 85°C; 85% relative humidity
High-temp Storage	MIL-STD-750, M-1031, 1008 hours, 150°C
Low-temp Storage	1008 hours, -40°C
Resistance to Solder Heat	MIL-STD-750 Method 2031
Solderability	ANSI/J-STD-002, category 3, Test A
Lead Bend	MIL-STD-750, M-2036 Cond E

9. Design Considerations

Careful selection of the correct component for the application's operating parameters and environment will go a long way toward extending the operating life of the Thyristor. Good design practice should limit the maximum continuous current through the main terminals to 75% of the component rating. Other ways to ensure long life for a power discrete semiconductor are proper heat sinking and selection of voltage ratings for worst case conditions. Overheating, overvoltage (including dv/dt), and surge currents are the main killers of semiconductors. Correct mounting, soldering, and forming of the leads also help protect against component damage.

10. Package Dimensions

TO-92

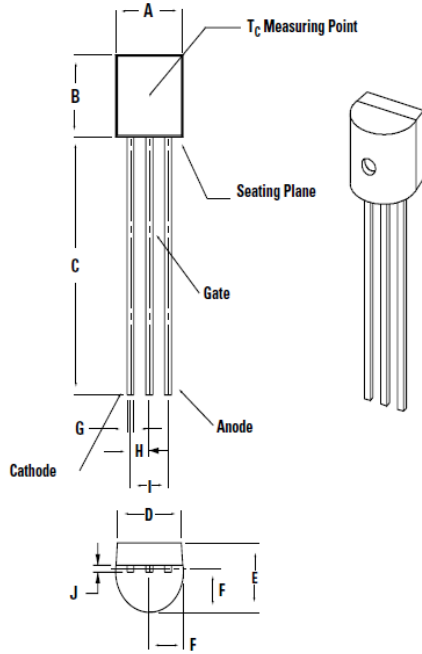

Dimension	Millimeters		Inches	
	Min	Max	Min	Max
A	4.450	5.200	0.175	0.205
B	4.320	5.330	0.170	0.210
C	12.700	-	0.500	-
D	3.430	-	0.135	-
E	3.180	4.190	0.125	0.165
F	2.040	2.660	0.080	0.105
G	0.407	0.533	0.016	0.021
H	1.150	1.390	0.045	0.055
I	2.420	2.660	0.095	0.105
J	0.380	0.500	0.015	0.020

SOT-223

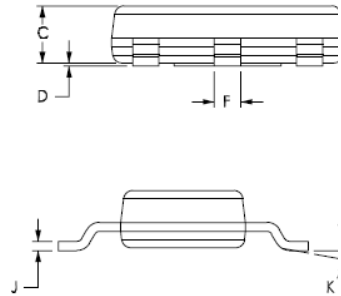
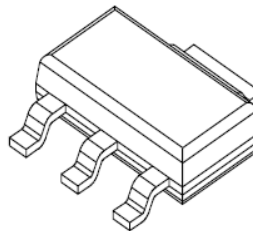
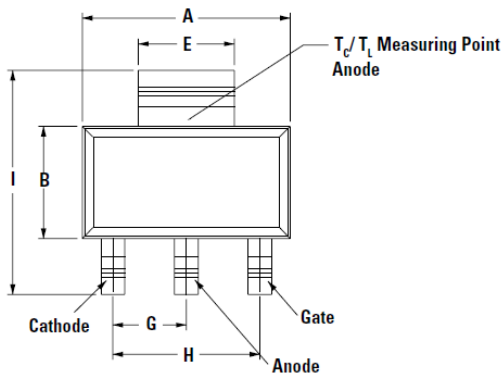

Pad Layout for SOT-223

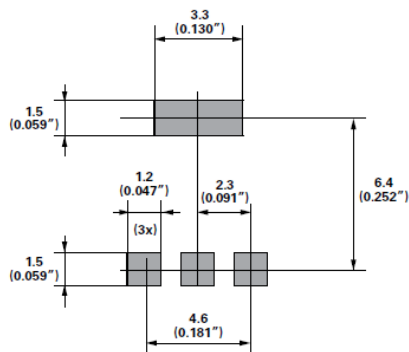

*Dimensions in millimeters (inches)

Dimension	Millimeters			Inches		
	Min	Typ	Max	Min	Typ	Max
A	6.30	6.50	6.70	0.248	0.256	0.264
B	3.30	3.50	3.70	0.130	0.138	0.146
C	-	-	1.80	-	-	0.071
D	0.02	-	0.10	0.001	-	0.004
E	2.90	3.00	3.15	0.114	0.118	0.124
F	0.60	0.70	0.85	0.024	0.027	0.034
G	-	2.30	-	-	0.090	-
H	-	4.60	-	-	0.181	-
I	6.70	7.00	7.30	0.264	0.276	0.287
J	0.24	0.26	0.35	0.009	0.010	0.014
K	10° MAX					

SOT-89

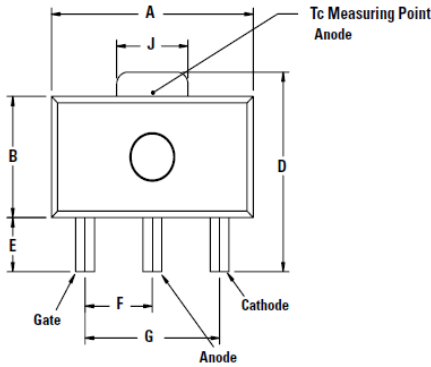

Pad Layout for SOT-89

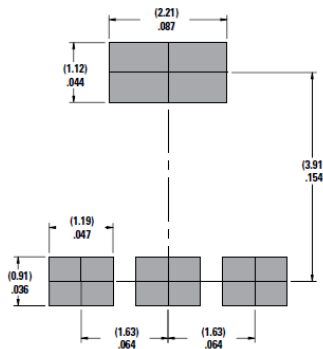

* Dimensions in millimeters (inches)

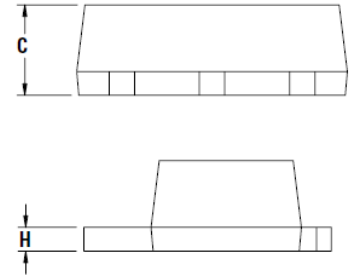
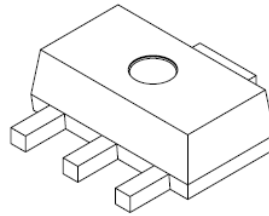

Dimension	Millimeters			Inches		
	Min	Typ	Max	Min	Typ	Max
A	4.40	-	4.60	0.173	-	0.181
B	2.29	-	2.60	0.090	-	0.102
C	1.40	-	1.60	0.055	-	0.063
D	3.94	-	4.25	0.155	-	0.167
E	0.81	-	1.20	0.032	-	0.047
F	-	1.50	-	-	0.059	-
G	-	3	-	-	0.118	-
H	0.35	-	0.44	0.014	-	0.017
I	0.36	-	0.48	0.014	-	0.019
J	-	1.65	-	-	0.065	-

11. Part Numbering and Marking

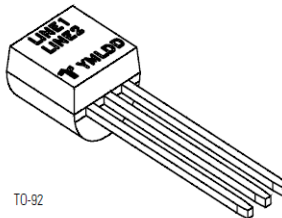
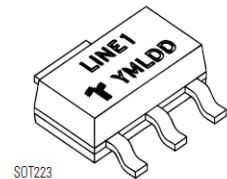
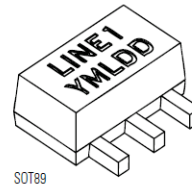
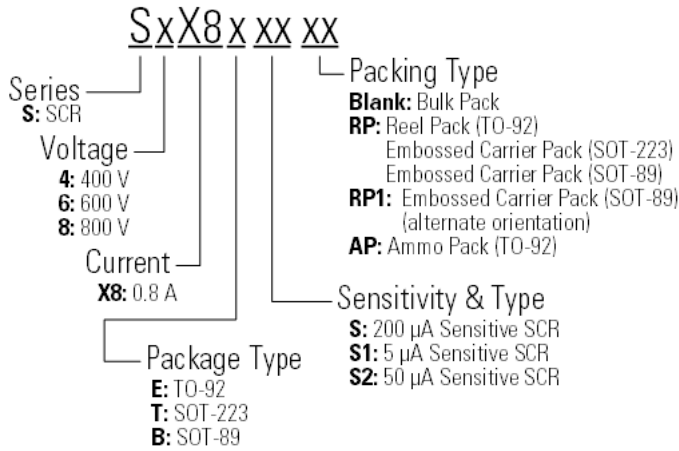

Line 1 = Littelfuse Part Number
 Line 2 = continuation... Littelfuse Part Number
 Y = Last Digit of Calendar Year
 M = Letter Month Code (A-L for Jan-Dec)
 L = Location Code
 DD = Calendar Date

12. Product Selector

Part Number	Voltage			Gate Sensitivity	Package
	400 V	600 V	800 V		
SxX8BS	X	X	-	200 μ A	SOT-89
SxX8ES	X	X	X	200 μ A	TO-92
SxX8TS	X	X	X	200 μ A	SOT-223
SxX8BS1	X	X	-	5 μ A	SOT-89
SxX8ES1	X	X	X	5 μ A	TO-92
SxX8TS1	X	X	X	5 μ A	SOT-223
SxX8BS2	X	X	-	50 μ A	SOT-89
SxX8ES2	X	X	X	50 μ A	TO-92
SxX8TS2	X	X	X	50 μ A	SOT-223

13. Packing Options

Part Number	Marking	Weight	Packing Mode	Base Quantity
SxX8ESy	SxX8ESy	0.217 g	Bulk	2500
SxX8ESyAP	SxX8ESy	0.217 g	Ammo Pack	2000
SxX8ESyRP	SxX8ESy	0.217 g	Tape & Reel	2000
SxX8TSyRP	SxX8TSy	0.120 g	Tape & Reel	1000
SxX8BSyRP	xX8y	0.053 g	Tape & Reel	1000
SxX8BSyRP1	xX8y	0.053 g	Tape & Reel	1000

Note: x = voltage/100, y = gate sensitivity

14. Packing Specifications

TO-92 (3-lead) Reel Pack (RP) Radial Leaded Specifications

Meets all EIA-468-C Standards

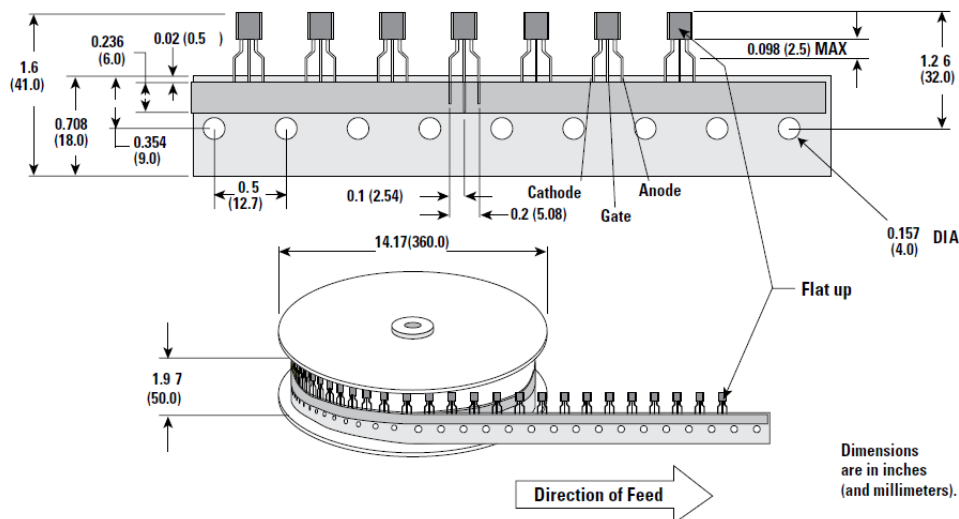

Dimensions are in inches (and millimeters).

TO-92 (3-lead) Ammo Pack (AP) Radial Leaded Specifications

Meets all EIA-468-C Standards

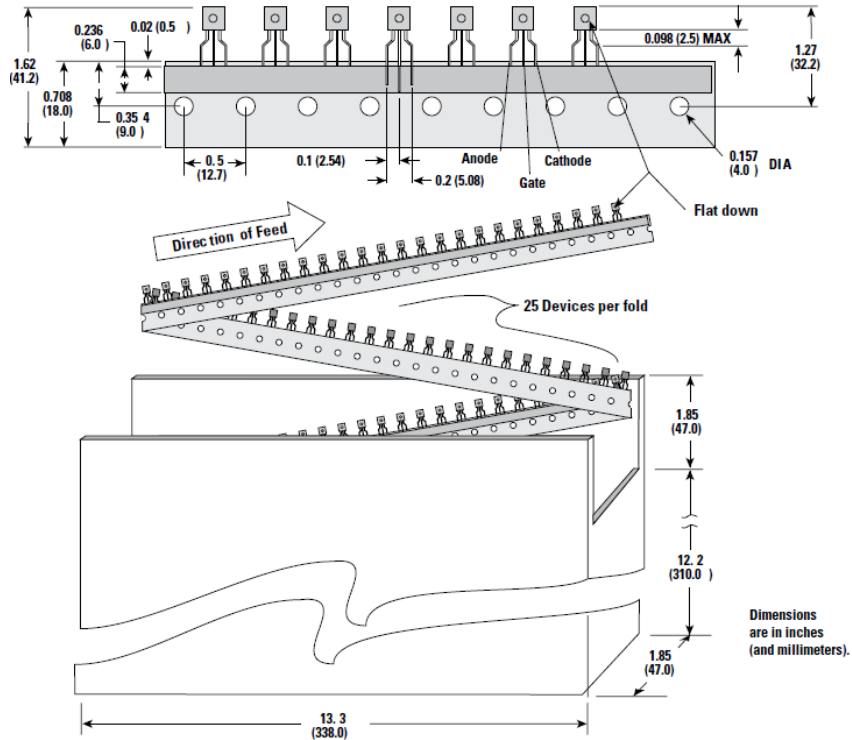

SOT-89 Reel Pack (RP) Specifications

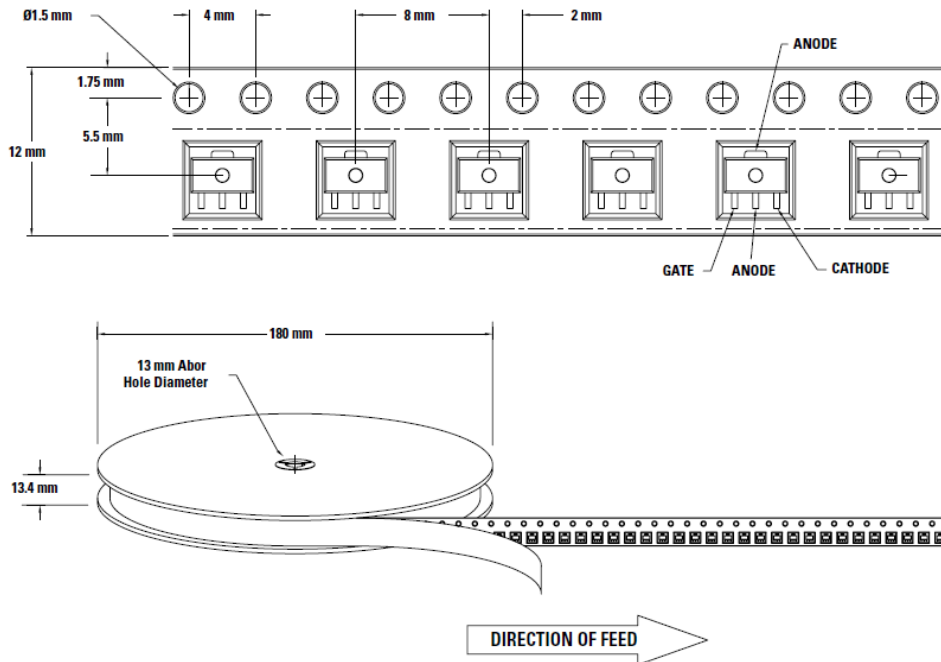

SOT-89 Reel Pack (RP1) Specifications

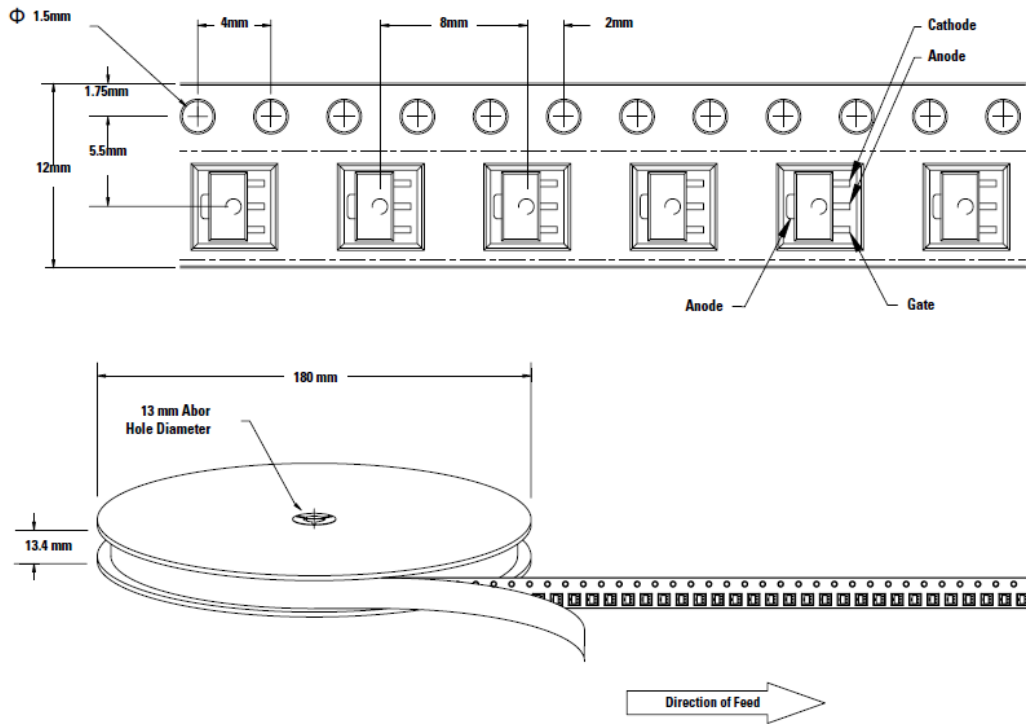

SOT-223 Reel Pack (RP) Specifications

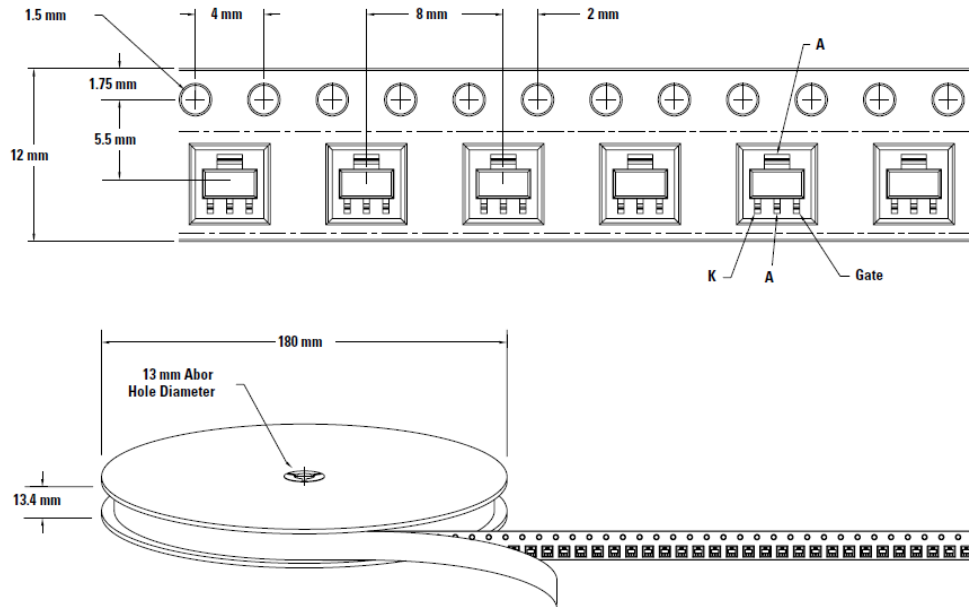

For additional information please visit www.Littelfuse.com/powersemi

Disclaimer Notice - Littelfuse products are not designed for, and shall not be used for, any purpose (including, without limitation, automotive, military, aerospace, medical, life-saving, life-sustaining or nuclear facility applications, devices intended for surgical implant into the body, or any other application in which the failure or lack of desired operation of the product may result in personal injury, death, or property damage) other than those expressly forth in applicable Littelfuse product documentation. Littelfuse shall not be liable for any claims or damages arising out of products used in applications not expressly intended by Littelfuse as set forth in applicable Littelfuse documentation.

Read complete Disclaimer Notice at www.littelfuse.com/disclaimer-electronics

X-ON Electronics

Largest Supplier of Electrical and Electronic Components

Click to view similar products for [SCRs category](#):

Click to view products by [Littelfuse manufacturer](#):

Other Similar products are found below :

[NTE5428](#) [T1500N16TOF VT](#) [T720N18TOF](#) [T880N16TOF](#) [TT162N16KOF-A](#) [TT330N16AOF](#) [VS-16RIA100](#) [VS-22RIA20](#) [VS-2N685](#)
[057219R](#) [T1190N16TOF VT](#) [T1220N22TOF VT](#) [T201N70TOH](#) [T830N14TOF](#) [TT250N12KOF-K](#) [VS-110RKI40](#) [NTE5427](#) [T2160N28TOF](#)
[VT](#) [VS-22RIA100](#) [VS-16RIA40](#) [VS-ST110S16P0](#) [T2160N24TOF VT](#) [T1190N18TOF VT](#) [T1590N28TOF VT](#) [2N1776A](#) [T590N14TOF](#)
[NTE5375](#) [NTE5460](#) [NTE5481](#) [NTE5504](#) [NTE5512](#) [NTE5514](#) [NTE5518](#) [NTE5519](#) [NTE5529](#) [NTE5553](#) [NTE5555](#) [NTE5557](#) [NTE5567](#)
[NTE5570](#) [NTE5572](#) [NTE5574](#) [NTE5576](#) [NTE5579](#) [NTE5589](#) [NTE5592](#) [NTE5598](#) [NTE6418](#) [T690N06TOF](#) [VS-22RIA80](#)