

## S6002xS Series

### EV Series 2 A Sensitive SCRs

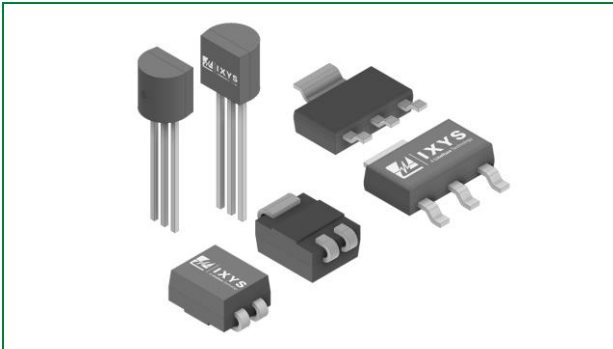

### Agency Approvals and Environmental

Environmental Approvals



### Schematic Symbol

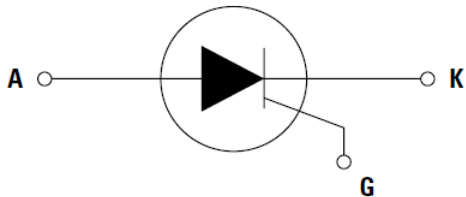

### Product Summary

Characteristic	Value	Unit
$I_{T(RMS)}$	2	A
$V_{DRM} / V_{RRM}$	600	V
$I_{GT}$	200	$\mu A$

### Product Description

The S6002xS offers high very high di/dt capability through small die planar construction design. It is glass-passivated to ensure long term reliability and parametric stability.

### Features

- Surge capability > 25 A
- Blocking voltage ( $V_{DRM}/V_{RRM}$ ) capability – up to 600 V
- High di/dt capability of 500 A/ $\mu s$
- Improved turn-off time ( $t_q$ ) < 55  $\mu s$
- Sensitive gate for direct microprocessor interface
- Thru hole and surface mount packages
- RoHS compliant and Halogen-free

### Applications

- The S6002xS is specifically designed for capacitor discharge application such as high-power gas flame ignition.

- 1. Maximum Ratings.....3
- 2. Thermal Characteristics .....3
- 3. Electrical Characteristics ( $T_J = 25\text{ }^\circ\text{C}$  unless otherwise specified) .....3
- 4. Static Characteristics ( $T_J = 25\text{ }^\circ\text{C}$  unless otherwise specified).....3
- 5. Performance Curves .....4
- 6. Soldering Parameters .....6
- 7. Physical Specifications.....6
- 8. Environmental Specifications.....6
- 9. Design Considerations.....6
- 10. Package Dimensions .....7
- 11. Part Numbering and Marking.....8
- 12. Product Selector .....9
- 13. Packing Options.....9
- 14. Packing Specifications .....9

## 1. Maximum Ratings

Symbol	Characteristic	Conditions		Value	Unit
$I_{T(RMS)}$	RMS On-state Current (Full Sine Wave)	TO-92	$T_C = 65\text{ }^\circ\text{C}$	2	A
		SOT-223 & Compak	$T_C = 95\text{ }^\circ\text{C}$		
$I_{T(AV)}$	Average On-state Current	TO-92	$T_C = 65\text{ }^\circ\text{C}$	1.2	A
		SOT-223 & Compak	$T_C = 95\text{ }^\circ\text{C}$		
$I_{TSM}$	Non-repetitive Surge Peak On-state Current (Full Cycle, $T_J$ Initial = $25\text{ }^\circ\text{C}$ )	TO-92 SOT-223 Compak	$f = 50\text{ Hz}$	22.5	A
			$f = 60\text{ Hz}$	25.0	
$I^2t$	$I^2t$ Value for Fusing		$f = 50\text{ Hz}$ , $t_p = 10\text{ ms}$	2.5	$\text{A}^2\text{s}$
$di/dt$	Critical Rate of Rise of On-state Current $I_G = 10\text{ mA}$	TO-92 SOT-223 Compak	$T_J = 25\text{ }^\circ\text{C}$	500	$\text{A}/\mu\text{s}$
$I_{GM}$	Peak Gate Current		$t_p = 20\text{ }\mu\text{s}$ , $T_J = 125\text{ }^\circ\text{C}$	1.0	A
$P_{G(AV)}$	Average Gate Power Dissipation		$T_J = 125\text{ }^\circ\text{C}$	0.2	W
$T_{STG}$	Storage Junction Temperature			-40 to 150	$^\circ\text{C}$
$T_J$	Operating Junction Temperature			-40 to 125	$^\circ\text{C}$

## 2. Thermal Characteristics

Symbol	Characteristic		Value	Unit	
$R_{th(JC)}$	Thermal Resistance, junction-to-case (AC)	$I_T = 1.5\text{ A}_{(RMS)}$ <sup>1</sup>	TO-92	30	$^\circ\text{C}/\text{W}$
			SOT-223 & Compak	15	
$R_{th(JA)}$	Thermal Resistance, junction-to-ambient (AC)	$I_T = 1.5\text{ A}_{(RMS)}$ <sup>1</sup>	TO-92	160	$^\circ\text{C}/\text{W}$
			SOT-223 & Compak	60	

## 3. Electrical Characteristics ( $T_J = 25\text{ }^\circ\text{C}$ unless otherwise specified)

Symbol	Description	Conditions	Value		Unit
			Min	Max	
$I_{GT}$	DC Gate Trigger Current	$V_D = 6\text{ V}$ , $R_L = 100\text{ }\Omega$	20	200	$\mu\text{A}$
$V_{GT}$	DC Gate Trigger Voltage	$V_D = 6\text{ V}$ , $R_L = 100\text{ }\Omega$	-	0.8	V
$V_{GRM}$	Peak Reverse Gate Voltage	$I_{RG} = 10\text{ }\mu\text{A}$	5	-	V
$I_H$	Holding Current	$R_{GK} = 1\text{ k}\Omega$	-	5	mA
$V_{GD}$	Gate Non-trigger Voltage	$V_D = V_{DRM}$ , $R_{GK} = 1\text{ k}\Omega$ , $T_J = 125\text{ }^\circ\text{C}$	0.2	-	V
$dv/dt$	Critical Rate-of-rise of Off-stage Voltage	$T_J = 125\text{ }^\circ\text{C}$ , $V_D = 67\% V_{DRM}$ , Exponential Waveform, $R_{GK} = 1\text{ k}\Omega$	25	-	$\text{V}/\mu\text{s}$
$t_q$	Turn-off Time	$I_T = 0.5\text{ A}$	-	55	$\mu\text{s}$
$t_{gt}$	Turn-on Time	$I_G = 10\text{ mA}$ , $P_W = 15\text{ }\mu\text{sec}$ , $I_T = 3.0\text{ A}_{(PK)}$	-	-	$\mu\text{s}$

## 4. Static Characteristics ( $T_J = 25\text{ }^\circ\text{C}$ unless otherwise specified)

Symbol	Description	Conditions	Value		Unit
			Min	Max	
$V_{TM}$	Peak On-state Voltage	$I_{TM} = 3\text{ A}_{(PK)}$ , $t_p = 380\text{ }\mu\text{s}$	-	1.5	V
$I_{DRM}/I_{RRM}$	Off-state Current, Peak Repetitive	$T_J = 25\text{ }^\circ\text{C}$ @ $V_D = V_{DRM}$ , $R_{GK} = 1\text{ k}\Omega$	-	5	$\mu\text{A}$
		$T_J = 125\text{ }^\circ\text{C}$ @ $V_D = V_{DRM}$ , $R_{GK} = 1\text{ k}\Omega$	-	500	$\mu\text{A}$

### 5. Performance Curves

Figure 1. Normalized DC Gate Trigger Current vs. Junction Temperature

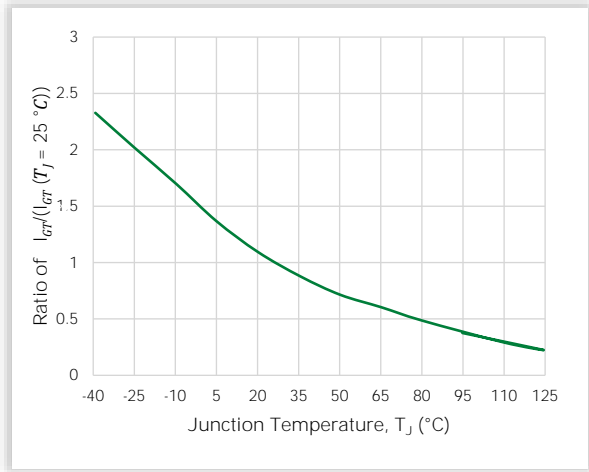

Figure 2. Normalized DC Gate Trigger Voltage vs. Junction Temperature

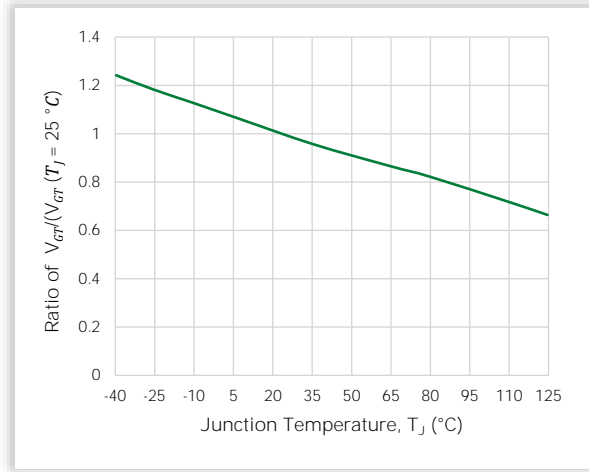

Figure 3. Normalized DC Holding Current vs. Junction Temperature

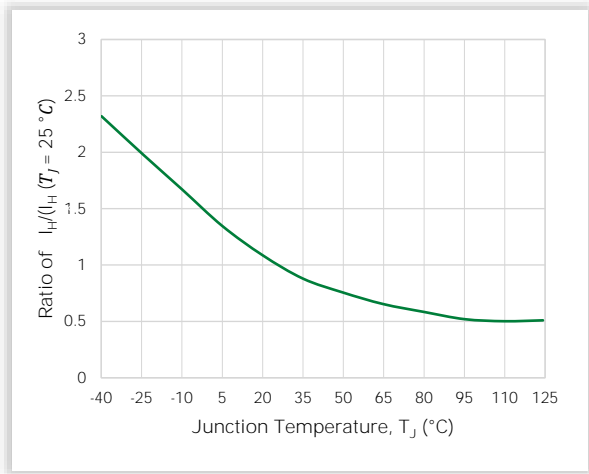

Figure 4. Typical On-state Current vs. On-state Voltage

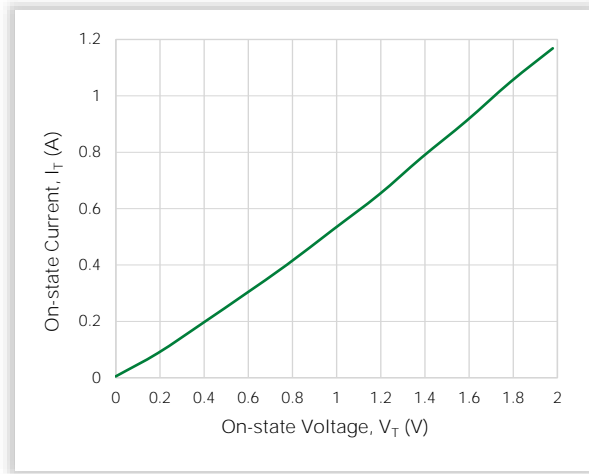

Figure 5. Typical Power Dissipation vs. RMS On-state Current

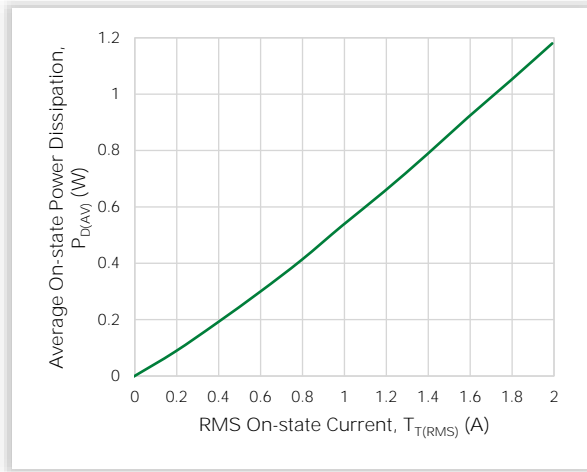

Figure 6. Maximum Allowable Case Temperature vs. RMS On-state Current

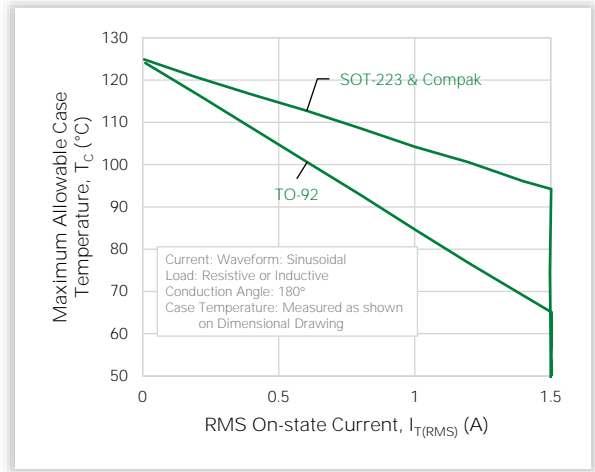
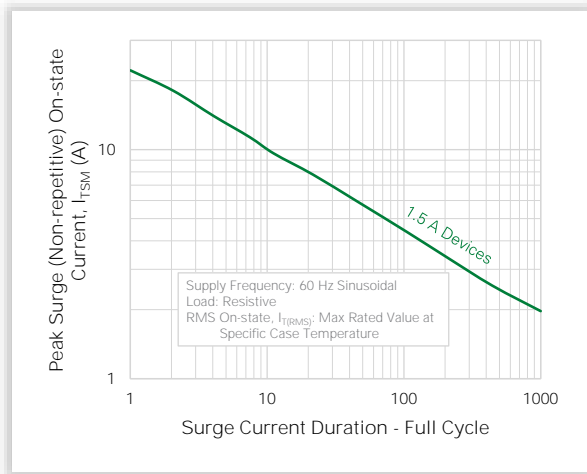

Figure 7. Surge Peak On-state Current vs. Number of Cycles



Notes:

1. Gate control may be lost during and immediately following surge current interval.
2. Overload may not be repeated until junction temperature has returned to steady-state rated value.

Figure 8. Peak Repetitive Capacitor Discharge Current

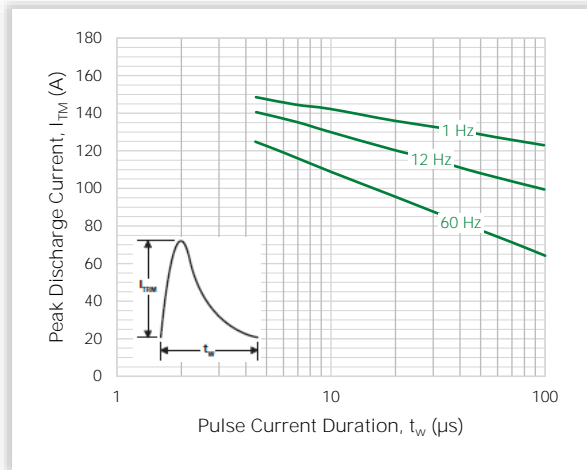
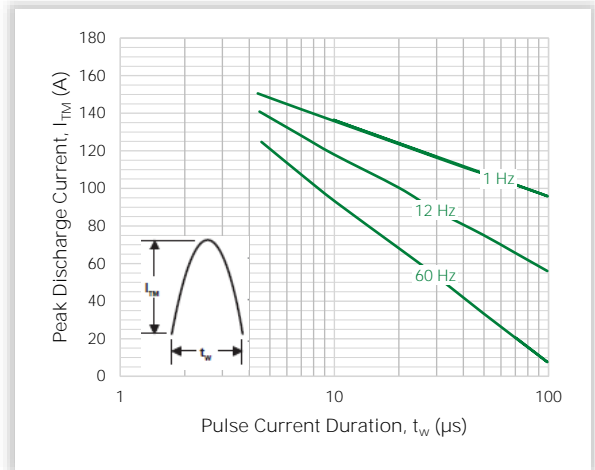
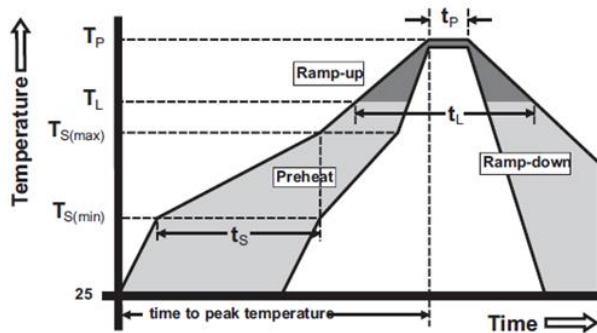

Figure 9. Peak Repetitive Sinusoidal Pulse Current



### 6. Soldering Parameters



Parameter	Value	
Reflow Condition	Pb-free Assembly	
Pre-Heat	Temperature Min, $T_{S(\text{Min})}$	150 °C
	Temperature Max, $T_{S(\text{Max})}$	200 °C
	Time (Min to Max), $t_s$	60 to 180 s
Average Ramp-up Rate Liquidus Temp., $T_L$ to peak	5 °C/s (Max)	
$T_{S(\text{Max})}$ to $T_L$ Ramp-up Rate	5 °C/s (Max)	
Reflow	Temperature, $T_L$ Liquidus	217 °C
	Time, $t_L$	60 to 150 s
Peak Temperature, $T_P$	260 °C ( $\pm 5$ °C)	
Time within 5 °C of Actual Peak Temperature, $t_p$	20 to 40 s	
Ramp-down Rate	5 °C/s (Max)	
Time 25 °C to Peak Temperature, $T_P$	8 minutes (Max)	
Do Not Exceed	280 °C	

### 7. Physical Specifications

Device Feature	Detail
Terminal Finish	100% Matte Tin-plated
Body Material	UL Recognized Epoxy meeting Flammability Rating 94 V-0
Terminal Material	Copper Alloy

### 9. Design Considerations

Careful selection of the correct component for the application's operating parameters and environment will go a long way toward extending the operating life of the Thyristor. Good design practice should limit the maximum continuous current through the main terminals to 75% of the component rating. Other ways to ensure long life for a power discrete semiconductor are proper heat sinking and selection of voltage ratings for worst case conditions. Overheating, overvoltage (including dv/dt), and surge currents are the main killers of semiconductors. Correct mounting, soldering, and forming of the leads also help protect against component damage.

### 8. Environmental Specifications

Test	Specifications and Conditions
AC Blocking	MIL-STD-750, M-1040, Cond A Applied Peak AC voltage @ 110°C for 1008 hours
Temperature Cycling	MIL-STD-750, M-1051, 100 cycles: -40°C to +150°C; 15 min dwell time
Temperature/Humidity	EIA / JEDEC, JESD22-A101 1008 hours; 320V - DC; 85°C; 85% relative humidity
High-temp Storage	MIL-STD-750, M-1031, 1008 hours; 150°C
Low-temp Storage	1008 hours; -40°C
Resistance to Solder Heat	MIL-STD-750 Method 2031
Solderability	ANSI/J-STD-002, category 3, Test A
Lead Bend	MIL-STD-750, M-2036 Cond E

### 10. Package Dimensions

#### TO-92 (E- Package)

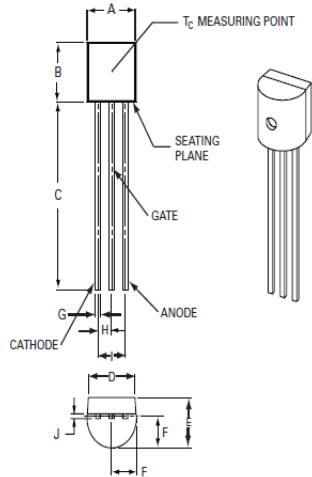

Dimension	Millimeters		Inches	
	Min	Max	Min	Max
A	4.450	5.200	0.175	0.205
B	4.320	5.330	0.170	0.210
C	12.700	-	0.500	-
D	3.430	-	0.135	-
E	3.180	4.190	0.125	0.165
F	2.040	2.660	0.080	0.105
G	0.407	0.533	0.016	0.021
H	1.150	1.390	0.045	0.055
I	2.420	2.660	0.095	0.105
J	0.380	0.500	0.015	0.020

#### SOT-223

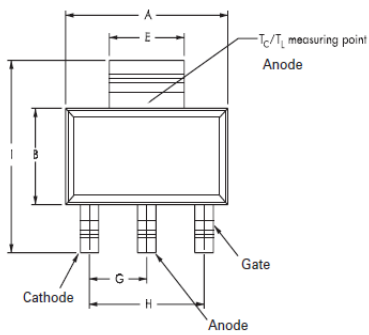

Pad Layout for SOT-223

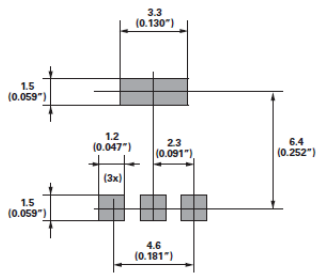

Dimensions in Millimeters (Inches)

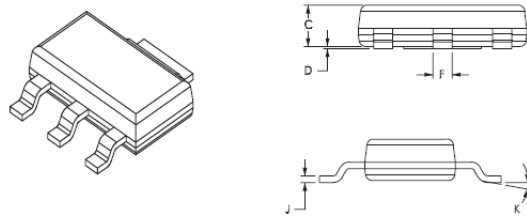

Dimension	Millimeters			Inches		
	Min	Typ	Max	Min	Typ	Max
A	6.30	6.50	6.70	0.248	0.256	0.264
B	3.30	3.50	3.70	0.130	0.138	0.146
C	-	-	1.80	-	-	0.071
D	0.02	-	0.10	0.001	-	0.004
E	2.90	3.00	3.15	0.114	0.118	0.124
F	0.60	0.70	0.85	0.024	0.027	0.034
G	-	2.30	-	-	0.090	-
H	-	4.60	-	-	0.181	-
I	6.70	7.00	7.30	0.264	0.276	0.287
J	0.24	0.26	0.35	0.009	0.010	0.014
K	10° Max					

Compak (C- Package)

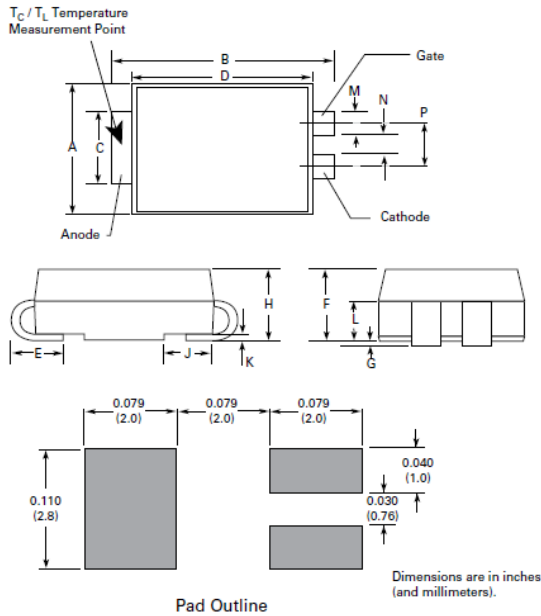

Dimension	Millimeters		Inches	
	Min	Max	Min	Max
A	3.30	3.95	0.130	0.156
B	5.10	5.60	0.201	0.220
C	1.95	2.20	0.077	0.087
D	4.05	4.60	0.159	0.181
E	0.75	1.60	0.030	0.063
F	1.90	2.45	0.075	0.096
G	0.05	0.20	0.002	0.008
H	1.95	2.65	0.077	0.104
J	1.09	1.35	0.043	0.053
K	0.15	0.41	0.006	0.016
L	0.76	1.40	0.030	0.055
M	0.56	0.71	0.022	0.028
N	0.69	0.84	0.027	0.033
P	1.32	1.47	0.052	0.058

11. Part Numbering and Marking

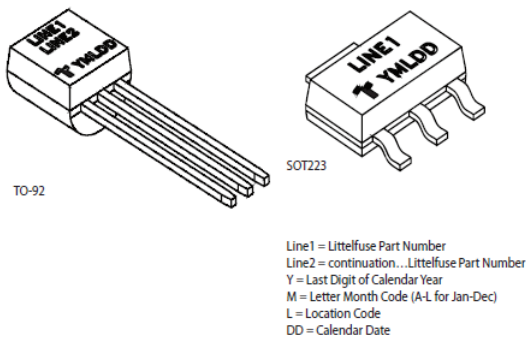
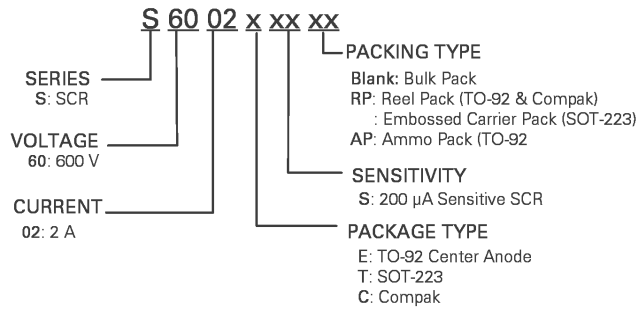

Compak (C Package)

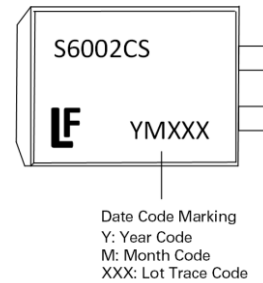



### 12. Product Selector

Part Number	Voltage	Gate Sensitivity	Package
	600 V		
S6002ES	X	200 $\mu$ A	TO-92
S6002TS	X	200 $\mu$ A	SOT-223
S6002CS	X	200 $\mu$ A	Compak

### 13. Packing Options

Part Number	Marking	Weight	Packing Mode	M.O.Q
S6002ES	S6002ES	0.217 g	Bulk	2500
S6002ESAP	S6002ES	0.217 g	Ammo Pack	2000
S6002ESRP	S6002ES	0.217 g	Tape & Reel	2000
S6002TSRP	S6002TS	0.120 g	Tape & Reel	1000
S6002CSR	S6002	0.120 g	Tape & Reel	2500

### 14. Packing Specifications

#### TO-92 (3-Lead) Reel Pack (RP) Radial Leaded Specifications

Meets all EIA-468-C Standards

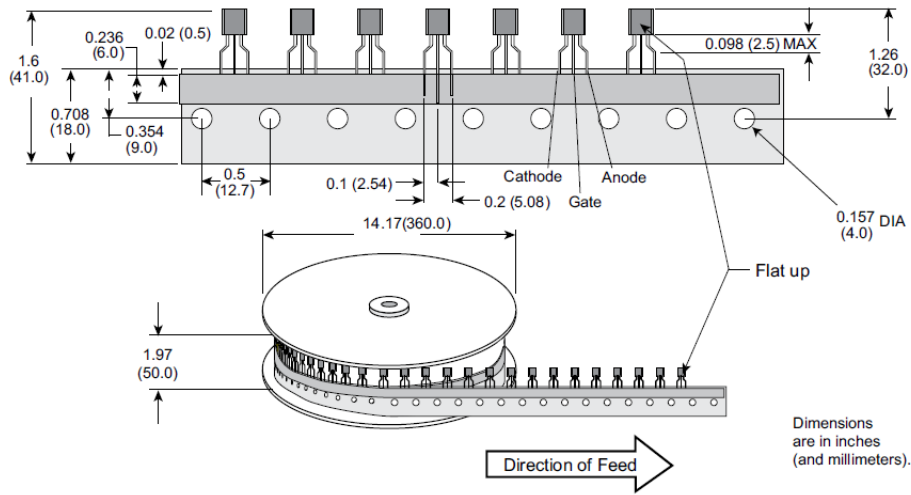

TO-92 (3-Lead) Ammo Pack (AP) Radial Leaded Specifications

Meets all EIA-468-C Standards

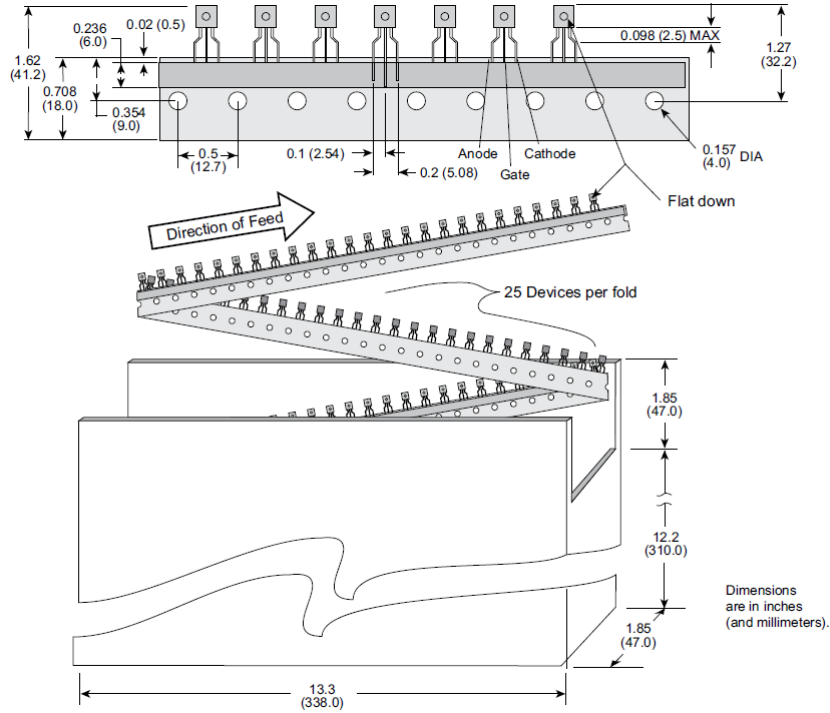

SOT-223 Reel Pack (RP) Specifications

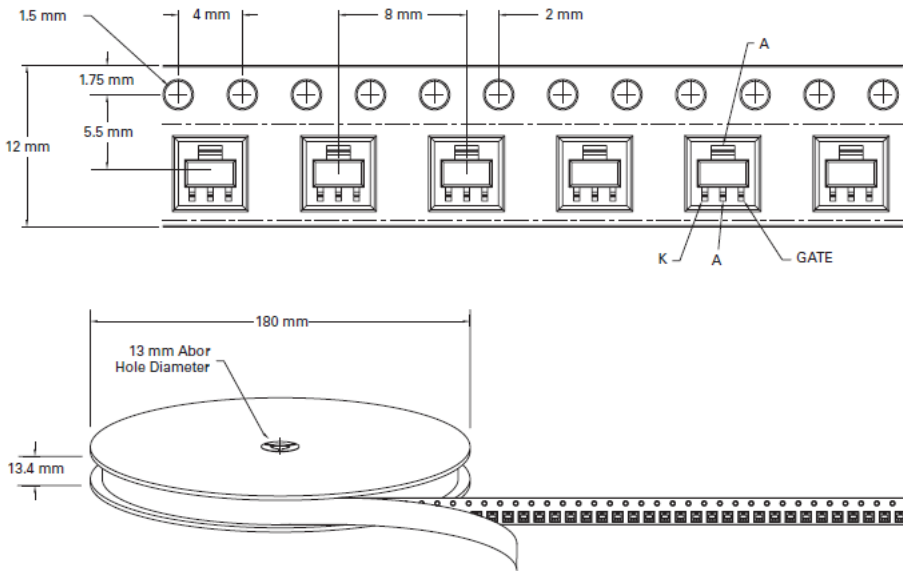

Compak Embossed Carrier Reel Pack (RP) Specifications

Meets all EIA-481-1 Standards

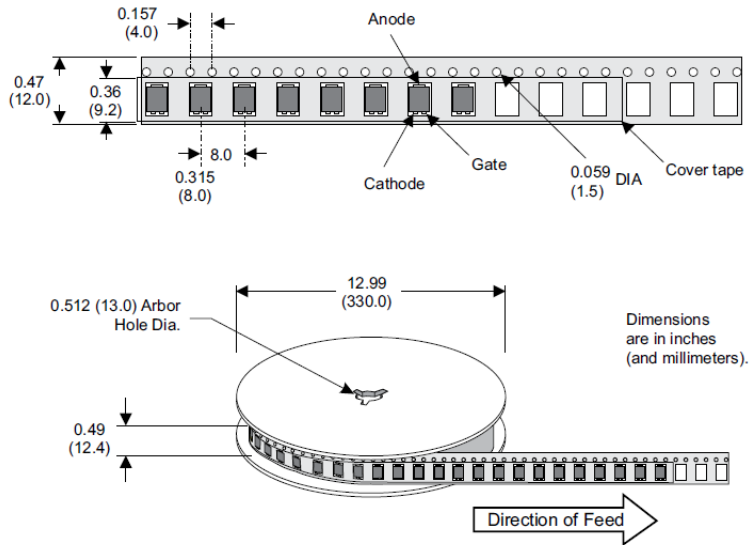

For additional information please visit [www.Littelfuse.com/powersemi](http://www.Littelfuse.com/powersemi)

Disclaimer Notice - Littelfuse products are not designed for, and shall not be used for, any purpose (including, without limitation, automotive, military, aerospace, medical, life-saving, life-sustaining or nuclear facility applications, devices intended for surgical implant into the body, or any other application in which the failure or lack of desired operation of the product may result in personal injury, death, or property damage) other than those expressly forth in applicable Littelfuse product documentation. Littelfuse shall not be liable for any claims or damages arising out of products used in applications not expressly intended by Littelfuse as set forth in applicable Littelfuse documentation.

Read complete Disclaimer Notice at [www.littelfuse.com/disclaimer-electronics](http://www.littelfuse.com/disclaimer-electronics)

## X-ON Electronics

Largest Supplier of Electrical and Electronic Components

*Click to view similar products for [SCRs category](#):*

*Click to view products by [Littelfuse manufacturer](#):*

Other Similar products are found below :

[NTE5428](#) [T1500N16TOF VT](#) [TT162N16KOF-A](#) [TT162N16KOF-K](#) [TT330N16AOF](#) [VS-22RIA20](#) [VS-2N685](#) [057219R](#) [T1190N16TOF VT](#)  
[T1220N22TOF VT](#) [T201N70TOH](#) [T700N22TOF](#) [T830N18TOF](#) [TT250N12KOF-K](#) [VS-16RIA120](#) [VS-110RKI40](#) [NTE5427](#) [NTE5442](#)  
[TT251N16KOF-K](#) [VS-22RIA100](#) [VS-16RIA40](#) [TD250N16KOF-A](#) [VS-ST110S16P0](#) [T930N36TOF VT](#) [T2160N24TOF VT](#) [T1190N18TOF](#)  
[VT](#) [T1590N28TOF VT](#) [2N1776A](#) [T590N14TOF](#) [NTE5375](#) [NTE5460](#) [NTE5481](#) [NTE5512](#) [NTE5514](#) [NTE5518](#) [NTE5519](#) [NTE5529](#)  
[NTE5553](#) [NTE5555](#) [NTE5557](#) [NTE5567](#) [NTE5570](#) [NTE5572](#) [NTE5574](#) [NTE5576](#) [NTE5578](#) [NTE5579](#) [NTE5589](#) [NTE5592](#) [NTE5598](#)