

Sxx65x & Sxx70x Series

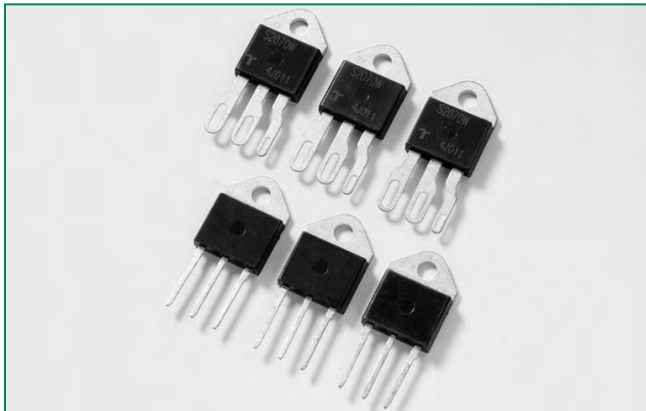

Description

Excellent unidirectional switches for phase control applications such as heating and motor speed controls. Standard phase control SCRs are triggered with few milliamperes of current at less than 1.5V potential.

Features & Benefits

- RoHS compliant
- Glass – passivated junctions
- Voltage capability up to 1000 V
- Surge capability up to 950 A

Applications

Typical applications are AC solid-state switches, industrial power tools, exercise equipment, white goods and commercial appliances.

Internally constructed isolated packages are offered for ease of heat sinking with highest isolation voltage.

Agency Approval

| Agency | Agency File Number |
|---|------------------------|
|  | J & K Packages: E71639 |

Main Features

| Symbol | Value | Unit |
|-------------------|-------------|------|
| $I_{T(RMS)}$ | 65 & 70 | A |
| V_{DRM}/V_{RRM} | 400 to 1000 | V |
| I_{GT} | 50 | mA |

Schematic Symbol

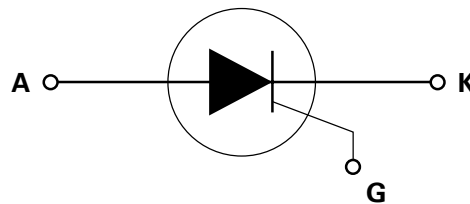

Absolute Maximum Ratings

| Symbol | Parameter | Test Conditions | | Value | Unit |
|--------------|---|--|--------------------------|------------|------------------------|
| | | Part | Temp | | |
| $I_{T(RMS)}$ | RMS on-state current | Sxx65J Sxx65K | $T_c = 75^\circ\text{C}$ | 65 | A |
| | | Sxx70W | $T_c = 80^\circ\text{C}$ | 70 | |
| $I_{T(AV)}$ | Average on-state current | Sxx65J Sxx65K | $T_c = 75^\circ\text{C}$ | 41.0 | A |
| | | Sxx70W | $T_c = 80^\circ\text{C}$ | 45.0 | A |
| I_{TSM} | Peak non-repetitive surge current | single half cycle; $f = 50\text{Hz}$; T_J (initial) = 25°C | | 800 | A |
| | | single half cycle; $f = 60\text{Hz}$; T_J (initial) = 25°C | | 950 | |
| I^2t | I^2t Value for fusing | $t_p = 8.3 \text{ ms}$ | | 3745 | A^2s |
| di/dt | Critical rate of rise of on-state current | $f = 60\text{Hz}$; $T_J = 125^\circ\text{C}$ | | 200 | $\text{A}/\mu\text{s}$ |
| I_{GM} | Peak gate current | $T_J = 125^\circ\text{C}$ $P_w = 15 \mu\text{S Max}$ | | 5.0 | A |
| $P_{G(AV)}$ | Average gate power dissipation | $T_J = 125^\circ\text{C}$ | | 1.0 | W |
| T_{stg} | Storage temperature range | | | -40 to 150 | $^\circ\text{C}$ |
| T_J | Operating junction temperature range | | | -40 to 125 | $^\circ\text{C}$ |

Electrical Characteristics (T_J = 25°C, unless otherwise specified)

| Symbol | Test Conditions | | Value | Unit | |
|-----------------|---|------|-------|------|------|
| I _{GT} | V _D = 12V; R _L = 30 Ω | | MAX. | 50 | mA |
| | | | MIN. | 5 | |
| V _{GT} | | | MAX. | 2.0 | V |
| dv/dt | V _D = V _{DRM} ; gate open; T _J = 100°C | 400V | MIN. | 650 | V/μs |
| | | 600V | | 600 | |
| | | 800V | | 500 | |
| | 1000V | 250 | | | |
| | V _D = V _{DRM} ; gate open; T _J = 125°C | 400V | | 550 | |
| | | 600V | | 500 | |
| 800V | | 475 | | | |
| V _{GD} | V _D = V _{DRM} ; R _L = 3.3 kΩ; T _J = 125°C | | MIN. | 0.2 | V |
| I _H | I _T = 400mA (initial) | | MAX. | 80 | mA |
| t _q | (1) | | MAX. | 35 | μs |
| t _{gt} | I _G = 2 × I _{GT} ; PW = 15μs; I _T = 140A | | TYP. | 2.5 | μs |

Note :

(1) I_T=2A; t_p=50μs; dv/dt=5V/μs; di/dt=30A/μs

Static Characteristics

| Symbol | Test Conditions | | Value | Unit | | |
|-------------------------------------|--|------------------------|-------------|------|------|----|
| V _{TM} | 65A Device I _T = 130A; t _p = 380μs | | MAX. | 1.8 | V | |
| | 70A Device I _T = 140A; t _p = 380μs | | | | | |
| I _{DRM} / I _{RRM} | V _{DRM} / V _{RRM} | T _J = 25°C | 400 – 800V | MAX. | 20 | μA |
| | | | 1000 V | | 30 | |
| | | T _J = 100°C | 400 – 600V | | 1500 | |
| | | | 800V | | 2000 | |
| | | | 1000V | | 5000 | |
| | | | 400V – 600V | | 3000 | |
| | | T _J = 125°C | 800V | | 5000 | |

Thermal Resistances

| Symbol | Parameter | Value | Unit | |
|---------------------|-----------------------|------------------|------|------|
| R _{θ(J-C)} | Junction to case (AC) | Sxx65J Sxx65K | 0.86 | °C/W |
| | | Sxx70W | 0.6 | |

Note: xx = voltage

Additional Information



Datasheet



Resources



Samples

Figure 1: Normalized DC Gate Trigger Current vs. Junction Temperature

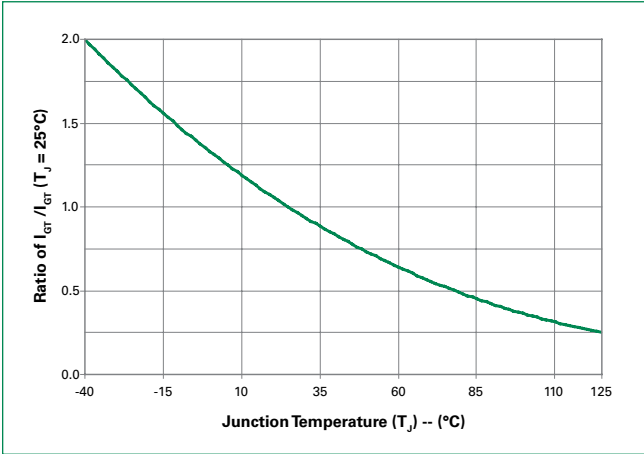

Figure 2: Normalized DC Gate Trigger Voltage vs. Junction Temperature

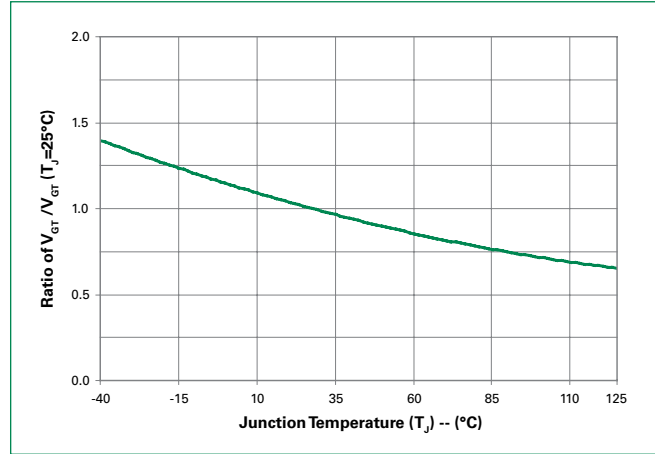

Figure 3: Normalized DC Holding Current vs. Junction Temperature

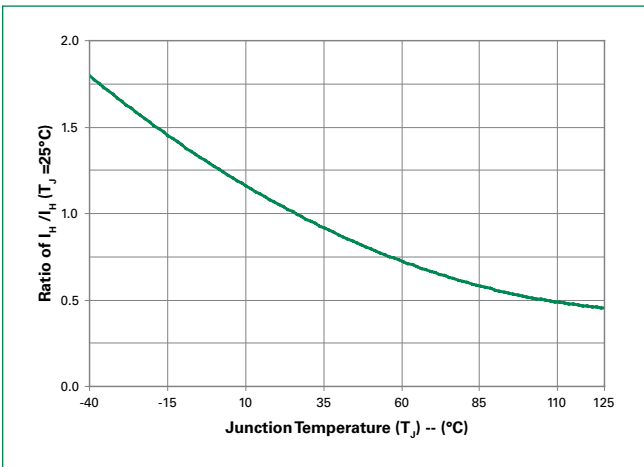

Figure 4: On-State Current vs. On-State Voltage (Typical)

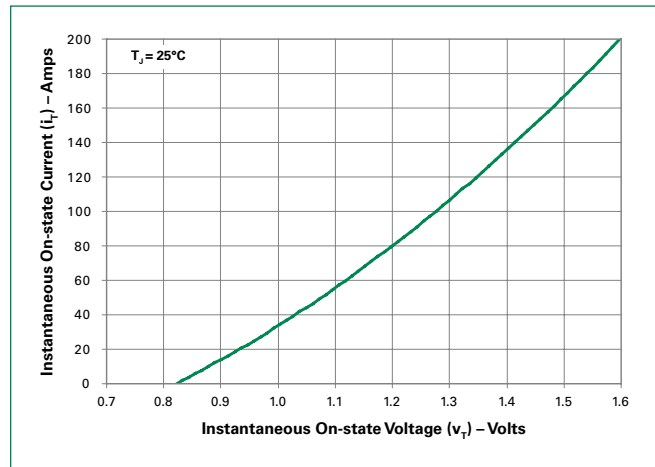

Figure 5: Power Dissipation (Typical) vs. RMS On-State Current

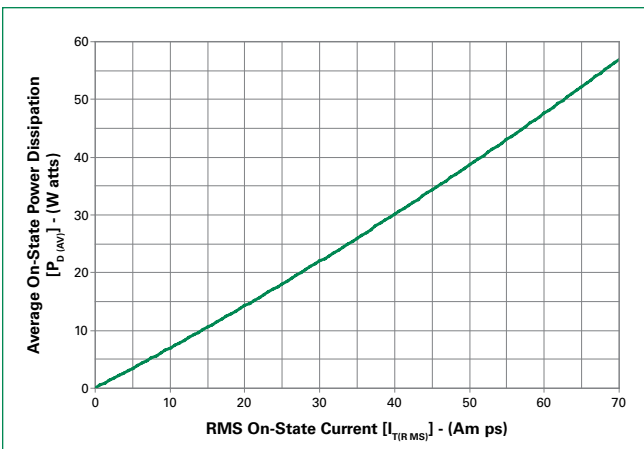
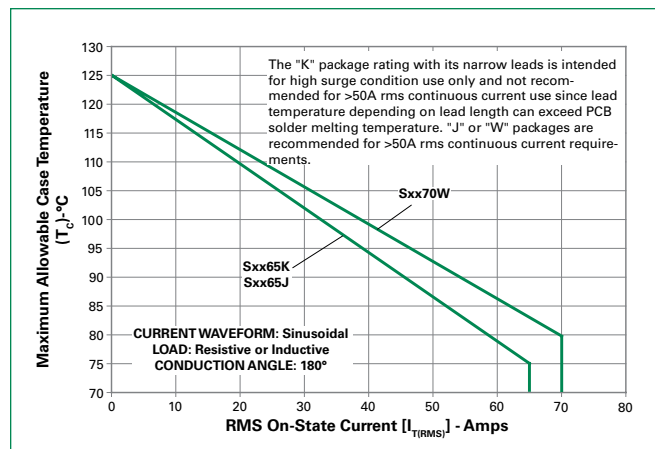

Figure 6: Maximum Allowable Case Temperature vs. RMS On-State Current



Note: xx = voltage

Figure 7: Maximum Allowable Case Temperature vs. Average On-State Current

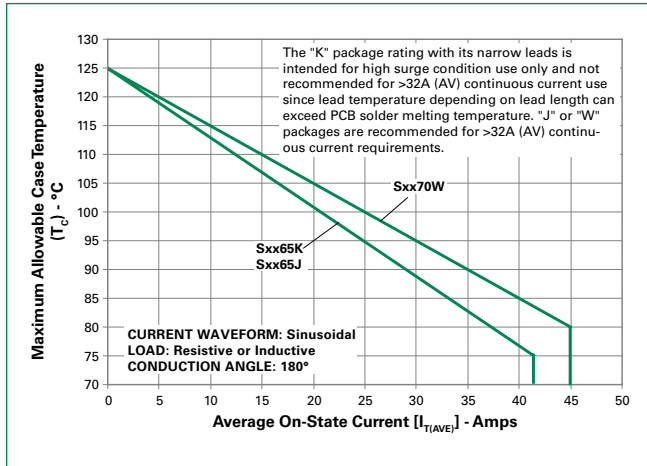

Figure 8: Peak Capacitor Discharge Current

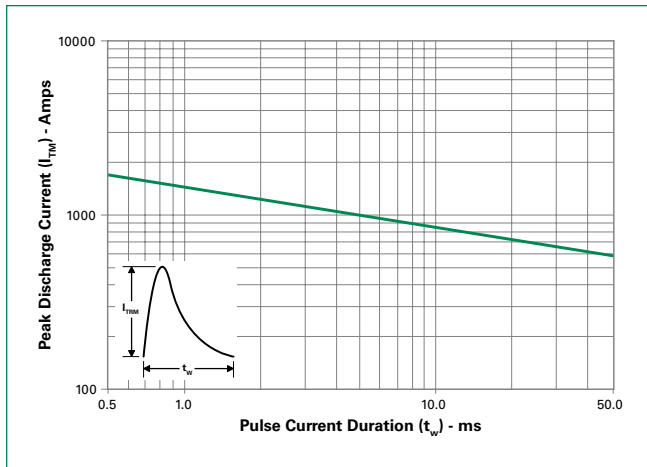

Figure 9: Peak Capacitor Discharge Current Derating

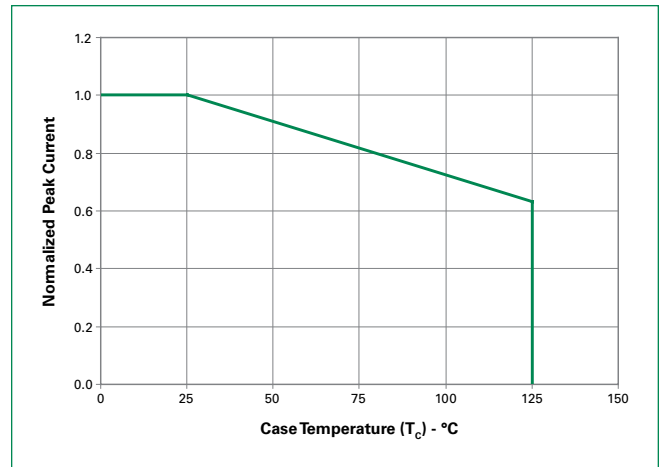
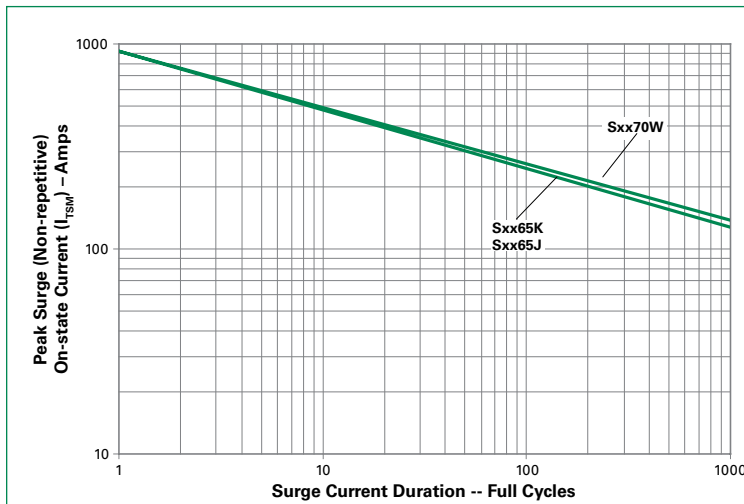

Figure 10: Surge Peak On-State Current vs. Number of Cycles



SUPPLY FREQUENCY: 60 Hz Sinusoidal
LOAD: Resistive
RMS On-State Current: $I_{T(RMS)}$: Maximum Rated Value at Specified Case Temperature

Notes:

1. Gate control may be lost during and immediately following surge current interval.
2. Overload may not be repeated until junction temperature has returned to steady-state rated value.

Note: xx = Voltage

Soldering Parameters

| | | |
|--|------------------------------------|-------------------------|
| Reflow Condition | | Pb – Free assembly |
| Pre Heat | - Temperature Min ($T_{s(min)}$) | 150°C |
| | - Temperature Max ($T_{s(max)}$) | 200°C |
| | - Time (min to max) (t_s) | 60 – 180 secs |
| Average ramp up rate (Liquidus Temp) (T_L) to peak | | 5°C/second max |
| $T_{s(max)}$ to T_L - Ramp-up Rate | | 5°C/second max |
| Reflow | - Temperature (T_L) (Liquidus) | 217°C |
| | - Temperature (t_l) | 60 – 150 seconds |
| Peak Temperature (T_p) | | 260 ^{+0/-5} °C |
| Time within 5°C of actual peak Temperature (t_p) | | 20 – 40 seconds |
| Ramp-down Rate | | 5°C/second max |
| Time 25°C to peak Temperature (T_p) | | 8 minutes Max. |
| Do not exceed | | 280°C |

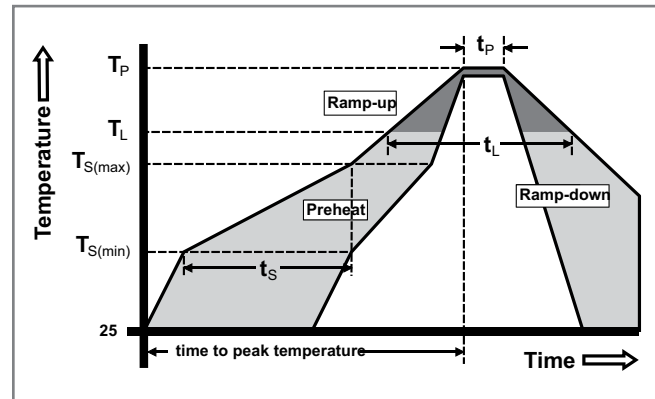

Physical Specifications

| | |
|------------------------|---|
| Terminal Finish | 100% Matte Tin-plated |
| Body | UL recognized epoxy meeting flammability classification 94V-0 |
| Lead Material | Copper Alloy |

Design Considerations

Careful selection of the correct device for the application's operating parameters and environment will go a long way toward extending the operating life of the Thyristor. Good design practice should limit the maximum continuous current through the main terminals to 75% of the device rating. Other ways to ensure long life for a power discrete semiconductor are proper heat sinking and selection of voltage ratings for worst case conditions. Overheating, overvoltage (including dv/dt), and surge currents are the main killers of semiconductors. Correct mounting, soldering, and forming of the leads also help protect against component damage.

Environmental Specifications

| Test | Specifications and Conditions |
|----------------------------------|--|
| AC Blocking | MIL-STD-750, M-1040, Cond A Applied Peak AC voltage @ 125°C for 1008 hours |
| Temperature Cycling | MIL-STD-750, M-1051, 100 cycles; -40°C to +150°C; 15-min dwell-time |
| Temperature/Humidity | EIA / JEDEC, JESD22-A101 1008 hours; 320V - DC; 85°C; 85% rel humidity |
| High Temp Storage | MIL-STD-750, M-1031, 1008 hours; 150°C |
| Low-Temp Storage | 1008 hours; -40°C |
| Resistance to Solder Heat | MIL-STD-750 Method 2031 |
| Solderability | ANSI/J-STD-002, category 3, Test A |
| Lead Bend | MIL-STD-750, M-2036 Cond E |

Dimensions – TO-218X (W Package) – Non-Isolated Mounting Tab common with Center Lead

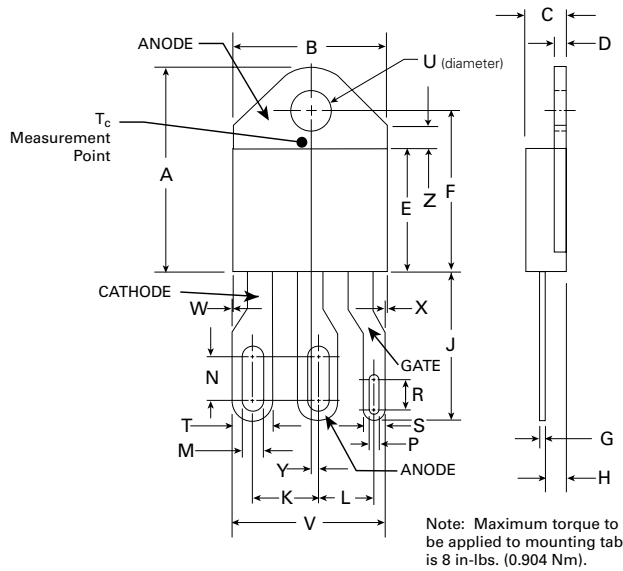

| Dimension | Inches | | Millimeters | |
|-----------|--------|-------|-------------|-------|
| | Min | Max | Min | Max |
| A | 0.810 | 0.835 | 20.57 | 21.21 |
| B | 0.610 | 0.630 | 15.49 | 16.00 |
| C | 0.178 | 0.188 | 4.52 | 4.78 |
| D | 0.055 | 0.070 | 1.40 | 1.78 |
| E | 0.487 | 0.497 | 12.37 | 12.62 |
| F | 0.635 | 0.655 | 16.13 | 16.64 |
| G | 0.022 | 0.029 | 0.56 | 0.74 |
| H | 0.075 | 0.095 | 1.91 | 2.41 |
| J | 0.575 | 0.625 | 14.61 | 15.88 |
| K | 0.256 | 0.264 | 6.50 | 6.71 |
| L | 0.220 | 0.228 | 5.58 | 5.79 |
| M | 0.080 | 0.088 | 2.03 | 2.24 |
| N | 0.169 | 0.177 | 4.29 | 4.49 |
| P | 0.034 | 0.042 | 0.86 | 1.07 |
| R | 0.113 | 0.121 | 2.87 | 3.07 |
| S | 0.086 | 0.096 | 2.18 | 2.44 |
| T | 0.156 | 0.166 | 3.96 | 4.22 |
| U | 0.164 | 0.165 | 4.10 | 4.20 |
| V | 0.603 | 0.618 | 15.31 | 15.70 |
| W | 0.000 | 0.005 | 0.00 | 0.13 |
| X | 0.003 | 0.012 | 0.07 | 0.30 |
| Y | 0.028 | 0.032 | 0.71 | 0.81 |
| Z | 0.085 | 0.095 | 2.17 | 2.42 |

Dimensions – TO-218AC (K Package) – Isolated Mounting Tab

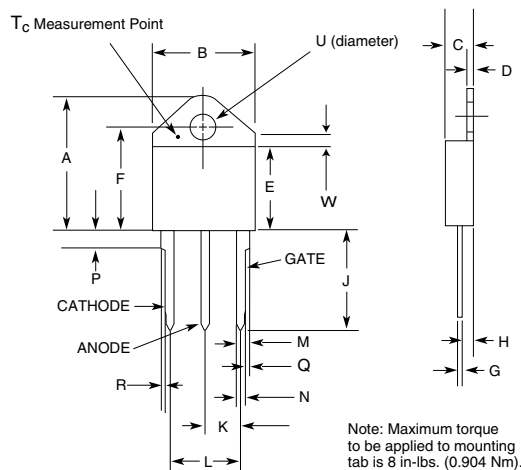

| Dimension | Inches | | Millimeters | |
|-----------|--------|-------|-------------|-------|
| | Min | Max | Min | Max |
| A | 0.810 | 0.835 | 20.57 | 21.21 |
| B | 0.610 | 0.630 | 15.49 | 16.00 |
| C | 0.178 | 0.188 | 4.52 | 4.78 |
| D | 0.055 | 0.070 | 1.40 | 1.78 |
| E | 0.487 | 0.497 | 12.37 | 12.62 |
| F | 0.635 | 0.655 | 16.13 | 16.64 |
| G | 0.022 | 0.029 | 0.56 | 0.74 |
| H | 0.075 | 0.095 | 1.91 | 2.41 |
| J | 0.575 | 0.625 | 14.61 | 15.88 |
| K | 0.211 | 0.219 | 5.36 | 5.56 |
| L | 0.422 | 0.437 | 10.72 | 11.10 |
| M | 0.058 | 0.068 | 1.47 | 1.73 |
| N | 0.045 | 0.055 | 1.14 | 1.40 |
| P | 0.095 | 0.115 | 2.41 | 2.92 |
| Q | 0.008 | 0.016 | 0.20 | 0.41 |
| R | 0.008 | 0.016 | 0.20 | 0.41 |
| U | 0.164 | 0.165 | 4.10 | 4.20 |
| W | 0.085 | 0.095 | 2.17 | 2.42 |

Dimensions – TO-218X (J Package) – Isolated Mounting Tab

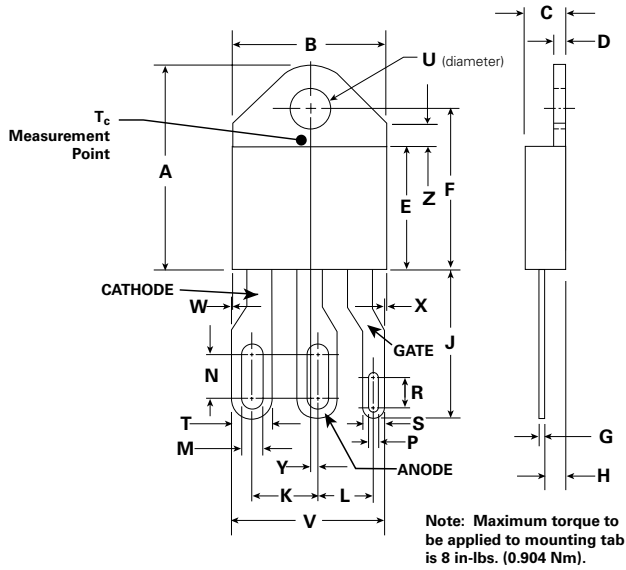

| Dimension | Inches | | Millimeters | |
|-----------|--------|-------|-------------|-------|
| | Min | Max | Min | Max |
| A | 0.810 | 0.835 | 20.57 | 21.21 |
| B | 0.610 | 0.630 | 15.49 | 16.00 |
| C | 0.178 | 0.188 | 4.52 | 4.78 |
| D | 0.055 | 0.070 | 1.40 | 1.78 |
| E | 0.487 | 0.497 | 12.37 | 12.62 |
| F | 0.635 | 0.655 | 16.13 | 16.64 |
| G | 0.022 | 0.029 | 0.56 | 0.74 |
| H | 0.075 | 0.095 | 1.91 | 2.41 |
| J | 0.575 | 0.625 | 14.61 | 15.88 |
| K | 0.256 | 0.264 | 6.50 | 6.71 |
| L | 0.220 | 0.228 | 5.58 | 5.79 |
| M | 0.080 | 0.088 | 2.03 | 2.24 |
| N | 0.169 | 0.177 | 4.29 | 4.49 |
| P | 0.034 | 0.042 | 0.86 | 1.07 |
| R | 0.113 | 0.121 | 2.87 | 3.07 |
| S | 0.086 | 0.096 | 2.18 | 2.44 |
| T | 0.156 | 0.166 | 3.96 | 4.22 |
| U | 0.164 | 0.165 | 4.10 | 4.20 |
| V | 0.603 | 0.618 | 15.31 | 15.70 |
| W | 0.000 | 0.005 | 0.00 | 0.13 |
| X | 0.003 | 0.012 | 0.07 | 0.30 |
| Y | 0.028 | 0.032 | 0.71 | 0.81 |
| Z | 0.085 | 0.095 | 2.17 | 2.42 |

Product Selector

| Part Number | Voltage | | | | Gate Sensitivity | Type | Package |
|-------------|---------|------|------|-------|------------------|--------------|----------|
| | 400V | 600V | 800V | 1000V | | | |
| Sxx65K | X | X | X | X | 50mA | Standard SCR | TO-218AC |
| Sxx65J | X | X | X | | 50mA | Standard SCR | TO-218X |
| Sxx70W | X | X | X | | 50mA | Standard SCR | TO-218X |

Note: xx = Voltage

Packing Options

| Part Number | Marking | Weight | Packing Mode | Base Quantity |
|-------------|---------|--------|--------------|-------------------|
| Sxx65KTP | Sxx65K | 4.40g | Tube | 250 (25 per tube) |
| Sxx65JTP | Sxx65J | 5.23g | Tube | 250 (25 per tube) |
| Sxx70WTP | Sxx70W | 5.23g | Tube | 250 (25 per tube) |

Note: xx = Voltage

Part Numbering System

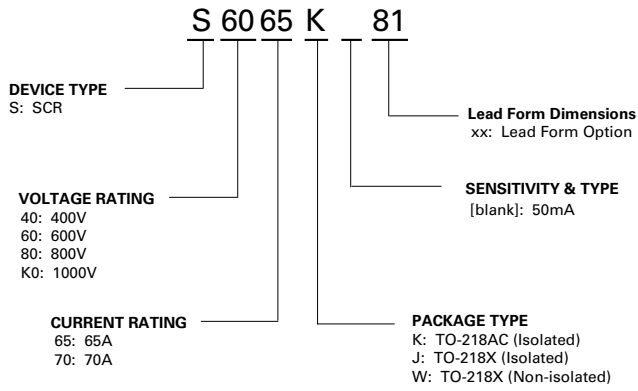

Part Marking System

- TO-218AC - (K Package)
- TO-218X - (J Package)
- TO-218X - (W Package)

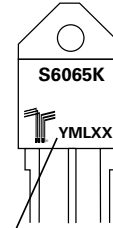

Date Code Marking
Y: Year Code
M: Month Code
L: Location Code
XX: Lot Serial Code

X-ON Electronics

Largest Supplier of Electrical and Electronic Components

Click to view similar products for [SCRs category](#):

Click to view products by [Littelfuse manufacturer](#):

Other Similar products are found below :

[NTE5428](#) [T1500N16TOF VT](#) [TT162N16KOF-A](#) [TT162N16KOF-K](#) [TT330N16AOF](#) [VS-22RIA20](#) [VS-2N685](#) [057219R](#) [T1190N16TOF VT](#)
[T1220N22TOF VT](#) [T201N70TOH](#) [T700N22TOF](#) [T830N18TOF](#) [TT250N12KOF-K](#) [VS-16RIA120](#) [VS-110RKI40](#) [NTE5427](#) [NTE5442](#)
[TT251N16KOF-K](#) [VS-22RIA100](#) [VS-16RIA40](#) [TD250N16KOF-A](#) [VS-ST110S16P0](#) [T930N36TOF VT](#) [T2160N24TOF VT](#) [T1190N18TOF](#)
[VT](#) [T1590N28TOF VT](#) [2N1776A](#) [T590N14TOF](#) [NTE5375](#) [NTE5460](#) [NTE5481](#) [NTE5512](#) [NTE5514](#) [NTE5518](#) [NTE5519](#) [NTE5529](#)
[NTE5553](#) [NTE5555](#) [NTE5557](#) [NTE5567](#) [NTE5570](#) [NTE5572](#) [NTE5574](#) [NTE5576](#) [NTE5578](#) [NTE5579](#) [NTE5589](#) [NTE5592](#) [NTE5598](#)