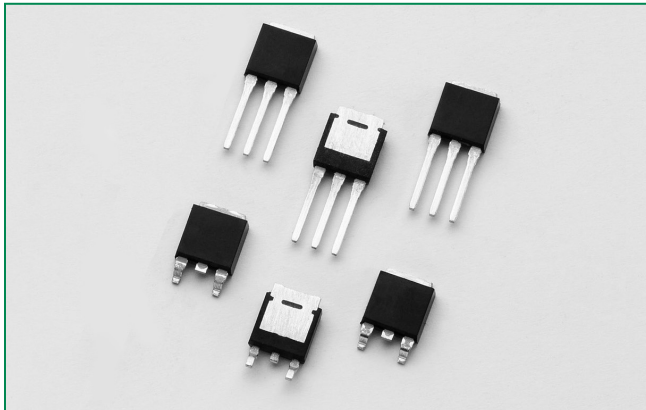


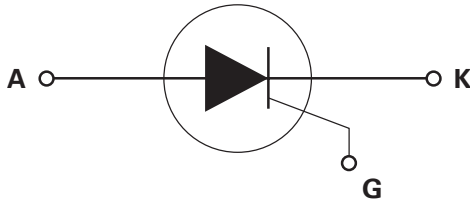
**SJxx08xSx & SJxx08xx Series**



**Main Features**

Symbol	Value	Unit
$I_{T(RMS)}$	8	A
$V_{DRM}/V_{RRM}$	400 or 600	V
$I_{GT}$	0.2 to 15	mA

**Schematic Symbol**



**Description**

This SJxx080xx high temperature SCR series is ideal for uni-directional switch applications such as phase control in heating, motor speed controls, converters/rectifiers and capacitive discharge ignitions.

These SCRs have a low gate current trigger level of 6mA or 15mA maximum at approximately 1.5V, with a sensitive version of this series having a gate trigger current less than 200µA. The sensitive gate SCR version is easily triggered by sense coils, proximity switches, and microprocessors.

**Features & Benefits**

- Voltage capability up to 600 V
- Surge capability up to 100 A at 60 Hz half cycle
- 150°C maximum junction temperature
- Halogen free and RoHS compliant

**Applications**

Typical applications includes capacitive discharge system for motorcycle engine CDI, portable generator engine ignition, strobe lights and nailers, as well as generic rectifiers, battery voltage regulators and converters. Also controls for power tools, home/brown goods and white goods appliances.

**Absolute Maximum Ratings – Sensitive SCRs**

Symbol	Parameter	Test Conditions	Value	Unit
$I_{T(RMS)}$	RMS on-state current	$T_c = 120^\circ\text{C}$	8	A
$I_{T(AV)}$	Average on-state current	$T_c = 120^\circ\text{C}$	5.1	A
$I_{TSM}$	Peak non-repetitive surge current	single half cycle; $f = 50\text{ Hz}$ ; $T_j(\text{initial}) = 25^\circ\text{C}$	83	A
		single half cycle; $f = 60\text{ Hz}$ ; $T_j(\text{initial}) = 25^\circ\text{C}$	100	
$I^2t$	$I^2t$ Value for fusing	$t_p = 8.3\text{ ms}$	41	$\text{A}^2\text{s}$
$di/dt$	Critical rate of rise of on-state current	$f = 60\text{ Hz}$ , $T_j = 150^\circ\text{C}$	70	$\text{A}/\mu\text{s}$
$I_{GM}$	Peak gate current	$Pw=20\ \mu\text{s}$ , $T_j = 150^\circ\text{C}$	0.5	A
$P_{G(AV)}$	Average gate power dissipation	$T_j = 150^\circ\text{C}$	0.1	W
$T_{stg}$	Storage temperature range		-40 to 150	$^\circ\text{C}$
$T_j$	Operating junction temperature range		-40 to 150	$^\circ\text{C}$
$V_{DSM}/V_{RSM}$	Peak non-repetitive blocking voltage	$Pw=100\ \mu\text{s}$	$V_{DRM}/V_{RRM}+100$	V

### Absolute Maximum Ratings – Standard SCRs

Symbol	Parameter	Test Conditions	Value	Unit
$I_{T(RMS)}$	RMS on-state current	$T_C = 125^\circ\text{C}$	8	A
$I_{T(AV)}$	Average on-state current	$T_C = 125^\circ\text{C}$	5.1	A
$I_{TSM}$	Peak non-repetitive surge current	single half cycle; $f = 50\text{ Hz}$ ; $T_J(\text{initial}) = 25^\circ\text{C}$	83	A
		single half cycle; $f = 60\text{ Hz}$ ; $T_J(\text{initial}) = 25^\circ\text{C}$	100	
$I^2t$	$I^2t$ Value for fusing	$t_p = 8.3\text{ ms}$	41	$\text{A}^2\text{s}$
$di/dt$	Critical rate-of-rise of on-state current	$f = 60\text{ Hz}$ , $T_J = 150^\circ\text{C}$	100	$\text{A}/\mu\text{s}$
$I_{GM}$	Peak gate current	$Pw=20\ \mu\text{s}$ , $T_J = 150^\circ\text{C}$	0.5	A
$P_{G(AV)}$	Average gate power dissipation	$T_J = 150^\circ\text{C}$	0.1	W
$T_{stg}$	Storage temperature range		-40 to 150	$^\circ\text{C}$
$T_J$	Operating junction temperature range		-40 to 150	$^\circ\text{C}$
$V_{DSM}/V_{RSM}$	Peak non-repetitive blocking voltage	$Pw=100\ \mu\text{s}$	$V_{DRM}/V_{RRM}+100$	V

### Electrical Characteristics ( $T_J = 25^\circ\text{C}$ , unless otherwise specified) – Sensitive SCRs

Symbol	Test Conditions		Value	Unit
			SJxx08xS2	
$I_{GT}$	$V_D = 6\text{ V}$ , $R_L = 100\ \Omega$	MIN.	20	$\mu\text{A}$
		MAX.	200	$\mu\text{A}$
$V_{GT}$		MAX.	0.8	V
$dv/dt$	$V_D = V_{DRM}$ ; $R_{GK} = 220\ \Omega$ ; $T_J = 125^\circ\text{C}$	MIN.	15	$\text{V}/\mu\text{s}$
$V_{GD}$	$V_D = V_{DRM}$ ; $R_L = 3.3\ \text{k}\Omega$ ; $T_J = 125^\circ\text{C}$	MIN.	0.2	V
	$V_D = V_{DRM}$ ; $R_L = 3.3\ \text{k}\Omega$ ; $T_J = 150^\circ\text{C}$	MIN.	0.1	V
$V_{GRM}$	$I_{GR} = 10\ \mu\text{A}$	MIN.	6	V
$I_H$	$I_T = 20\text{ mA}$ (initial)	MAX.	6	mA
$t_q$	$t_p=50\ \mu\text{s}$ ; $dv/dt=5\text{ V}/\mu\text{s}$ ; $di/dt=-30\text{ A}/\mu\text{s}$	MAX.	130	$\mu\text{s}$
$t_{gt}$	$I_G = 2 \times I_{GT}$ ; $PW = 15\ \mu\text{s}$ ; $I_T = 8\text{ A}$	TYP.	6	$\mu\text{s}$

NOTE: xx = voltage

### Electrical Characteristics ( $T_J = 25^\circ\text{C}$ , unless otherwise specified) – Standard SCRs

Symbol	Test Conditions		Value		Unit
			SJxx08x1	SJxx08x	
$I_{GT}$	$V_D = 12\text{ V}$ , $R_L = 60\ \Omega$	MAX.	6	15	mA
		MAX.	1.5	1.5	V
$dv/dt$	$V_D = V_{DRM}$ ; gate open; $T_J = 125^\circ\text{C}$	MIN.	100	200	$\text{V}/\mu\text{s}$
	$V_D = V_{DRM}$ ; gate open; $T_J = 150^\circ\text{C}$		50	120	
$V_{GD}$	$V_D = V_{DRM}$ ; $R_L = 3.3\ \text{k}\Omega$ ; $T_J = 125^\circ\text{C}$	MIN.	0.2	0.2	V
	$V_D = V_{DRM}$ ; $R_L = 3.3\ \text{k}\Omega$ ; $T_J = 150^\circ\text{C}$	MIN.	0.1	0.1	
$I_H$	$I_T = 200\text{ mA}$ (initial)	MAX.	20	30	mA
$t_q$	$I_T=0.5\text{ A}$ ; $t_p=50\ \mu\text{s}$ ; $dv/dt=5\text{ V}/\mu\text{s}$ ; $di/dt=-30\text{ A}/\mu\text{s}$	MAX.	30	35	$\mu\text{s}$
$t_{gt}$	$I_G = 2 \times I_{GT}$ ; $PW = 15\ \mu\text{s}$ ; $I_T = 8\text{ A}$	TYP.	0.5	2	$\mu\text{s}$

NOTE: xx = voltage

### Static Characteristics

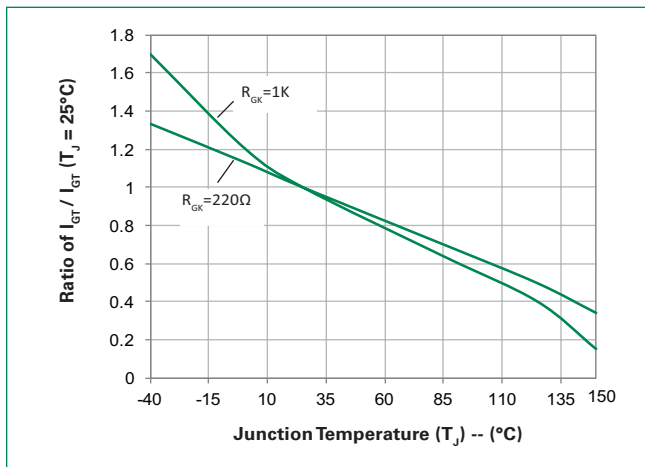
Symbol	Test Conditions		Value	Unit			
$V_{TM}$	$I_T = 16A; t_p = 380 \mu s$		MAX.	1.6	V		
$I_{DRM} / I_{RRM}$	@ $V_{DRM} / V_{RRM}$	SJxx08xS2	$T_J = 25^\circ C$	400 - 600V	MAX.	5	$\mu A$
			$T_J = 125^\circ C, R_{GK} = 220\Omega$	400 - 600V		1000	
			$T_J = 150^\circ C, R_{GK} = 220\Omega$	400 - 600V		3000	
	SJxx08xx	$T_J = 25^\circ C$	400 - 600V	10			
		$T_J = 125^\circ C$	400 - 600V	1000			
		$T_J = 150^\circ C$	400 - 600V	3000			

### Thermal Resistances

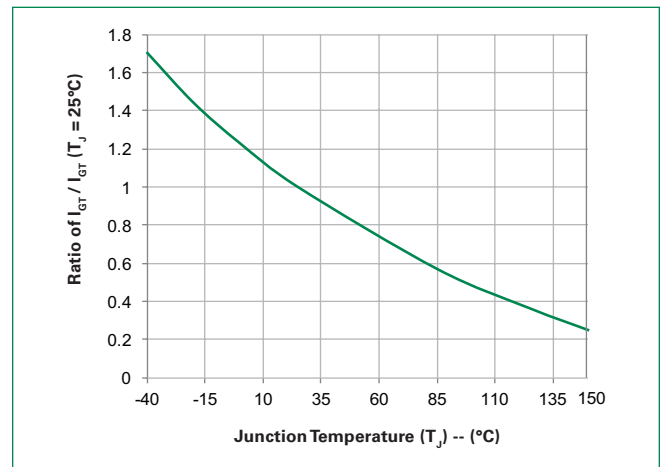
Symbol	Parameter	Value	Unit
$R_{\theta(J-C)}$	Junction to case (AC)	SJxx08xS2	1.2
		SJxx08xx	1.2

Note: xx = voltage

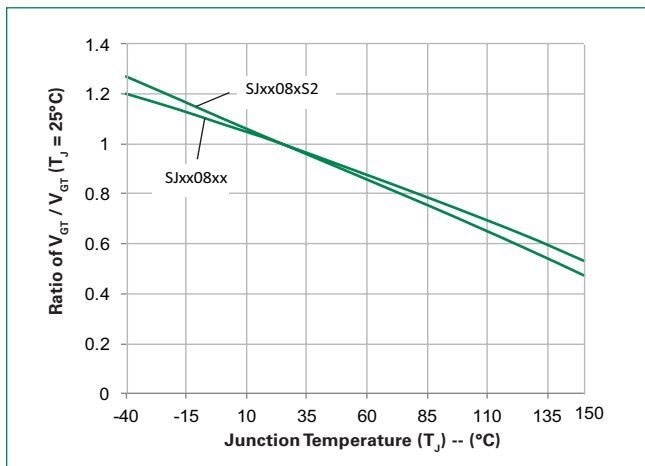
**Figure 1: Normalized DC Gate Trigger Current vs. Junction Temperature (Sensitive SCR)**



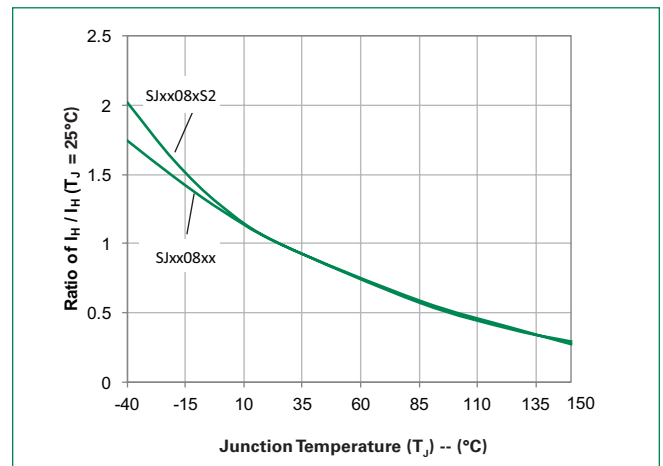
**Figure 2: Normalized DC Gate Trigger Current vs. Junction Temperature (Standard SCR)**



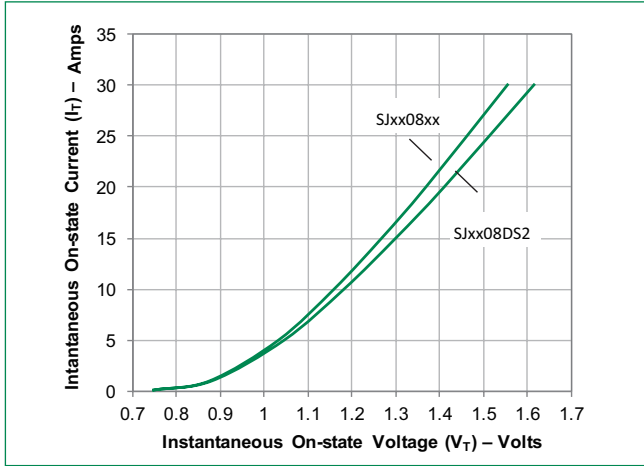
**Figure 3: Normalized DC Gate Trigger Voltage vs. Junction Temperature**



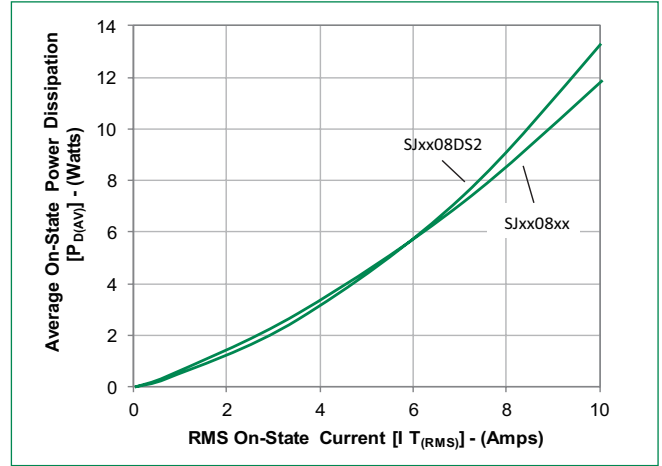
**Figure 4: Normalized DC Holding Current vs. Junction Temperature**



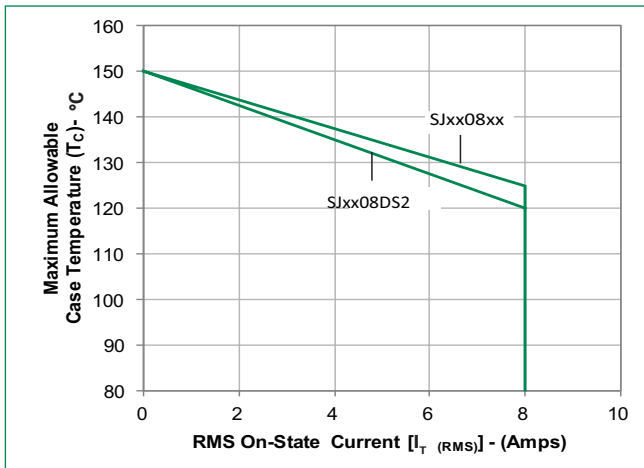
**Figure 5: On-State Current vs. On-State Voltage (Typical)**



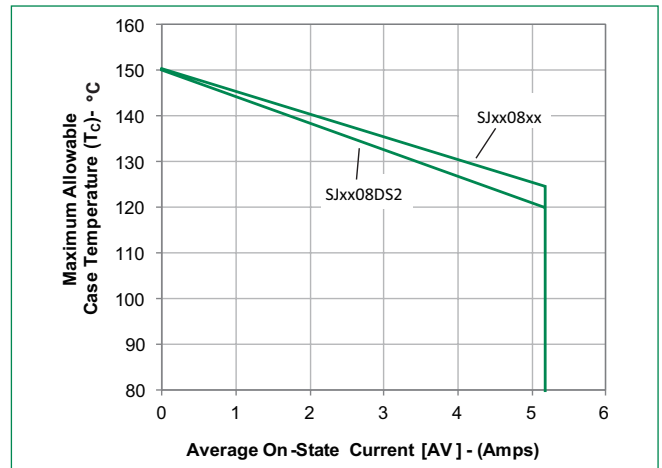
**Figure 6: Power Dissipation (Typical) vs. RMS On-State Current**



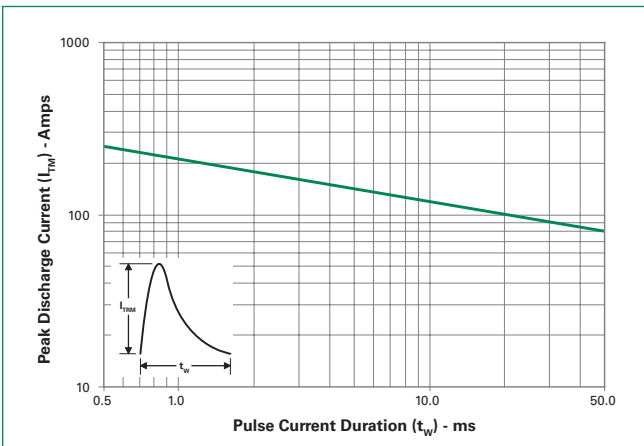
**Figure 7: Maximum Allowable Case Temperature vs. RMS On-State Current**



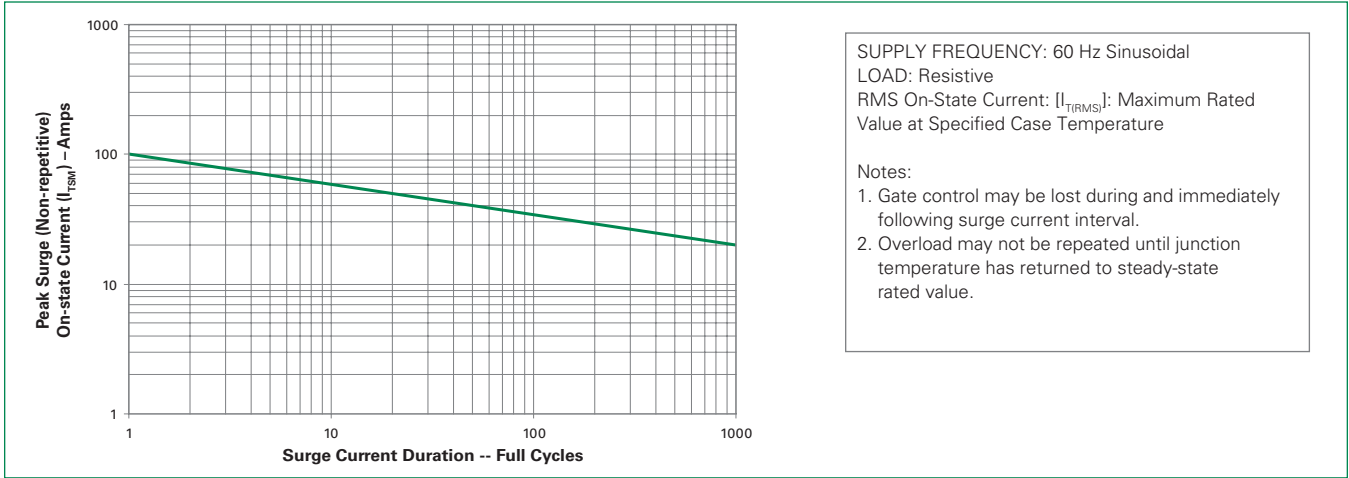
**Figure 8: Maximum Allowable Case Temperature vs. Average On-State Current**



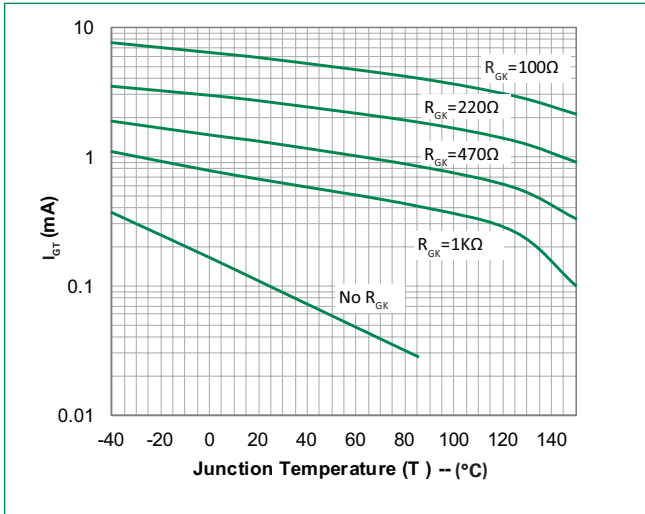
**Figure 9: Peak Capacitor Discharge Current**



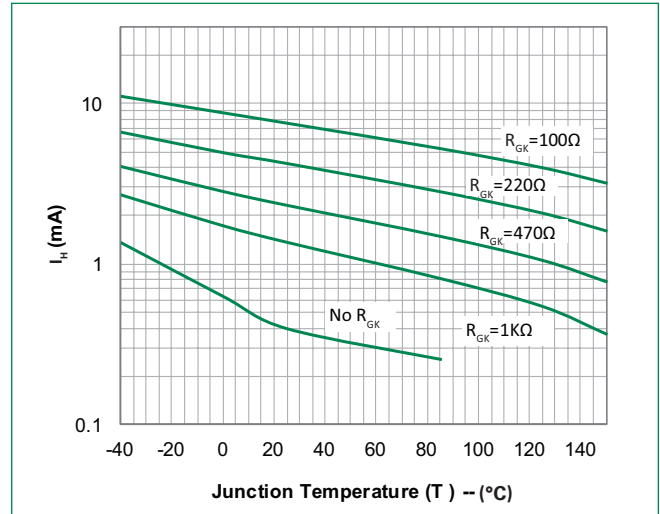
**Figure 10: Surge Peak On-State Current vs. Number of Cycles**



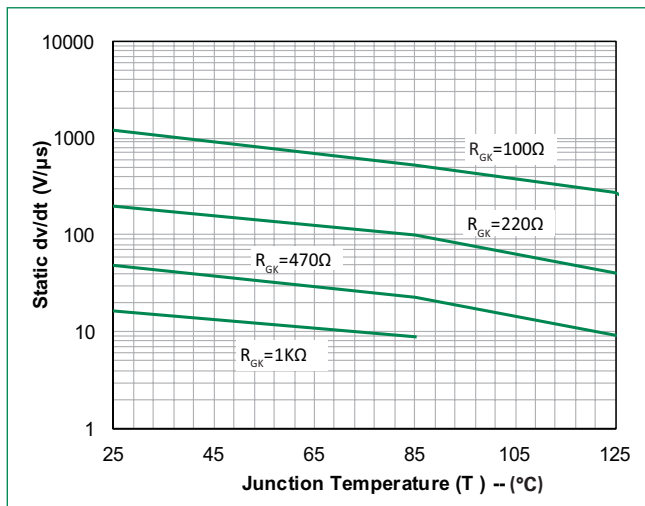
**Figure 11: Typical DC Gate Trigger Current with  $R_{GK}$  vs. Junction Temperature (Sensitive SCR)**



**Figure 12: Typical DC Holding Current with  $R_{GK}$  vs. Junction Temperature (Sensitive SCR)**

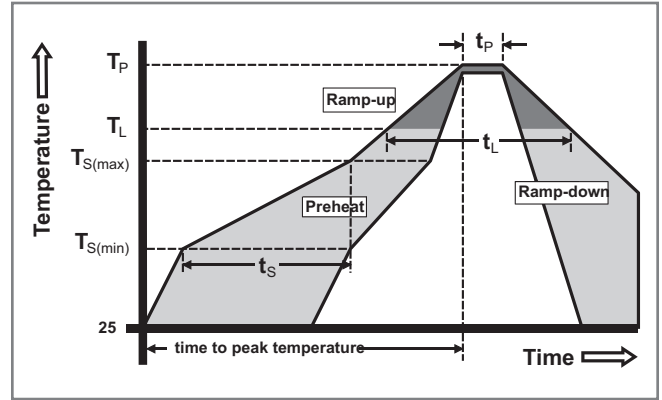


**Figure 13: Typical Static dv/dt with  $R_{GK}$  vs. Junction Temperature (Sensitive SCR)**



**Soldering Parameters**

Reflow Condition		Pb – Free assembly
Pre Heat	- Temperature Min ( $T_{s(min)}$ )	150°C
	- Temperature Max ( $T_{s(max)}$ )	200°C
	- Time (min to max) ( $t_s$ )	60 – 180 secs
Average ramp up rate (Liquidus Temp ( $T_L$ ) to peak)		5°C/second max
$T_{s(max)}$ to $T_L$ - Ramp-up Rate		5°C/second max
Reflow	- Temperature ( $T_L$ ) (Liquidus)	217°C
	- Time ( $t_L$ )	60 – 150 seconds
Peak Temperature ( $T_p$ )		260 <sup>+0/-5</sup> °C
Time within 5°C of actual peak Temperature ( $t_p$ )		20 – 40 seconds
Ramp-down Rate		5°C/second max
Time 25°C to peak Temperature ( $T_p$ )		8 minutes Max.
Do not exceed		280°C



**Physical Specifications**

<b>Terminal Finish</b>	100% Matte Tin-plated
<b>Body Material</b>	UL Recognized epoxy meeting flammability rating V-0
<b>Lead Material</b>	Copper Alloy

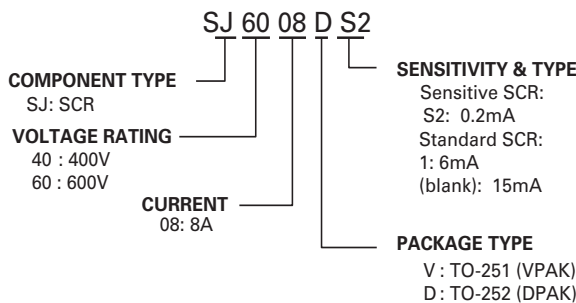
**Design Considerations**

Careful selection of the correct component for the application's operating parameters and environment will go a long way toward extending the operating life of the Thyristor. Good design practice should limit the maximum continuous current through the main terminals to 75% of the component rating. Other ways to ensure long life for a power discrete semiconductor are proper heat sinking and selection of voltage ratings for worst case conditions. Overheating, overvoltage (including dv/dt), and surge currents are the main killers of semiconductors. Correct mounting, soldering, and forming of the leads also help protect against component damage.

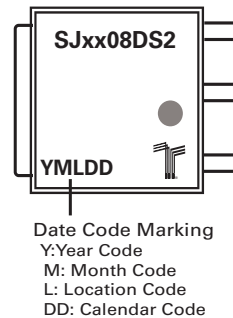
**Environmental Specifications**

Test	Specifications and Conditions
<b>AC Blocking</b>	MIL-STD-750, M-1040, Cond A Applied Peak AC voltage for 1008 hours
<b>Temperature Cycling</b>	MIL-STD-750, M-1051, 100 cycles; -40°C to +150°C; 15-min dwell-time
<b>Temperature/Humidity</b>	EIA / JEDEC, JESD22-A101 1008 hours; 160V - DC: 85°C; 85% rel humidity
<b>High Temp Storage</b>	MIL-STD-750, M-1031, 1008 hours; 150°C
<b>Low-Temp Storage</b>	1008 hours; -40°C
<b>Resistance to Solder Heat</b>	MIL-STD-750 Method 2031
<b>Solderability</b>	ANSI/J-STD-002, category 3, Test A
<b>Lead Bend</b>	MIL-STD-750, M-2036 Cond E
<b>Moisture Sensitivity Level</b>	Level 1, JEDEC-J-STD-020

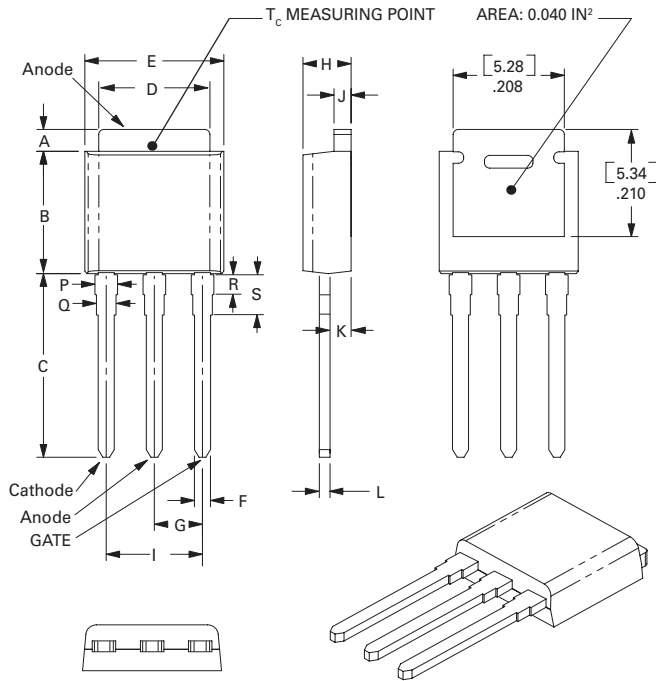
**Part Numbering System**



**Part Marking System**

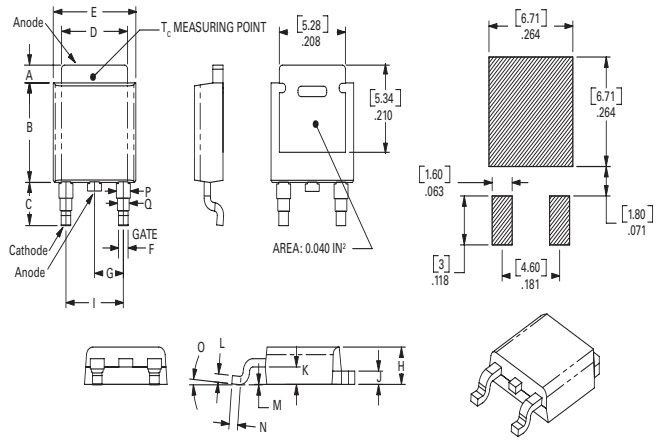


### Dimensions — TO-251AA (V/I-Package) — V/I-PAK Through Hole



Dimension	Inches			Millimeters		
	Min	Typ	Max	Min	Typ	Max
A	0.037	0.040	0.043	0.94	1.01	1.09
B	0.235	0.242	0.245	5.97	6.15	6.22
C	0.350	0.361	0.375	8.89	9.18	9.53
D	0.205	0.208	0.213	5.21	5.29	5.41
E	0.255	0.262	0.265	6.48	6.66	6.73
F	0.027	0.031	0.033	0.69	0.80	0.84
G	0.087	0.090	0.093	2.21	2.28	2.36
H	0.085	0.092	0.095	2.16	2.34	2.41
I	0.176	0.180	0.184	4.47	4.57	4.67
J	0.018	0.020	0.023	0.46	0.51	0.58
K	0.035	0.037	0.039	0.90	0.95	1.00
L	0.018	0.020	0.023	0.46	0.52	0.58
P	0.042	0.047	0.052	1.06	1.20	1.32
Q	0.034	0.039	0.044	0.86	1.00	1.11
R	0.034	0.039	0.044	0.86	1.00	1.11
S	0.074	0.079	0.084	1.86	2.00	2.11

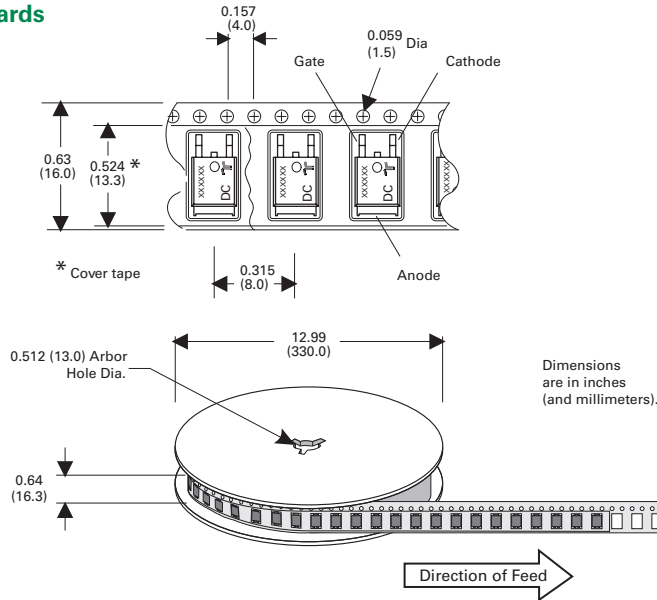
### Dimensions — TO-252AA (D-Package) — D-PAK Surface Mount



Dimension	Inches			Millimeters		
	Min	Typ	Max	Min	Typ	Max
A	0.037	0.040	0.043	0.94	1.01	1.09
B	0.235	0.243	0.245	5.97	6.16	6.22
C	0.106	0.108	0.113	2.69	2.74	2.87
D	0.205	0.208	0.213	5.21	5.29	5.41
E	0.255	0.262	0.265	6.48	6.65	6.73
F	0.027	0.031	0.033	0.69	0.80	0.84
G	0.087	0.090	0.093	2.21	2.28	2.36
H	0.085	0.092	0.095	2.16	2.33	2.41
I	0.176	0.179	0.184	4.47	4.55	4.67
J	0.018	0.020	0.023	0.46	0.51	0.58
K	0.035	0.037	0.039	0.90	0.95	1.00
L	0.018	0.020	0.023	0.46	0.51	0.58
M	0.000	0.000	0.004	0.00	0.00	0.10
N	0.021	0.026	0.027	0.53	0.67	0.69
O	0°	0°	5°	0°	0°	5°
P	0.042	0.047	0.052	1.06	1.20	1.32
Q	0.034	0.039	0.044	0.86	1.00	1.11

### TO-252 Embossed Carrier Reel Pack (RP) Specifications

#### Meets all EIA-481-2 Standards



### Product Selector

Part Number	Voltage		Gate Sensitivity	Type	Package
	400V	600V			
SJxx08VS2	X	X	0.2mA	Sensitive SCR	TO-251
SJxx08DS2	X	X	0.2mA	Sensitive SCR	TO-252
SJxx08V	X	X	15mA	Standard SCR	TO-251
SJxx08D	X	X	15mA	Standard SCR	TO-252
SJxx08V1	X	X	6mA	Standard SCR	TO-251
SJxx08D1	X	X	6mA	Standard SCR	TO-252

Note: xx = Voltage

### Packing Options

Part Number	Marking	Weight	Packing Mode	Base Quantity
SJxx08DS2TP	SJxx08DS2	0.3 g	Tube	750 (75 per tube)
SJxx08DS2RP	SJxx08DS2	0.3 g	Embossed Carrier	2500
SJxx08VS2TP	SJxx08VS2	0.4 g	Tube	750 (75 per tube)
SJxx08DTP	SJxx08D	0.3 g	Tube	750 (75 per tube)
SJxx08DRP	SJxx08D	0.3 g	Embossed Carrier	2500
SJxx08VTP	SJxx08V	0.4 g	Tube	750 (75 per tube)
SJxx08D1TP	SJxx08D1	0.3 g	Tube	750 (75 per tube)
SJxx08D1RP	SJxx08D1	0.3 g	Embossed Carrier	2500
SJxx08V1TP	SJxx08V1	0.4 g	Tube	750 (75 per tube)

Note: xx = Voltage

**Disclaimer Notice - Information furnished is believed to be accurate and reliable. However, users should independently evaluate the suitability of and test each product selected for their own applications. Littelfuse products are not designed for, and may not be used in, all applications.**

Read complete Disclaimer Notice at [www.littelfuse.com/disclaimer-electronics](http://www.littelfuse.com/disclaimer-electronics).



## X-ON Electronics

Largest Supplier of Electrical and Electronic Components

*Click to view similar products for [SCRs category](#):*

*Click to view products by [Littelfuse manufacturer](#):*

Other Similar products are found below :

[NTE5428](#) [T1500N16TOF VT](#) [TT162N16KOF-A](#) [TT162N16KOF-K](#) [TT330N16AOF](#) [VS-22RIA20](#) [VS-2N685](#) [057219R](#) [T1190N16TOF VT](#)  
[T1220N22TOF VT](#) [T201N70TOH](#) [T700N22TOF](#) [T830N18TOF](#) [TT250N12KOF-K](#) [VS-16RIA120](#) [VS-110RKI40](#) [NTE5427](#) [NTE5442](#)  
[TT251N16KOF-K](#) [VS-22RIA100](#) [VS-16RIA40](#) [TD250N16KOF-A](#) [VS-ST110S16P0](#) [T930N36TOF VT](#) [T2160N24TOF VT](#) [T1190N18TOF](#)  
[VT](#) [T1590N28TOF VT](#) [2N1776A](#) [T590N14TOF](#) [NTE5375](#) [NTE5460](#) [NTE5481](#) [NTE5512](#) [NTE5514](#) [NTE5518](#) [NTE5519](#) [NTE5529](#)  
[NTE5553](#) [NTE5555](#) [NTE5557](#) [NTE5567](#) [NTE5570](#) [NTE5572](#) [NTE5574](#) [NTE5576](#) [NTE5578](#) [NTE5579](#) [NTE5589](#) [NTE5592](#) [NTE5598](#)