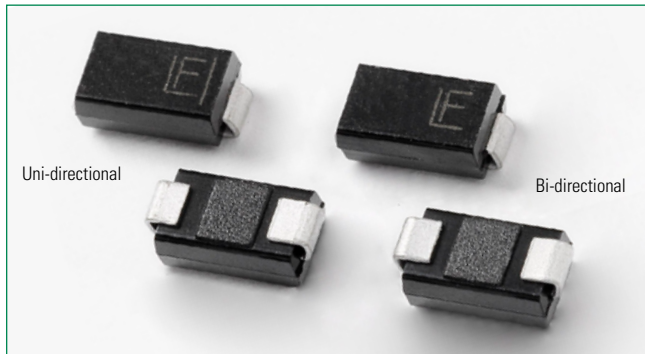


## SMAJ Series



### Agency Approvals

Agency	Agency File Number
	E230531

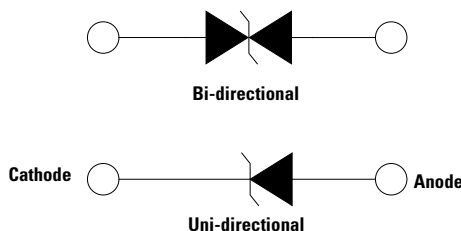
### Maximum Ratings and Thermal Characteristics (T<sub>A</sub> = 25°C unless otherwise noted)

Parameter	Symbol	Value	Unit
Peak Pulse Power Dissipation at TA=25° by 10/1000us Waveform(Fig.2)(Note 1), (Note 2) -Single Die Parts	P <sub>PPM</sub>	400	W
Peak Pulse Power Dissipation at TA=25° by 10/1000us Waveform(Fig.2)(Note 1), (Note 2)-Stacked Die Parts(Note 5)	P <sub>PPM</sub>	600	W
Power Dissipation on Infinite Heat Sink at T <sub>L</sub> =50°C	P <sub>D</sub>	3.3	W
Peak Forward Surge Current, 8.3ms Single Half Sine Wave (Note 3)	I <sub>FSM</sub>	60	A
Maximum Instantaneous Forward Voltage at 25A for Unidirectional Only (Note 4)	V <sub>F</sub>	3.5/5.0	V
Operating Temperature Range	T <sub>J</sub>	-65 to 150	°C
Storage Temperature Range	T <sub>STG</sub>	-65 to 175	°C
Typical Thermal Resistance Junction to Lead	R <sub>θJL</sub>	30	°C/W
Typical Thermal Resistance Junction to Ambient	R <sub>θJA</sub>	120	°C/W

**Notes:**

1. Non-repetitive current pulse, per Fig.4 and derated above T<sub>J</sub> (initial) = 25°C per Fig. 3.
2. Mounted on 5.0x5.0mm copper pad to each terminal.
3. Measured on 8.3ms single half sine wave or equivalent square wave for unidirectional device only.
4. V<sub>F</sub> < 3.5V for single die parts and V<sub>F</sub> < 5.0V for stacked-die parts.
5. For stacked die component details, please refer to part numbers labeled by \* in Electrical Characteristics.

### Functional Diagram



### Description

The SMAJ series is designed specifically to protect sensitive electronic equipment from voltage transients induced by lightning and other transient voltage events.

### Features

- 400W Peak pulse power capability at 10/1000µs waveform, repetition rate (duty cycle): 0.01 %
- Excellent clamping capability
- Typical I<sub>R</sub> less than 1µA when V<sub>BR</sub> min > 12V
- For surface mounted applications to optimize board space
- Low profile package
- Typical failure mode is short from over-specified voltage or current
- Whisker test is conducted based on JEDEC JESD201A per its table 4a and 4c
- IEC-61000-4-2 ESD 30kV(Air), 30kV (Contact)
- ESD protection of data lines in accordance with IEC 61000-4-2
- EFT protection of data lines in accordance with IEC 61000-4-4
- Built-in strain relief
- Fast response time: typically less than 1.0ps from 0 Volts to V<sub>BR</sub> min
- Glass passivated junction
- Low inductance
- High temperature to reflow soldering guaranteed: 260°C/30sec
- V<sub>BR</sub> @ T<sub>J</sub> = V<sub>BR</sub> @ 25°C x (1 + α T x (T<sub>J</sub> - 25)) (α T: Temperature Coefficient, typical value is 0.1%)
- Plastic package is flammability rated V-0 per Underwriters Laboratories
- Meet MSL level1, per J-STD-020, LF maximum peak of 260°C
- Matte tin lead-free Plated
- Halogen free and RoHS compliant
- Pb-free E3 means 2nd level interconnect is Pb-free and the terminal finish material is tin(Sn) (IPC/JEDEC J-STD-609A.01)

### Applications

TVS devices are ideal for the protection of I/O Interfaces, V<sub>CC</sub> bus and other vulnerable circuits used in Telecom, Computer, Industrial and Consumer electronic applications.

### Additional Information



Datasheet



Resources



Samples

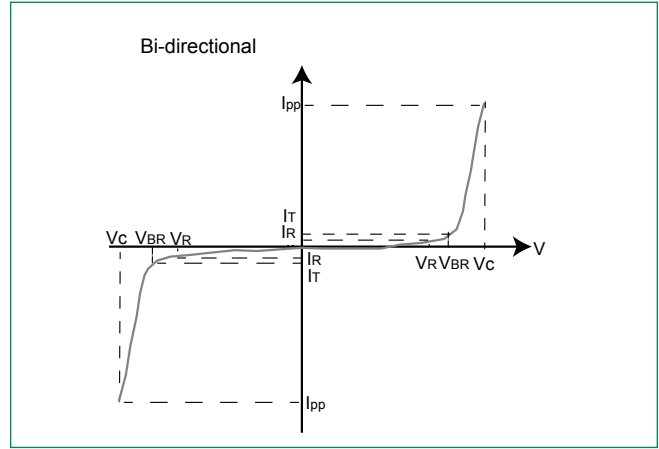
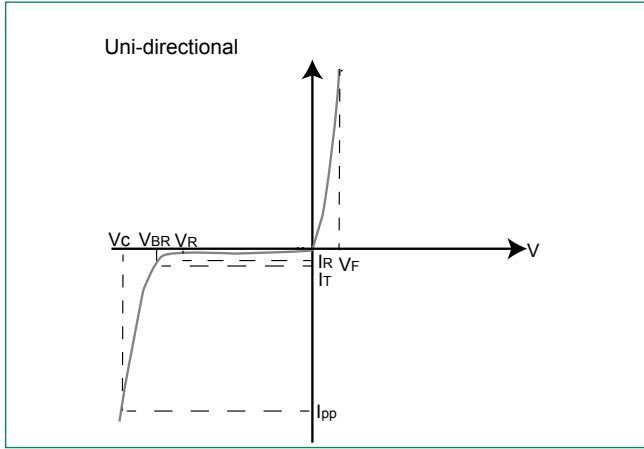
### Electrical Characteristics (T<sub>A</sub> = 25°C unless otherwise noted)

Part Number (Uni)	Part Number (Bi)	Marking		Reverse Stand off Voltage V <sub>R</sub> (Volts)	Breakdown Voltage V <sub>BR</sub> (Volts) @ I <sub>T</sub>		Test Current I <sub>T</sub> (mA)	Maximum Clamping Voltage V <sub>C</sub> @ I <sub>pp</sub> (V)	Maximum Peak Pulse Current I <sub>pp</sub> (A)	Maximum Reverse Leakage I <sub>R</sub> @ V <sub>R</sub> (μA)	Agency Approval 
		Uni.	Bi.		Min.	Max.					
SMAJ5.0A	SMAJ5.0CA	AE	WE	5.0	6.40	7.00	10	9.2	43.5	800	X
SMAJ6.0A	SMAJ6.0CA	AG	WG	6.0	6.67	7.37	10	10.3	38.8	800	X
SMAJ6.5A	SMAJ6.5CA	AK	WK	6.5	7.22	7.98	10	11.2	35.7	500	X
SMAJ7.0A	SMAJ7.0CA	AM	WM	7.0	7.78	8.60	10	12.0	33.3	200	X
SMAJ7.5A	SMAJ7.5CA	AP	WP	7.5	8.33	9.21	1	12.9	31.0	100	X
SMAJ8.0A	SMAJ8.0CA	AR	WR	8.0	8.89	9.83	1	13.6	29.4	50	X
SMAJ8.5A	SMAJ8.5CA	AT	WT	8.5	9.44	10.40	1	14.4	27.8	20	X
SMAJ9.0A	SMAJ9.0CA	AV	WV	9.0	10.00	11.10	1	15.4	26.0	10	X
SMAJ10A	SMAJ10CA	AX	WX	10.0	11.10	12.30	1	17.0	23.5	5	X
SMAJ11A	SMAJ11CA	AZ	WZ	11.0	12.20	13.50	1	18.2	22.0	1	X
SMAJ12A	SMAJ12CA	BE	XE	12.0	13.30	14.70	1	19.9	20.1	1	X
SMAJ13A	SMAJ13CA	BG	XG	13.0	14.40	15.90	1	21.5	18.6	1	X
SMAJ14A	SMAJ14CA	BK	XK	14.0	15.60	17.20	1	23.2	17.2	1	X
SMAJ15A	SMAJ15CA	BM	XM	15.0	16.70	18.50	1	24.4	16.4	1	X
SMAJ16A	SMAJ16CA	BP	XP	16.0	17.80	19.70	1	26.0	15.4	1	X
SMAJ17A	SMAJ17CA	BR	XR	17.0	18.90	20.90	1	27.6	14.5	1	X
SMAJ18A	SMAJ18CA	BT	XT	18.0	20.00	22.10	1	29.2	13.7	1	X
SMAJ20A	SMAJ20CA	BV	XV	20.0	22.20	24.50	1	32.4	12.3	1	X
SMAJ22A	SMAJ22CA	BX	XX	22.0	24.40	26.90	1	35.5	11.3	1	X
SMAJ24A	SMAJ24CA	BZ	XZ	24.0	26.70	29.50	1	38.9	10.3	1	X
SMAJ26A	SMAJ26CA	CE	YE	26.0	28.90	31.90	1	42.1	9.5	1	X
SMAJ28A	SMAJ28CA	CG	YG	28.0	31.10	34.40	1	45.4	8.8	1	X
SMAJ30A	SMAJ30CA	CK	YK	30.0	33.30	36.80	1	48.4	8.3	1	X
SMAJ33A	SMAJ33CA	CM	YM	33.0	36.70	40.60	1	53.3	7.5	1	X
SMAJ36A	SMAJ36CA	CP	YP	36.0	40.00	44.20	1	58.1	6.9	1	X
SMAJ40A	SMAJ40CA	CR	YR	40.0	44.40	49.10	1	64.5	6.2	1	X
SMAJ43A	SMAJ43CA	CT	YT	43.0	47.80	52.80	1	69.4	5.8	1	X
SMAJ45A	SMAJ45CA	CV	YV	45.0	50.00	55.30	1	72.7	5.5	1	X
SMAJ48A	SMAJ48CA	CX	YX	48.0	53.30	58.90	1	77.4	5.2	1	X
SMAJ51A	SMAJ51CA	CZ	YZ	51.0	56.70	62.70	1	82.4	4.9	1	X
SMAJ54A	SMAJ54CA	RE	ZE	54.0	60.00	66.30	1	87.1	4.6	1	X
SMAJ58A	SMAJ58CA	RG	ZG	58.0	64.40	71.20	1	93.6	4.3	1	X
SMAJ60A	SMAJ60CA	RK	ZK	60.0	66.70	73.70	1	96.8	4.1	1	X
SMAJ64A	SMAJ64CA	RM	ZM	64.0	71.10	78.60	1	103.0	3.9	1	X
SMAJ70A	SMAJ70CA	RP	ZP	70.0	77.80	86.00	1	113.0	3.5	1	X
SMAJ75A	SMAJ75CA	RR	ZR	75.0	83.30	92.10	1	121.0	3.3	1	X
SMAJ78A	SMAJ78CA	RT	ZT	78.0	86.70	95.80	1	126.0	3.2	1	X
SMAJ85A	SMAJ85CA	RV	ZV	85.0	94.40	104.00	1	137.0	2.9	1	X
SMAJ90A	SMAJ90CA	RX	ZX	90.0	100.00	111.00	1	146.0	2.7	1	X
SMAJ100A	SMAJ100CA	RZ	ZZ	100.0	111.00	123.00	1	162.0	2.5	1	X
SMAJ110A	SMAJ110CA	SE	VE	110.0	122.00	135.00	1	177.0	2.3	1	X
SMAJ120A	SMAJ120CA	SG	VG	120.0	133.00	147.00	1	193.0	2.1	1	X
SMAJ130A	SMAJ130CA	SK	VK	130.0	144.00	159.00	1	209.0	1.9	1	X
SMAJ150A	SMAJ150CA	SM	VM	150.0	167.00	185.00	1	243.0	1.6	1	X
SMAJ160A	SMAJ160CA	SP	VP	160.0	178.00	197.00	1	259.0	1.5	1	X
SMAJ170A	SMAJ170CA	SR	VR	170.0	189.00	209.00	1	275.0	1.5	1	X
SMAJ180A	SMAJ180CA	ST	VT	180.0	201.00	222.00	1	292.0	1.4	1	-
SMAJ188A	SMAJ188CA	SB	VB	188.0	209.00	231.00	1	304.0	1.4	1	-
SMAJ200A	SMAJ200CA	SV	VV	200.0	224.00	247.00	1	324.0	1.2	1	-
SMAJ220A	-	SX	-	220.0	246.00	272.00	1	356.0	1.1	1	-
-	SMAJ220CA*	-	VX	220.0	246.00	272.00	1	356.0	1.7	1	-
SMAJ250A	-	SZ	-	250.0	279.00	309.00	1	405.0	1.0	1	-
-	SMAJ250CA*	-	VZ	250.0	279.00	309.00	1	405.0	1.5	1	-
SMAJ300A*	SMAJ300CA*	TE	UE	300.0	335.00	371.00	1	486.0	1.3	1	-
SMAJ350A*	SMAJ350CA*	TG	UG	350.0	391.00	432.00	1	567.0	1.1	1	-
SMAJ400A*	SMAJ400CA*	TK	UK	400.0	447.00	494.00	1	648.0	1.0	1	-
SMAJ440A*	SMAJ440CA*	TM	UM	440.0	492.00	543.00	1	713.0	0.9	1	-

**Notes:**

For bidirectional type having V<sub>C</sub> of 10 volts and less, the I<sub>n</sub> limit is double.  
 For stack-die parts, use \* to label the part number.

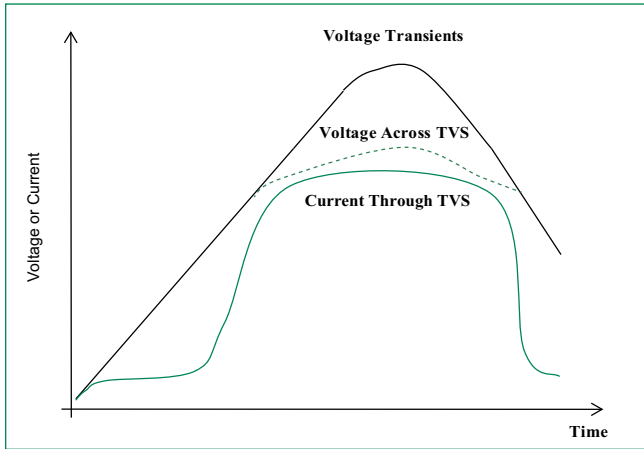
**I-V Curve Characteristics**



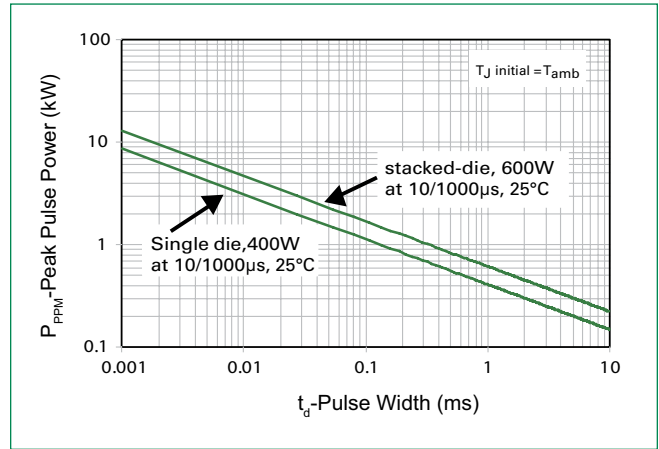
- $P_{PPM}$**  Peak Pulse Power Dissipation – Max power dissipation
- $V_R$**  Stand-off Voltage – Maximum voltage that can be applied to the TVS without operation
- $V_{BR}$**  Breakdown Voltage – Maximum voltage that flows through the TVS at a specified test current ( $I_T$ )
- $V_C$**  Clamping Voltage – Peak voltage measured across the TVS at a specified  $I_{ppm}$  (peak impulse current)
- $I_R$**  Reverse Leakage Current – Current measured at  $V_R$
- $V_F$**  Forward Voltage Drop for Uni-directional

**Ratings and Characteristic Curves** ( $T_A=25^\circ\text{C}$  unless otherwise noted)

**Figure 1 - TVS Transients Clamping Waveform**

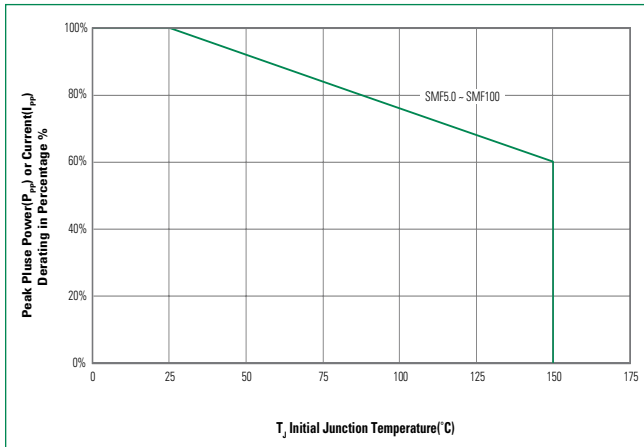


**Figure 2 - Peak Pulse Power Rating Curve**

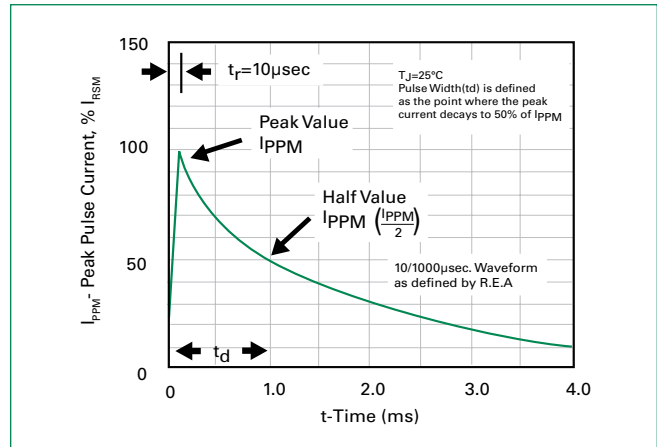


**Ratings and Characteristic Curves** ( $T_A=25^\circ\text{C}$  unless otherwise noted) (Continued)

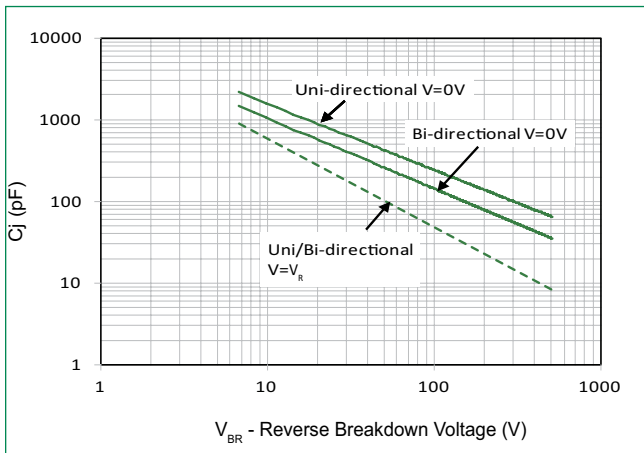
**Figure 3 - Peak Pulse Power Derating Curve**



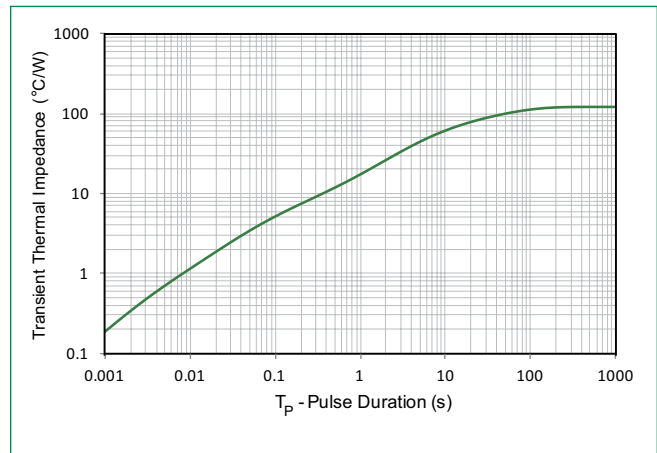
**Figure 4 - Pulse Waveform**



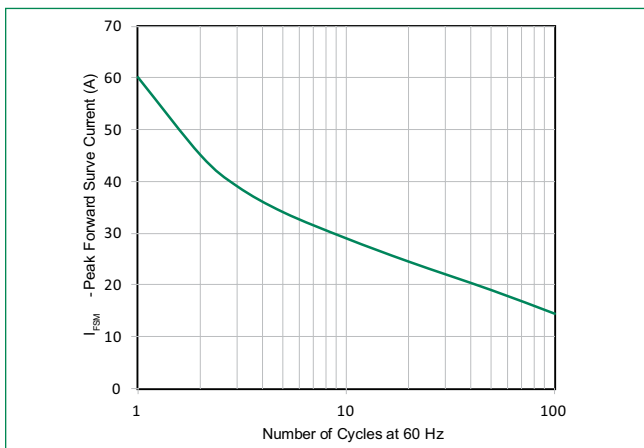
**Figure 5 - Typical Junction Capacitance**



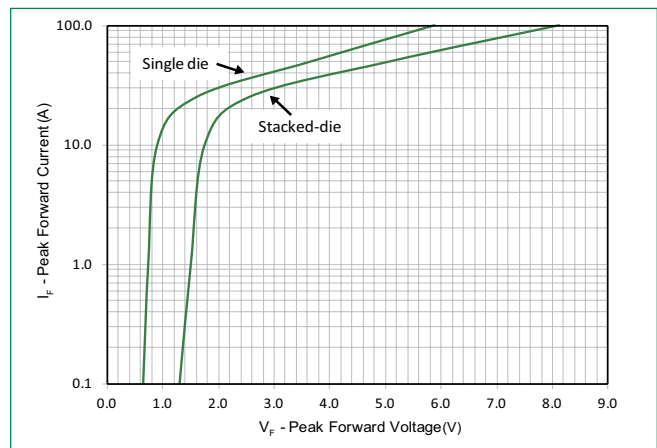
**Figure 6 - Typical Transient Thermal Impedance**



**Figure 7 - Maximum Non-Repetitive Forward Surge Current Uni-Directional Only**

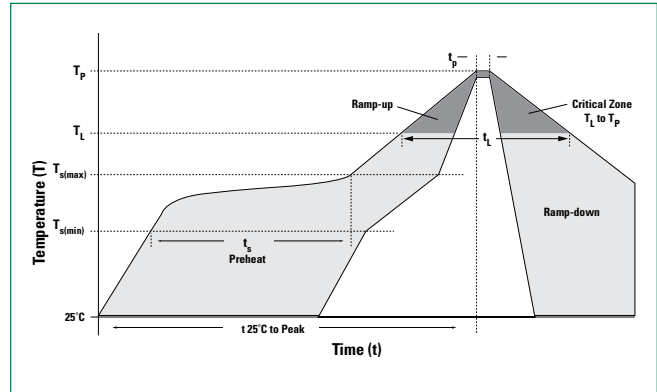


**Figure 8 - Peak Forward Voltage Drop vs Peak Forward Current (Typical Values)**



**Soldering Parameters**

<b>Reflow Condition</b>		Lead-free assembly
<b>Pre Heat</b>	- Temperature Min ( $T_{s(min)}$ )	150°C
	- Temperature Max ( $T_{s(max)}$ )	200°C
	- Time (min to max) ( $t_s$ )	60 – 120 secs
<b>Average ramp up rate (Liquidus Temp (<math>T_L</math>) to peak</b>		3°C/second max
<b><math>T_{s(max)}</math> to <math>T_L</math> - Ramp-up Rate</b>		3°C/second max
<b>Reflow</b>	- Temperature ( $T_L$ ) (Liquidus)	217°C
	- Time (min to max) ( $t_L$ )	60 – 150 seconds
<b>Peak Temperature (<math>T_p</math>)</b>		260 <sup>+0/-5</sup> °C
<b>Time within 5°C of actual peak Temperature (<math>t_p</math>)</b>		30 seconds Max
<b>Ramp-down Rate</b>		6°C/second Max
<b>Time 25°C to peak Temperature (<math>T_p</math>)</b>		8 minutes Max.
<b>Do not exceed</b>		260°C



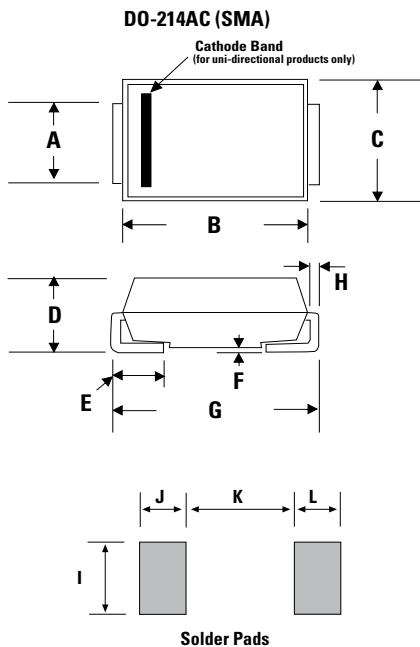
**Physical Specifications**

<b>Weight</b>	0.002 ounce, 0.061 gram
<b>Case</b>	JEDEC DO-214AC Molded Plastic over glass passivated junction
<b>Polarity</b>	Color band denotes cathode except Bipolar
<b>Terminal</b>	Matte Tin-plated leads, Solderable per JESD22-B102

**Environmental Specifications**

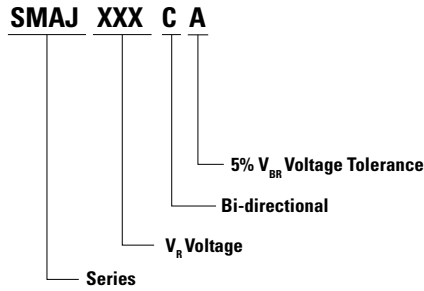
<b>High Temp. Storage</b>	JESD22-A103
<b>HTRB</b>	JESD22-A108
<b>Temperature Cycling</b>	JESD22-A104
<b>MSL</b>	JEDEC-J-STD-020, Level 1
<b>H3TRB</b>	JESD22-A101
<b>RSH</b>	JESD22-A111

**Dimensions**

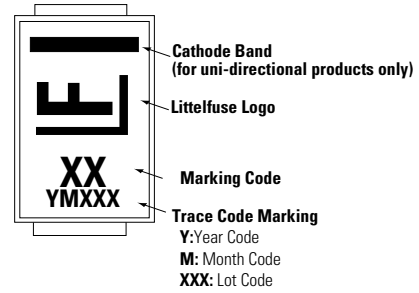


Dimensions	Inches		Millimeters	
	Min	Max	Min	Max
A	0.049	0.065	1.250	1.650
B	0.157	0.181	3.990	4.600
C	0.095	0.110	2.400	2.790
D	0.075	0.090	1.900	2.290
E	0.030	0.060	0.780	1.520
F	-	0.008	-	0.203
G	0.189	0.208	4.800	5.280
H	0.006	0.012	0.152	0.305
I	0.070	-	1.800	-
J	0.082	-	2.100	-
K	-	0.090	-	2.300
L	0.082	-	2.100	-

### Part Numbering System



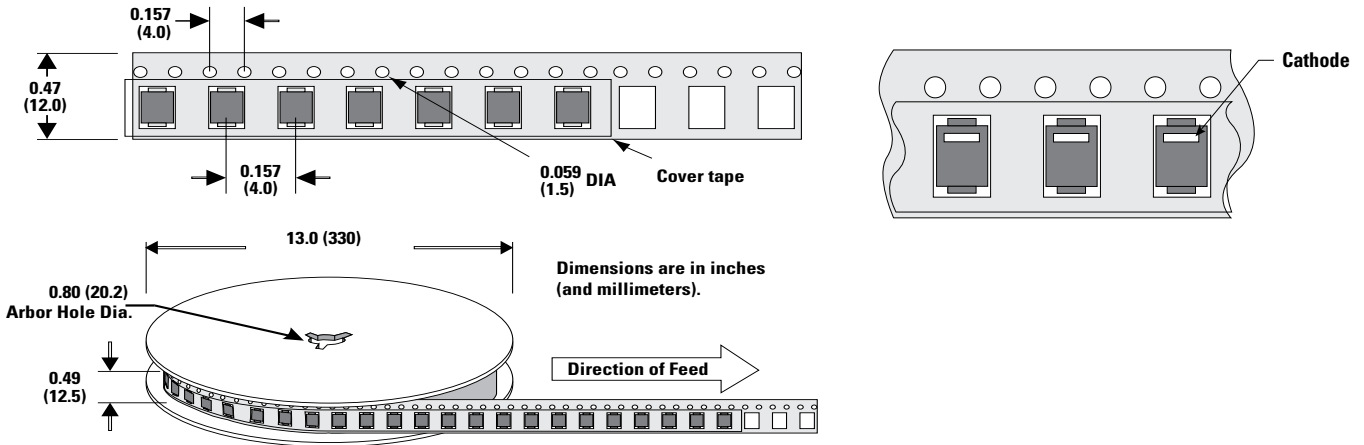
### Part Marking System



### Packaging

Part number	Component Package	Quantity	Packaging Option	Packaging Specification
SMAJ-xxxXX	DO-214AC	5000	Tape & Reel - 12mm tape/13" reel	EIA STD RS-481

### Tape and Reel Specification



## X-ON Electronics

Largest Supplier of Electrical and Electronic Components

*Click to view similar products for [ESD Suppressors / TVS Diodes](#) category:*

*Click to view products by [Littelfuse](#) manufacturer:*

Other Similar products are found below :

[60KS200C](#) [D12V0H1U2WS-7](#) [D18V0L1B2LP-7B](#) [82356050220](#) [D5V0F4U5P5-7](#) [D5V0M5U6V-7](#) [NTE4902](#) [P4KE27CA](#) [P6KE11CA](#)  
[P6KE39CA-TP](#) [P6KE8.2A](#) [SA110CA](#) [SA60CA](#) [SA64CA](#) [SMBJ12CATR](#) [SMBJ8.0A](#) [SMLJ30CA-TP](#) [ESD112-B1-02EL E6327](#)  
[ESD119B1W01005E6327XTSA1](#) [ESD5V0J4-TP](#) [ESD5V0L1B02VH6327XTSA1](#) [ESD7451N2T5G](#) [19180-510](#) [CPDT-5V0USP-HF](#)  
[3.0SMCJ33CA-F](#) [3.0SMCJ36A-F](#) [HSPC16701B02TP](#) [D3V3Q1B2DLP3-7](#) [D55V0M1B2WS-7](#) [DESD5V0U1BL-7B](#) [DRTR5V0U4SL-7](#)  
[SCM1293A-04SO](#) [ESD203-B1-02EL E6327](#) [SM12-7](#) [SMF8.0A-TP](#) [SMLJ45CA-TP](#) [CEN955 W/DATA](#) [82350120560](#) [82356240030](#)  
[VESD12A1A-HD1-GS08](#) [CPDUR5V0R-HF](#) [CPDUR24V-HF](#) [CPDQC5V0U-HF](#) [CPDQC5V0USP-HF](#) [CPDQC5V0-HF](#) [D1213A-01LP4-7B](#)  
[D1213A-02WL-7](#) [ESDLIN1524BJ-HQ](#) [5KP100A](#) [5KP15A](#)