

SP0502B Series 1pF 15kV Diode Arrays



Description

The SP0502B is a low capacitance TVS diode array designed to protect high-speed data interfaces from over-voltage caused by ESD (electrostatic discharge), CDE (Cable Discharge Events), and EFT (electrical fast transients). It has a typical capacitance of only 0.3pF (pin 1 to 2) making it suitable for use on circuits operating in excess of 3GHz without signal attenuation.

The SP0502BXTG is in a small SOT-523 package and each device can be configured to protect 1 bidirectional line or two unidirectional lines. The combination of small size, ultra-low capacitance, and high level of ESD protection makes it an ideal solution for applications such as HDMI, USB, MDDI, antennas, and DisplayPort.

Functional Block Diagram and Pinout

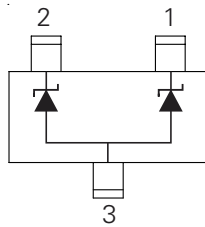

Life Support Note:

Not Intended for Use in Life Support or Life Saving Applications

The products shown herein are not designed for use in life sustaining or life saving applications unless otherwise expressly indicated.

Features

- RoHS compliant and lead-free
- ESD protection of ±15kV contact discharge, ±20kV air discharge, (IEC 61000-4-2)
- EFT, IEC 61000-4-4, 40A (5/50ns)
- Lightning protection, IEC 61000-4-5 2nd edition, 2A ($t_p=8/20\mu s$)
- Stand-off voltage of 5V
- Low capacitance of 1pF @ $V_R=0V$ (MAX)
- Low leakage current of 0.5µA at 5V (MAX)
- Small form factor (SOT523) and low profile (<1mm)
- No insertion loss to >3.0GHz

Additional Information



Datasheet



Resources



Samples

Applications

- High-Definition Multimedia Interface (HDMI)
- Mobile Display Digital Interface (MDDI)
- RF/Antenna Circuits
- USB 2.0
- DisplayPort
- Mobile - Smartphone, Tablet, Notebook

Absolute Maximum Ratings

Symbol	Parameter	Value	Units
P_{PK}	Peak Pulse Power ($t_p=8/20\mu s$)	25	W
I_{PP}	Peak Pulse Current ($t_p=8/20\mu s$)	2	A
T_{OP}	Operating Temperature	-40 to 125	°C
T_{STOR}	Storage Temperature	-55 to 150	°C

CAUTION: Stresses above those listed in "Absolute Maximum Ratings" may cause permanent damage to the device. This is a stress only rating and operation of the device at these or any other conditions above those indicated in the operational sections of this specification is not implied.

Thermal Information

Parameter	Rating	Units
Storage Temperature Range	-55 to 150	°C
Maximum Junction Temperature	150	°C
Maximum Lead Temperature (Soldering 20-40s)	260	°C

Electrical Characteristics ($T_{OP} = 25^\circ C$)

Parameter	Symbol	Test Conditions	Min	Typ	Max	Units
Reverse Standoff Voltage	V_{RWM}	$I_R \leq 1\mu A$, Pin1 or Pin2 to Pin3 and Pin1 to Pin2			5.0	V
Reverse Breakdown Voltage	V_{BR}	$I_t = 1mA$, Pin1 or Pin2 to Pin3	6			V
Leakage Current	I_{LEAK}	$V_R = 5V$			0.5	μA
Clamp Voltage ¹	V_C	$I_{PP} = 1A$, $t_p = 8/20\mu s$, Pin 1 to Pin 2			12	V
Dynamic Resistance ²	R_{DYN}	TLP, $t_p = 100ns$, I/O to GND		0.45		Ω
ESD Withstand Voltage ¹	V_{ESD}	IEC 61000-4-2 (Contact Discharge)	± 15			kV
		IEC 61000-4-2 (Air Discharge)	± 20			kV
Diode Capacitance ¹	$C_{I/O-I/O}$	Reverse Bias=0V, $f=1MHz$; Pin 1 to Pin2		0.25	0.5	pF
	$C_{I/O-GND}$	Reverse Bias=0V, $f=1MHz$; Pin 1 or Pin2 to Pin 3			1.0	pF

Note:

1 Parameter is guaranteed by design and/or device characterization.

2 Transmission Line Pulse (TLP) with 100ns width and 200ps rise time.

Pulse Waveform

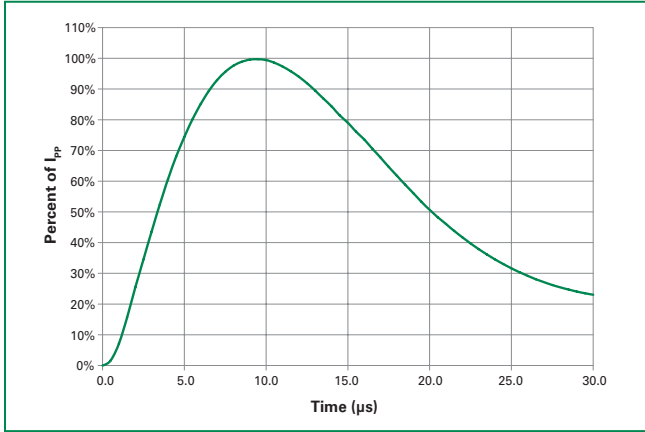

Insertion Loss of Pin 1 to Pin 2 (I/O to I/O)

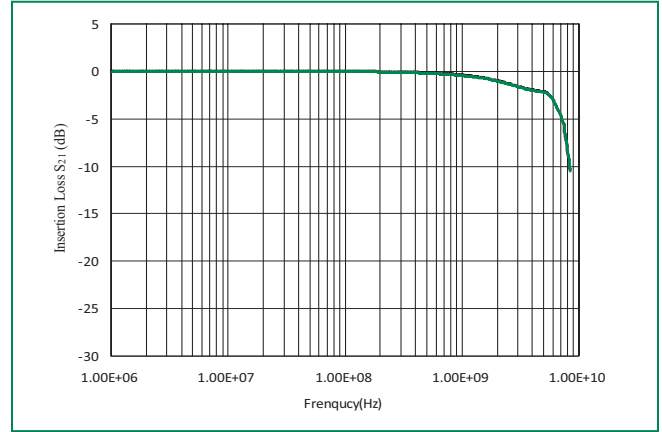

Capacitance vs. Reverse Bias (Pin 1 or Pin 2 to Pin 3)

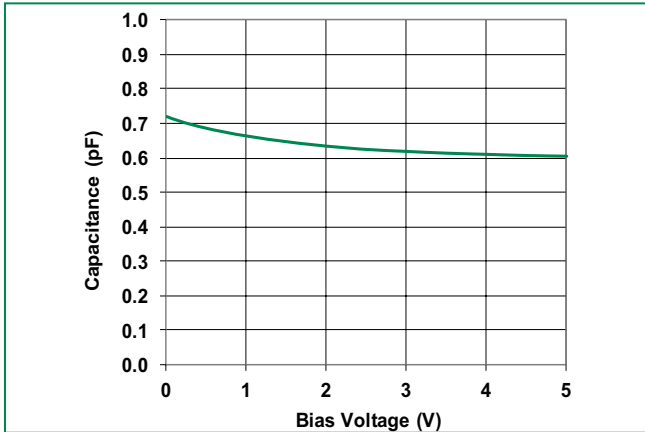

Capacitance vs. Reverse Bias (I/O-I/O) (Pin 1 to Pin 2)

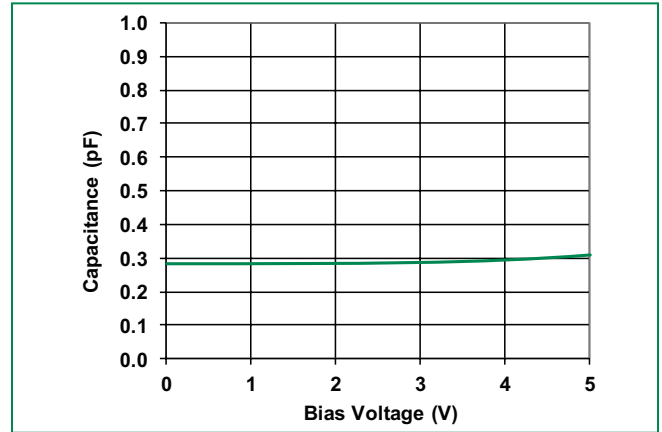

Transmission Line Pulse (TLP)

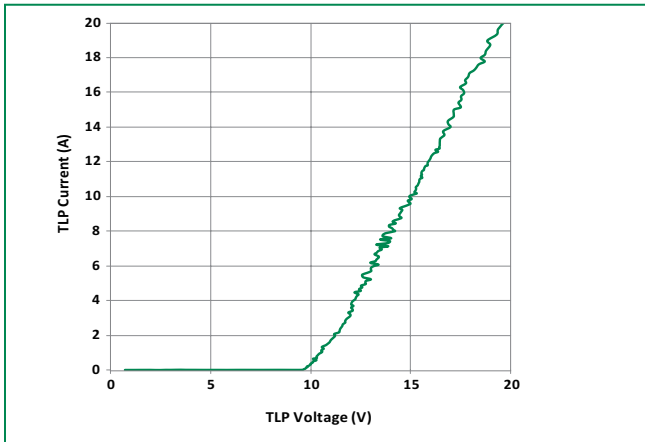

Product Characteristics

Lead Plating	Pre-Plated Frame
Lead Material	Copper Alloy
Lead Coplanarity	0.0004 inches (0.102mm)
Substrate material	Silicon
Body Material	Molded Epoxy
Flammability	UL 94 V-0

Notes :

1. All dimensions are in millimeters
2. Dimensions include solder plating.
3. Dimensions are exclusive of mold flash & metal burr.
4. Blo is facing up for mold and facing down for trim/form, i.e. reverse trim/form.
5. Package surface matte finish VDI 11-13.

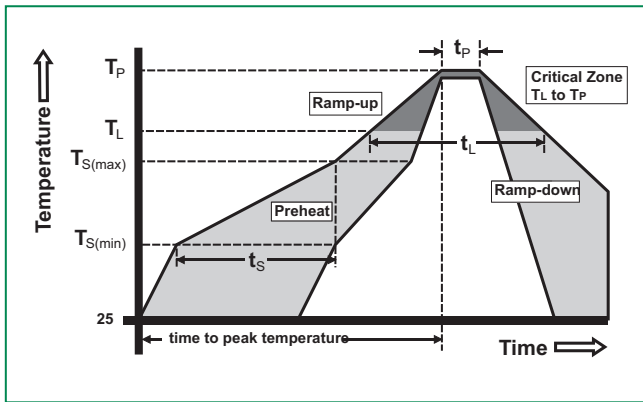

Soldering Parameters

Reflow Condition	Pb – Free assembly	
Pre Heat	- Temperature Min ($T_{s(min)}$)	150°C
	- Temperature Max ($T_{s(max)}$)	200°C
	- Time (min to max) (t_s)	60 – 180 secs
Average ramp up rate (Liquidus) Temp (T_L) to peak	3°C/second max	
$T_{s(max)}$ to T_L - Ramp-up Rate	3°C/second max	
Reflow	- Temperature (T_L) (Liquidus)	217°C
	- Temperature (t_L)	60 – 150 seconds
Peak Temperature (T_P)	260 ^{+0/-5} °C	
Time within 5°C of actual peak Temperature (t_p)	20 – 40 seconds	
Ramp-down Rate	6°C/second max	
Time 25°C to peak Temperature (T_P)	8 minutes Max.	
Do not exceed	260°C	

Ordering Information

Part Number	Package	Size	Marking	Min. Order Qty.
SP0502BXTG	SOT523	1.6x1.6mm	3**	3000

Part Numbering System

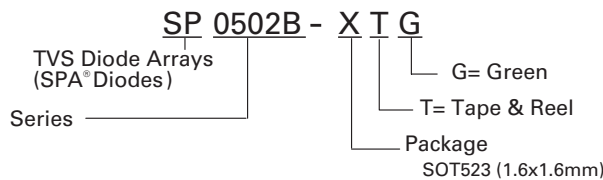

Part Marking System

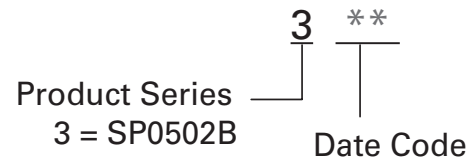

Package Dimensions – SOT523

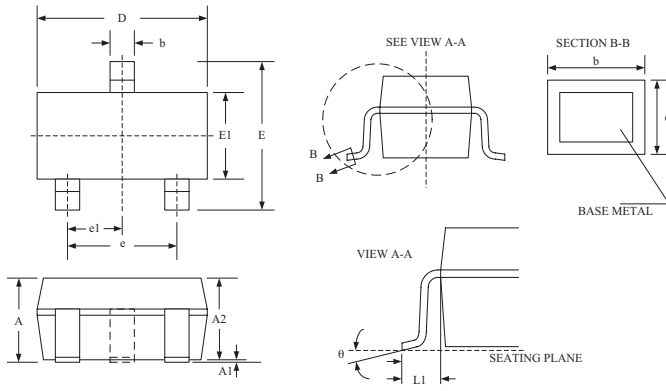

	Millimetres			Inches		
	Min	Typ	Max	Min	Typ	Max
A	0.60	-	0.90	0.023	-	0.035
A1	0.00	-	0.10	0.000	-	0.004
A2	0.60	0.75	0.80	0.023	0.030	0.031
b	0.15	-	0.30	0.005	-	0.012
c	0.10	-	0.20	0.003	-	0.008
D	1.50	1.60	1.70	0.059	0.063	0.067
e	1.00 BSC			0.039 BSC		
e1	0.50 BSC			0.020 BSC		
E	1.45	1.60	1.75	0.057	0.063	0.069
E1	0.75	0.80	0.85	0.029	0.031	0.033
L1	0.22 REF			0.009 RFE		
θ	0°	-	8°	0°	-	8°

Embossed Carrier Tape & Reel Specification – SOT523

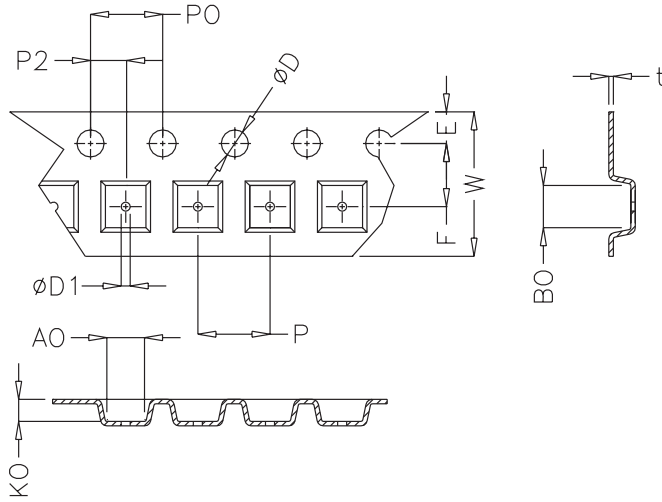

	Millimetres		Inches	
	Min	Max	Min	Max
E	1.65	1.85	0.065	0.073
F	3.45	3.55	0.135	0.139
P2	1.95	2.05	0.077	0.081
D	1.40	1.60	0.055	0.063
D1	0.45	0.55	0.017	0.021
P0	3.90	4.10	0.154	0.161
10P0	40.0+/- 0.20		1.574+/-0.008	
W	7.70	8.10	0.303	0.318
P	3.90	4.10	0.153	0.161
A0	1.73	1.83	0.068	0.072
BO	1.73	1.83	0.068	0.072
K0	0.64	0.74	0.025	0.029
t	0.22 max		0.009 max	

X-ON Electronics

Largest Supplier of Electrical and Electronic Components

Click to view similar products for [ESD Suppressors / TVS Diodes](#) category:

Click to view products by [Littelfuse](#) manufacturer:

Other Similar products are found below :

[60KS200C](#) [D12V0H1U2WS-7](#) [D18V0L1B2LP-7B](#) [82356050220](#) [D5V0M5U6V-7](#) [NTE4902](#) [P4KE27CA](#) [P6KE11CA](#) [P6KE39CA-TP](#)
[P6KE8.2A](#) [SA110CA](#) [SA60CA](#) [SA64CA](#) [SMBJ12CATR](#) [SMBJ8.0A](#) [SMLJ30CA-TP](#) [ESD112-B1-02EL](#) [E6327](#)
[ESD119B1W01005E6327XTSA1](#) [ESD5V0J4-TP](#) [ESD5V0L1B02VH6327XTSA1](#) [ESD7451N2T5G](#) [19180-510](#) [CPDT-5V0USP-HF](#)
[3.0SMCJ33CA-F](#) [3.0SMCJ36A-F](#) [HSPC16701B02TP](#) [D3V3Q1B2DLP3-7](#) [D55V0M1B2WS-7](#) [DESD5V0U1BL-7B](#) [DRTR5V0U4SL-7](#)
[SCM1293A-04SO](#) [ESD203-B1-02EL](#) [E6327](#) [SM12-7](#) [SMF8.0A-TP](#) [SMLJ45CA-TP](#) [CEN955 W/DATA](#) [82350120560](#) [82356240030](#)
[VESD12A1A-HD1-GS08](#) [CPDUR5V0R-HF](#) [CPDUR24V-HF](#) [CPDQC5V0U-HF](#) [CPDQC5V0USP-HF](#) [CPDQC5V0-HF](#) [D1213A-01LP4-7B](#)
[D1213A-02WL-7](#) [ESDLIN1524BJ-HQ](#) [5KP100A](#) [5KP15A](#) [5KP18A](#)