

Ultra Low Capacitance Diode Arrays Series

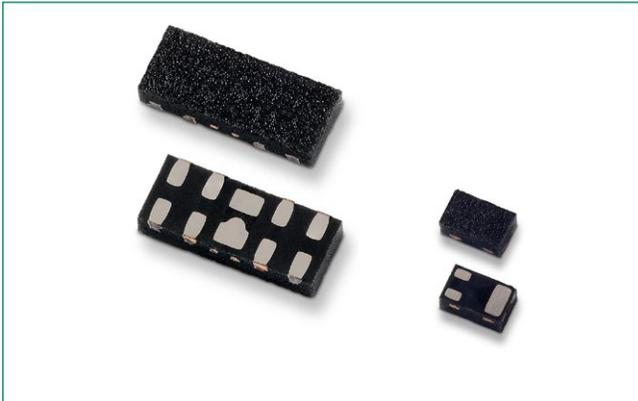

Pinout

0402 DFN array

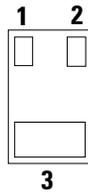

1004 DFN array

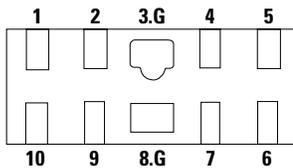

Functional Block Diagram

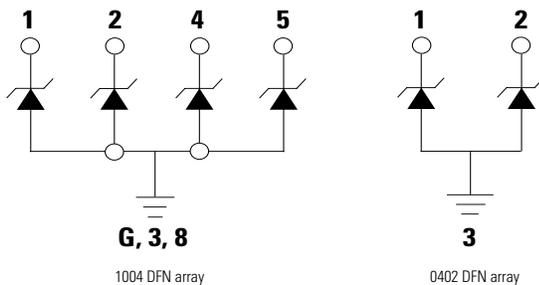

Description

This Ultra Low Capacitance Diode Arrays Series provides signal integrity-preserving unidirectional ESD protection for the world's most challenging high speed serial interfaces. The SOD 883 and the standard 2.4 mm x 1.0 mm packaging options provide significant PCB layout space savings and reduces trace layout complexity. This component provides both air and contact ESD protection (IEC 61000-4-2) of 20 kV while maintaining an extremely low leakage current and low dynamic resistance. Due to its low off-state capacitance, this series is compatible with high speed interfaces and thus maintains high bandwidth signal integrity.

Features

- 0.20 pF TYP capacitance
- ESD, IEC 61000-4-2, ±20kV contact, ±20kV air
- Low clamping voltage of 9.2V @ I_{pp}=2.0A (t_p=8/20µs)
- Low profile DFN array packages
- Facilitates excellent signal integrity
- ELV Compliant
- Halogen free, Lead free and RoHS compliant
- AEC-Q101 qualified (0402 DFN array)

Applications

- USB 3.1, 3.0, 2.0
- HDMI 2.0, 1.4a, 1.3
- DisplayPort™
- V-by-One®
- Thunderbolt (Light Peak)
- LVDS interfaces
- Consumer, mobile and portable electronics
- Tablet PC and external storage with high speed interfaces
- Applications requiring high ESD performance in small packages

Absolute Maximum Ratings

Symbol	Parameter	Value	Units
I_{PP}	Peak Current ($t_p=8/20\mu s$)	2.0	A
T_{OP}	Operating Temperature	-40 to 125	°C
T_{STOR}	Storage Temperature	-55 to 150	°C

CAUTION: Stresses above those listed in "Absolute Maximum Ratings" may cause permanent damage to the component. This is a stress only rating and operation of the component at these or any other conditions above those indicated in the operational sections of this specification is not implied.

Electrical Characteristics - ($T_{OP}=25^\circ C$)

Parameter	Test Conditions	Min	Typ	Max	Units
Input Capacitance	@ $V_R = 0V, f = 3GHz$		0.20	0.22	pF
Breakdown Voltage	$V_{BR} @ I_T=1mA$		9.00		V
Reverse Working Voltage				7.0	V
Reverse Leakage Current	$I_L @ V_{RWM}=5.0V$		25	50	nA
Clamping Voltage	$V_{CL} @ I_{PP}=2.0A$		9.20		V
Peak Pulse Current	$t_p=8/20\mu s$			2.0	A
ESD Withstand Voltage	IEC 61000-4-2 (Contact)	±20			kV
	IEC 61000-4-2 (Air)	±20			

Insertion Loss Diagram

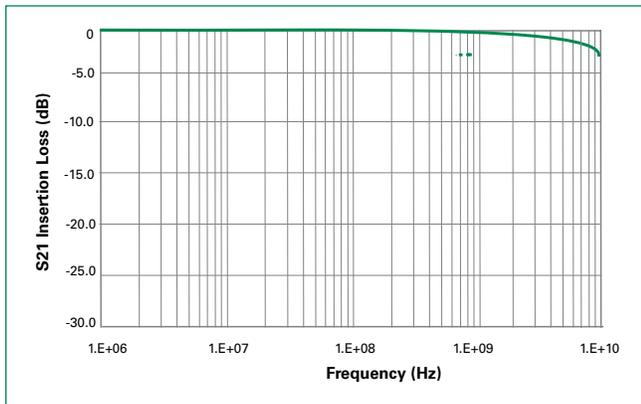

Device IV Curve

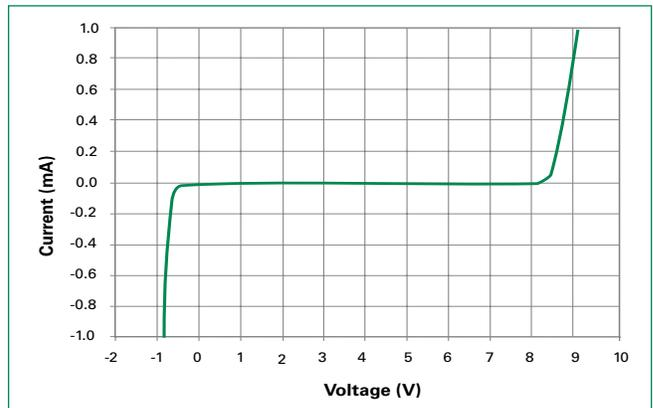

TLP

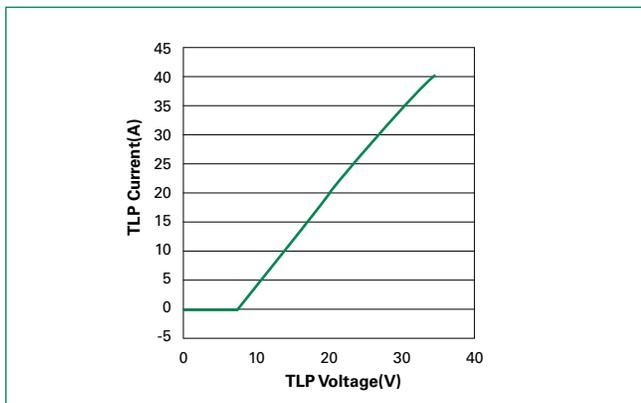

USB3.0 Eye Diagram

5.0 Gb/s, 1000mV differential, CPO Compliant Test Pattern

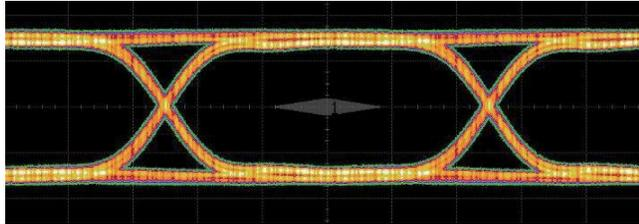

Without Component

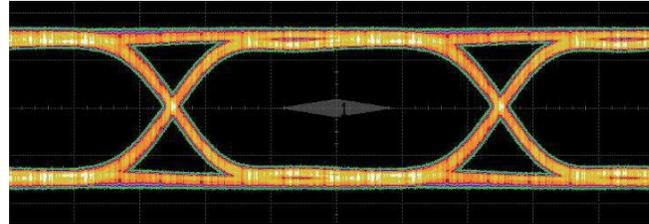

With Component

Soldering Parameters

Reflow Condition		Pb – Free assembly
Pre Heat	- Temperature Min ($T_{s(min)}$)	150°C
	- Temperature Max ($T_{s(max)}$)	200°C
	- Time (min to max) (t_s)	60 – 180 secs
Average ramp up rate (Liquidus) Temp (T_L) to peak		3°C/second max
$T_{S(max)}$ to T_L - Ramp-up Rate		3°C/second max
Reflow	- Temperature (T_L) (Liquidus)	217°C
	- Temperature (t_L)	60 – 150 seconds
Peak Temperature (T_p)		260 ^{+0/-5} °C
Time within 5°C of actual peak Temperature (t_p)		20 – 40 seconds
Ramp-down Rate		6°C/second max
Time 25°C to peak Temperature (T_p)		8 minutes Max.
Do not exceed		260°C

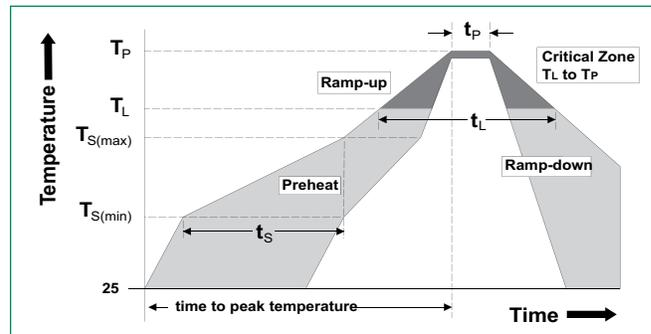

Part Numbering System

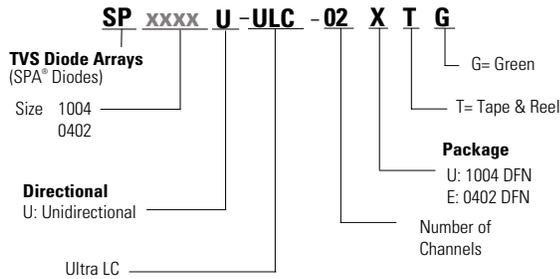

Product Characteristics of 0402 DFN Package

Lead Plating	Pre-Plated Frame
Lead Material	Copper Alloy
Lead Coplanarity	0.004 inches(0.102mm)
Substrate material	Silicon
Body Material	Molded Epoxy
Flammability	UL Recognized epoxy meeting flammability rating V-0.

- Notes :
1. All dimensions are in millimeters
 2. Dimensions include solder plating.
 3. Dimensions are exclusive of mold flash & metal burr.
 4. Blo is facing up for mold and facing down for trim/form, i.e. reverse trim/form.
 5. Package surface matte finish VDI 11-13.

Part Marking System



0402

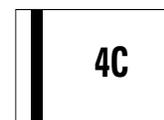

1004

Notes :
For markings see Ordering Information table below

Ordering Information

Part Number	Package	Reel Quantity
SP0402U-ULC-02ETG	0402 DFN Array	10000
SP1004U-ULC-04UTG	1004 DFN Array	3000

Package Dimensions — 0402 DFN Array

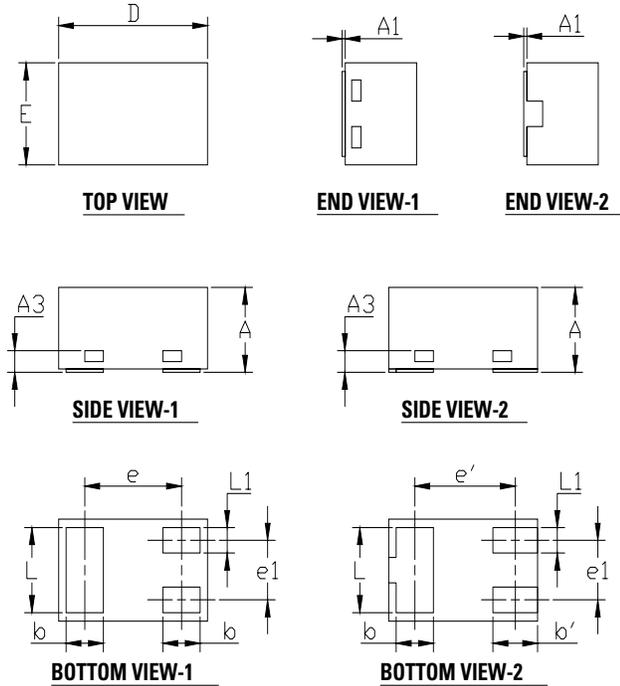

Symbol	Millimeters			Inches		
	Min	Typ	Max	Min	Typ	Max
A	0.33	-	0.55	0.013	0.015	0.022
A1	0	-	0.05	0	-	0.002
A3	0.13REF			0.005REF		
b	0.20	0.25	0.30	0.008	0.010	0.012
b'	0.20	0.30	0.40	0.008	0.012	0.016
D	0.95	1.00	1.05	0.037	0.039	0.041
E	0.55	0.60	0.65	0.022	0.024	0.026
e	0.65BSC			0.026BSC		
e'	0.675BSC			0.027BSC		
L	0.40	0.50	0.60	0.016	0.020	0.024
L1	0.10	0.15	0.20	0.004	0.006	0.008

SOLDERING PATTERN

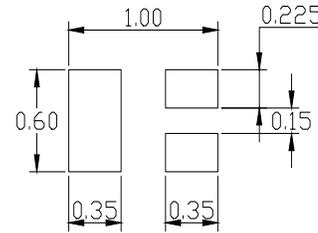

Embossed Carrier Tape & Reel Specification — 0402 DFN Array

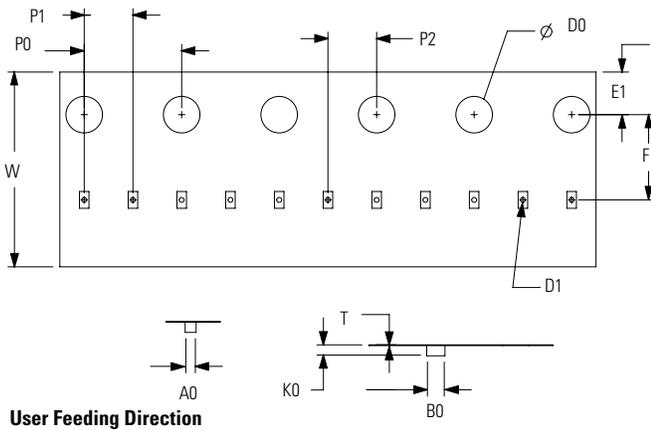

Symbol	Millimeters
A0	0.70+/-0.05
B0	1.15+/-0.05
D0	∅ 1.50+/-0.10
D1	∅ 0.40 +/-0.10
E1	1.75+/-0.10
F	3.50+/-0.10
K0	0.55+/-0.05
P0	4.00+/-0.10
P1	2.00+/-0.10
P2	2.00+/-0.05
W	8.00+0.30/-0.10
T	0.20+/-0.05

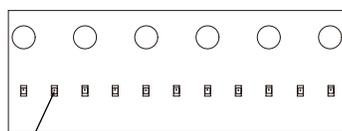

Pin 1 Location

Package Dimensions — 1004 DFN Array

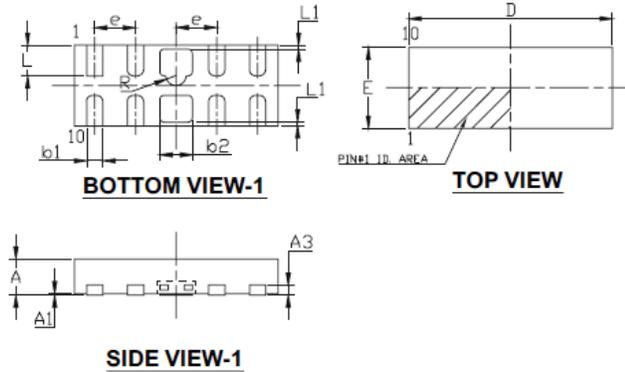

Symbol	Millimeters		Inches	
	Min	Max	Min	Max
A	0.40	0.60	0.013	0.024
A1	0.00	0.05	0.000	0.002
A3	0.127 REF		0.005 REF	
b1	0.15	0.25	0.006	0.010
b2	0.35	0.45	0.014	0.018
D	2.40	2.60	0.094	0.102
E	0.90	1.10	0.035	0.043
e	0.50 BSC		0.020 BSC	
L	0.28	0.48	0.011	0.019
L1	0.00	0.15	0.000	0.006
R	0.125 REF		0.005 REF	

SOLDERING PATTERN

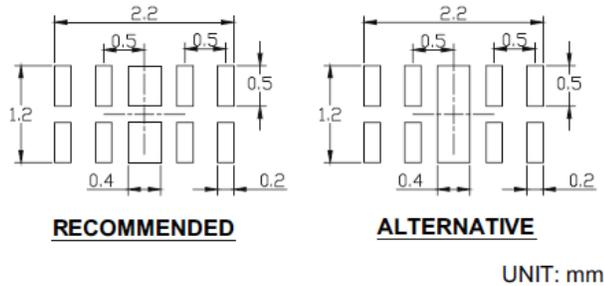

Embossed Carrier Tape & Reel Specification — 1004 DFN Array

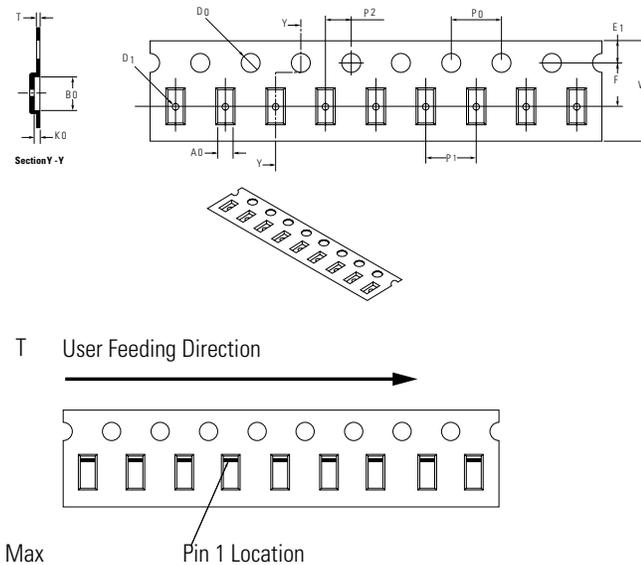

Symbol	Millimeters
A0	1.15 min/1.30 max
B0	2.70+/-0.05
D0	∅ 1.50 min/1.65 max
D1	∅ 0.50 min/1.05 max
E1	1.75+/-0.10
F	3.50+/-0.10
K0	0.46 min/0.75 max
P0	4.00+/-0.10
P1	4.00+/-0.10
P2	2.00+/-0.05
W	8.00+0.30/-0.10
T	0.17 min/0.30 max

X-ON Electronics

Largest Supplier of Electrical and Electronic Components

Click to view similar products for [ESD Suppressors / TVS Diodes](#) category:

Click to view products by [Littelfuse](#) manufacturer:

Other Similar products are found below :

[60KS200C](#) [D12V0H1U2WS-7](#) [D18V0L1B2LP-7B](#) [82356050220](#) [D5V0F4U5P5-7](#) [D5V0M5U6V-7](#) [NTE4902](#) [P4KE27CA](#) [P6KE11CA](#)
[P6KE39CA-TP](#) [P6KE8.2A](#) [SA110CA](#) [SA60CA](#) [SA64CA](#) [SMBJ12CATR](#) [SMBJ8.0A](#) [SMLJ30CA-TP](#) [ESD112-B1-02EL E6327](#)
[ESD119B1W01005E6327XTSA1](#) [ESD5V0J4-TP](#) [ESD5V0L1B02VH6327XTSA1](#) [ESD7451N2T5G](#) [19180-510](#) [CPDT-5V0USP-HF](#)
[3.0SMCJ33CA-F](#) [3.0SMCJ36A-F](#) [HSPC16701B02TP](#) [D3V3Q1B2DLP3-7](#) [D55V0M1B2WS-7](#) [DESD5V0U1BL-7B](#) [DRTR5V0U4SL-7](#)
[SCM1293A-04SO](#) [ESD203-B1-02EL E6327](#) [SM12-7](#) [SMF8.0A-TP](#) [SMLJ45CA-TP](#) [CEN955 W/DATA](#) [82350120560](#) [82356240030](#)
[VESD12A1A-HD1-GS08](#) [CPDUR5V0R-HF](#) [CPDUR24V-HF](#) [CPDQC5V0U-HF](#) [CPDQC5V0USP-HF](#) [CPDQC5V0-HF](#) [D1213A-01LP4-7B](#)
[D1213A-02WL-7](#) [ESDLIN1524BJ-HQ](#) [5KP100A](#) [5KP15A](#)