

SP3522

0.15pF 22kV ESD Protection diodes

HF **RoHS** **Pb** **GREEN** **ELV****Additional Information**

Resources

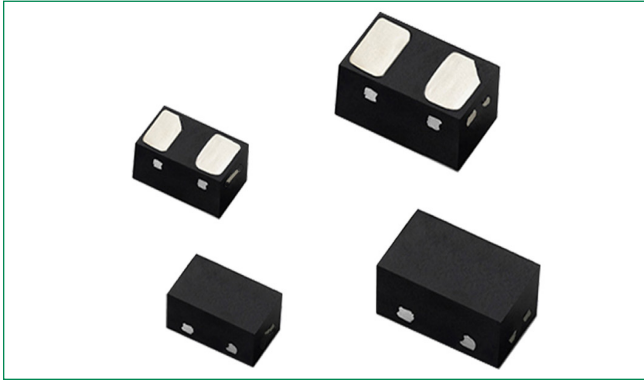

Accessories



Samples

Pinout

0201 DFN

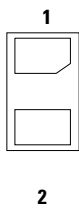

2

SOD882

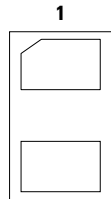

2

Bottom View

Description

The SP3522 integrates ultra low capacitance diodes to provide protection for electronic equipment that may experience destructive electrostatic discharges (ESD). This robust component can safely absorb repetitive ESD strikes above the maximum level specified in the IEC 61000-4-2 international standard ($\pm 8\text{kV}$ contact discharge) without performance degradation. The extremely low loading capacitance also makes it ideal for protecting high speed signal pins such as V-By-One®, HDMI, USB3.0, USB2.0, and IEEE 1394.

Features & Benefits

- ESD, IEC 61000-4-2, $\pm 22\text{kV}$ contact, $\pm 22\text{kV}$ air
- EFT, IEC 61000-4-4, 40A ($t_P=5/50\text{ns}$)
- Lightning, IEC 61000-4-5, 2nd edition, 2.5A ($t_P=8/20\mu\text{s}$)
- Low capacitance of 0.15pF (TYP) at 3GHz
- Low profile 0201 DFN packages and SOD882 packages
- Facilitates excellent signal integrity
- ELV Compliant
- AEC-Q101 Qualified
- Halogen free, Lead free and RoHS compliant
- Moisture Sensitivity Level(MSL -1)

Applications

- Ultra-high speed data lines
- USB 3.1, 3.0, 2.0
- HDMI 2.0, 1.4a, 1.3
- DisplayPort(TM)
- V-by-One®
- LVDS interfaces
- Consumer, mobile and portable electronics
- Tablet PC and external storage with high speed interfaces
- Applications requiring high ESD performance in small packages

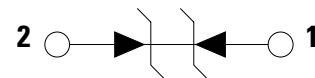
Functional Block Diagram**Absolute Maximum Ratings**

Symbol	Parameter	Value	Units
I_{PP}	Peak Current ($t_p=8/20\mu\text{s}$)	2.5	A
T_{OP}	Operating Temperature	-45 to 125	$^{\circ}\text{C}$
T_{STOR}	Storage Temperature	-55 to 150	$^{\circ}\text{C}$

Caution: Stresses above those listed in "Absolute Maximum Ratings" may cause permanent damage to the component. This is a stress only rating and operation of the component at these or any other conditions above those indicated in the operational sections of this specification is not implied.

SP3522

0.15pF 22kV ESD Protection diodes

Electrical Characteristics - (TOP=25°C)

Parameter	Test Conditions	Min	Typ	Max	Units
Input Capacitance	@ $V_R = 0V$, $f = 3GHz$		0.15		pF
Breakdown Voltage	V_{BR} @ $I_T=1mA$		9.2		V
Reverse Working Voltage	$I_R \leq 1\mu A$			7.0	V
Reverse Leakage Current	I_L @ $V_{RWM}=5.0V$		0.02	1	μA
Dynamic Resistance ²	TLP, $t_p=100ns$, I/O to GND		0.96		Ω
Clamping Voltage ¹	V_{CL} @ $I_{PP}=2.5A$		14.5		V
ESD Withstand Voltage ¹	IEC 61000-4-2 (Contact)	± 22			kV
	IEC 61000-4-2 (Air)	± 22			

Note:

- Parameter is guaranteed by design and/or component characterization.
- Transmission Line Pulse (TLP) with 100ns width, 2ns rise time, and average window $t_1=70ns$ to $t_2=90ns$

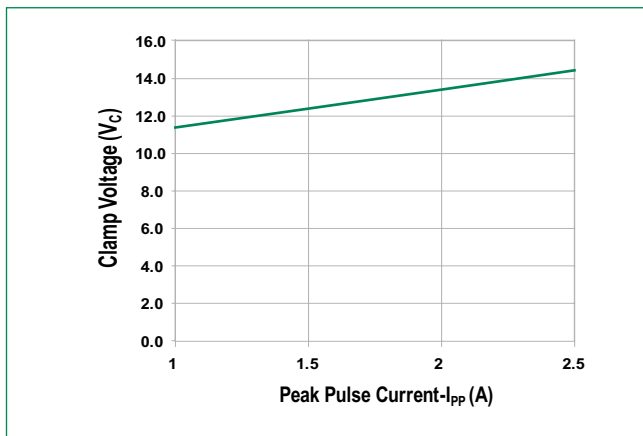
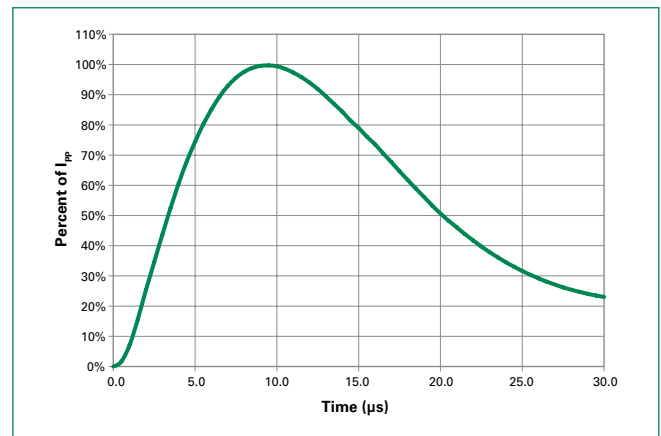
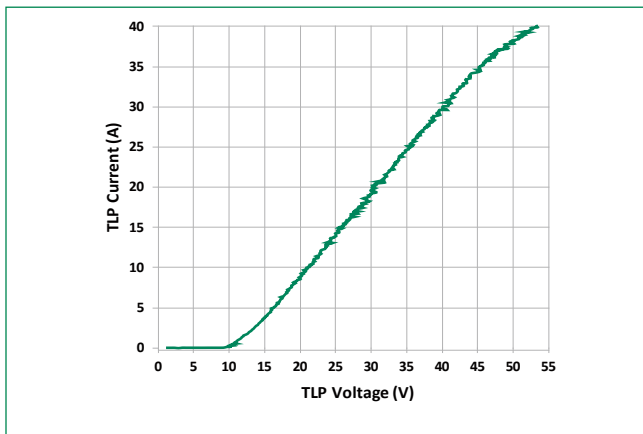
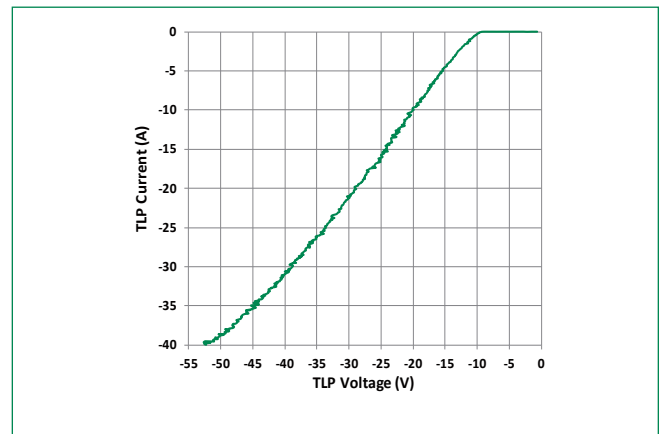
Clamping Voltage vs IPP**8/20 μ s Pulse Waveform****Positive Transmission Line Pulsing (TLP) Plot****Negative Transmission Line Pulsing (TLP) Plot**

SP3522

0.15pF 22kV ESD Protection diodes

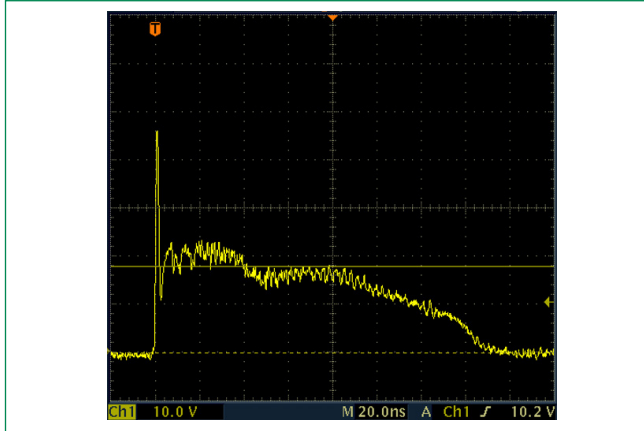
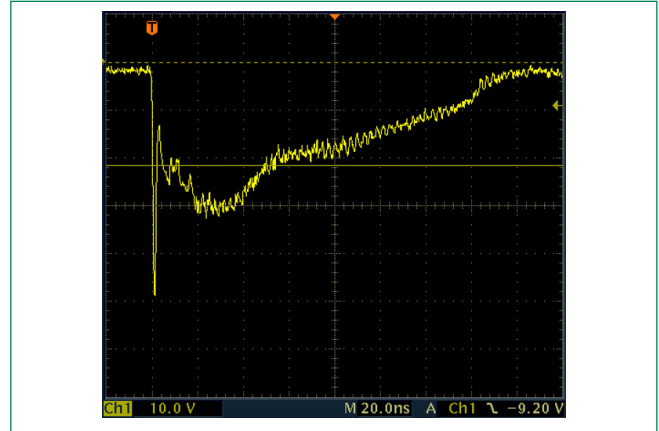
IEC 61000-4-2 +8 kV Contact ESD Clamping Voltage**IEC 61000-4-2 -8 kV Contact ESD Clamping Voltage****Soldering Parameters**

Reflow Condition		Pb – Free assembly
Pre Heat	- Temperature Min ($T_{s(min)}$)	150°C
	- Temperature Max ($T_{s(max)}$)	200°C
	- Time (min to max) (t_p)	60 – 180 secs
Average ramp up rate (Liquidus) Temp (T_L) to peak		3°C/second max
$T_{s(max)}$ to T_L - Ramp-up Rate		3°C/second max
Reflow	- Temperature (T_L) (Liquidus)	217°C
	- Temperature (t_L)	60 – 150 seconds
Peak Temperature (T_p)		260 ^{+0/-5} °C
Time within 5°C of actual peak Temperature (t_p)		20 – 40 seconds
Ramp-down Rate		6°C/second max
Time 25°C to peak Temperature (T_p)		8 minutes Max.
Do not exceed		260°C

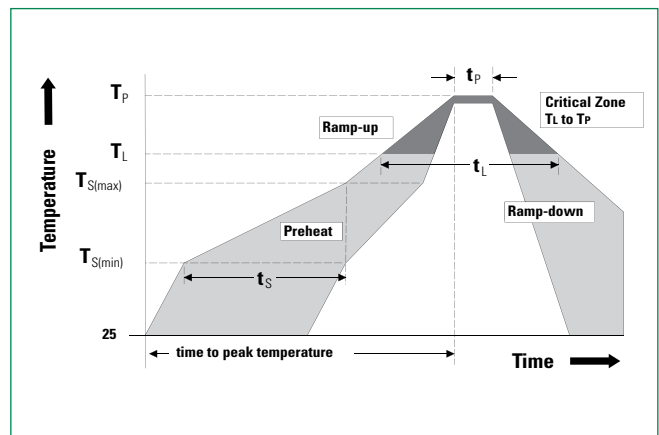
**Product Characteristics of 0201 DFN**

Lead Plating	Pre-Plated Frame
Lead Material	Copper Alloy
Substitute Material	Silicon
Body Material	Molded Compound
Flammability	UL Recognized compound meeting flammability rating V-0

Product Characteristics of SOD882

Lead Plating	Tin or Pre-Plated Frame
Lead Material	Copper Alloy
Substitute Material	Silicon
Body Material	Molded Compound
Flammability	UL Recognized compound meeting flammability rating V-0

SP3522

0.15pF 22kV ESD Protection diodes

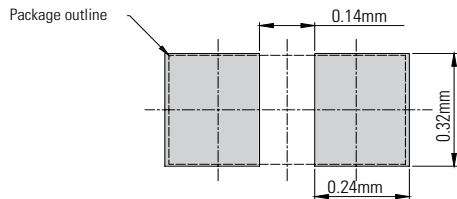
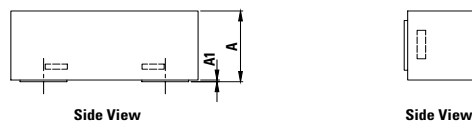
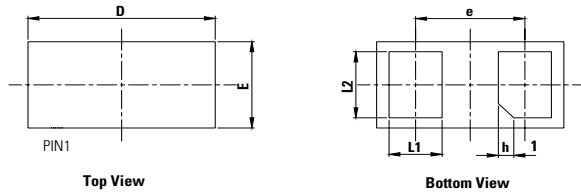
Package Dimensions — 0201 DFN

Recommended soldering pad layout

Symbol	Millimeters			Inches		
	Min	Typ.	Max	Min	Typ.	Max
A	0.23	0.28	0.33	0.009	0.011	0.013
A1	0.00	0.02	0.05	0.000	0.001	0.002
L1	0.12	0.18	0.24	0.005	0.007	0.009
L2	0.18	0.24	0.30	0.007	0.009	0.012
D	0.55	0.60	0.65	0.022	0.024	0.026
E	0.25	0.30	0.35	0.010	0.012	0.014
e	0.35 (BSC)			0.014 (BSC)		
h	0.05 (x 45°)			0.002 (x 45°)		

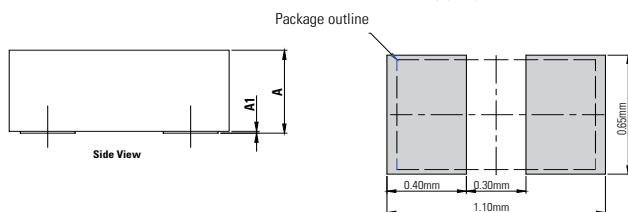
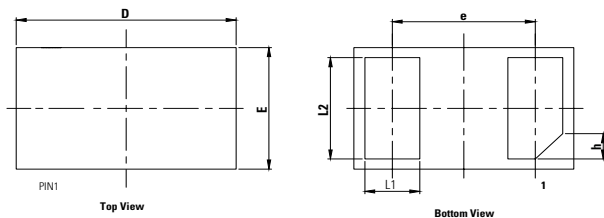
Package Dimensions — SOD882

Recommended soldering pad layout

Symbol	Millimeters			Inches		
	Min	Typ.	Max	Min	Typ.	Max
A	0.40	0.45	0.50	0.016	0.018	0.020
A1	0.00	0.02	0.05	0.000	0.001	0.002
L1	0.20	0.25	0.30	0.008	0.010	0.012
L2	0.45	0.50	0.55	0.018	0.020	0.022
D	0.90	1.00	1.10	0.035	0.039	0.043
E	0.50	0.60	0.70	0.020	0.024	0.028
e	0.65 (BSC)			0.026 (BSC)		
h	0.125 (x 45°)			0.005 (x 45°)		

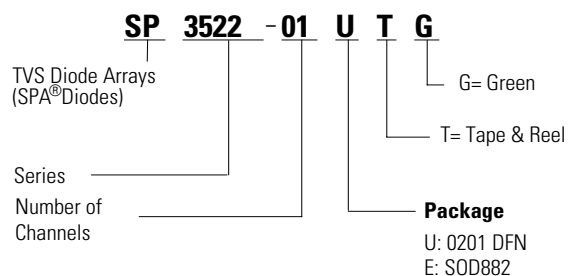
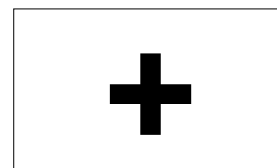
Part Numbering System**Part Marking System****Ordering Information**

Part Number	Package	Min. Order Qty.
SP3522-01UTG	0201 DFN	15000
SP3522-01ETG	SOD882	10000

SP3522

0.15pF 22kV ESD Protection diodes

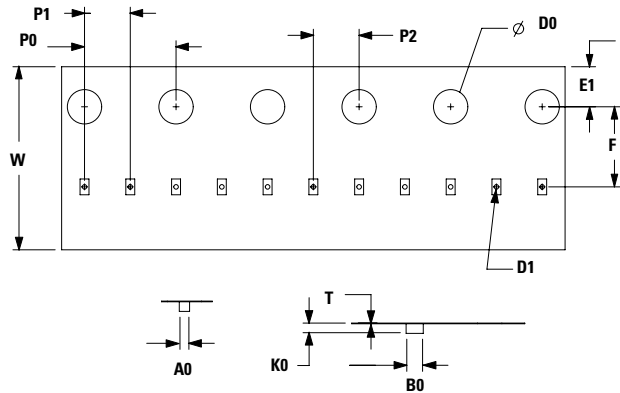
Embossed Carrier Tape & Reel Specification — 0201 DFN

Symbol	Millimeters
A0	0.33 min/0.41 max
B0	0.63 min/0.71 max
D0	$\varnothing 1.50 +0.10/-0$
D1	$\varnothing 0.20 \pm 0.05$
E1	1.75 \pm 0.10
F	3.50 \pm 0.05
K0	0.30 min/0.39 max
P0	4.00 \pm 0.10
P1	2.00 \pm 0.10
P2	2.00 \pm 0.05
W	8.00 \pm 0.30/-0.10
T	0.13 min/0.25 max

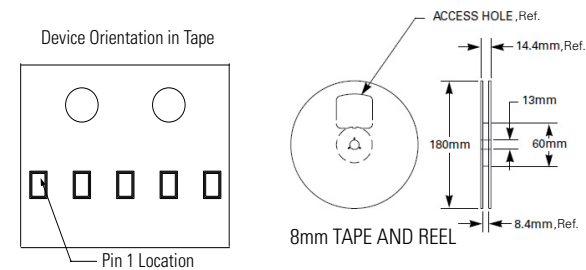
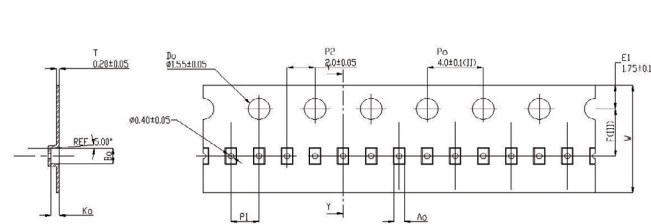
**Embossed Carrier Tape & Reel Specification — SOD882**

Symbol	Millimeters
A0	0.70 \pm 0.045
B0	1.10 \pm 0.045
K0	0.65 \pm 0.045
F	3.50 \pm 0.05
P1	2.00 \pm 0.10
W	8.00 + 0.30 -0.10

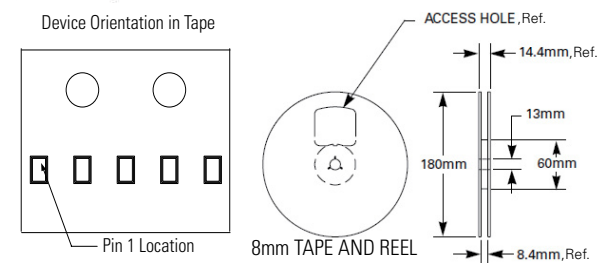

Disclaimer Notice - Information furnished is believed to be accurate and reliable. However, users should independently evaluate the suitability of and test each product selected for their own applications. Littelfuse products are not designed for, and may not be used in, all applications. Read complete Disclaimer Notice at <http://www.littelfuse.com/disclaimer-electronics>.

X-ON Electronics

Largest Supplier of Electrical and Electronic Components

Click to view similar products for [ESD Suppressors / TVS Diodes](#) category:

Click to view products by [Littelfuse](#) manufacturer:

Other Similar products are found below :

[60KS200C](#) [D12V0H1U2WS-7](#) [D18V0L1B2LP-7B](#) [82356050220](#) [D5V0M5U6V-7](#) [NTE4902](#) [P4KE27CA](#) [P6KE11CA](#) [P6KE39CA-TP](#)
[P6KE8.2A](#) [SA110CA](#) [SA60CA](#) [SA64CA](#) [SMBJ12CATR](#) [SMBJ8.0A](#) [SMLJ30CA-TP](#) [ESD112-B1-02EL](#) [E6327](#)
[ESD119B1W01005E6327XTSA1](#) [ESD5V0J4-TP](#) [ESD5V0L1B02VH6327XTSA1](#) [ESD7451N2T5G](#) [19180-510](#) [CPDT-5V0USP-HF](#)
[3.0SMCJ33CA-F](#) [3.0SMCJ36A-F](#) [HSPC16701B02TP](#) [D3V3Q1B2DLP3-7](#) [D55V0M1B2WS-7](#) [DESD5V0U1BL-7B](#) [DRTR5V0U4SL-7](#)
[SCM1293A-04SO](#) [ESD203-B1-02EL](#) [E6327](#) [SM12-7](#) [SMF8.0A-TP](#) [SMLJ45CA-TP](#) [CEN955 W/DATA](#) [82350120560](#) [82356240030](#)
[VESD12A1A-HD1-GS08](#) [CPDUR5V0R-HF](#) [CPDUR24V-HF](#) [CPDQC5V0U-HF](#) [CPDQC5V0USP-HF](#) [CPDQC5V0-HF](#) [D1213A-01LP4-7B](#)
[D1213A-02WL-7](#) [ESDLIN1524BJ-HQ](#) [5KP100A](#) [5KP15A](#) [5KP18A](#)