

Solid State Relays

SRP1-CB

High-Endurance Solid-State Relay



Description

The SRP1-CB High-Endurance series of multipurpose solid-state relays (SSRs) ensures superior uptime. Designed for high-frequency operation, the Littelfuse SRP1-CB series provides consistent and reliable performance for applications that demand extensive on/off switching.

The relays broad voltage range and Zero Cross & Instantaneous switching make them compatible across a wide selection of single-phase and high-power three-phase applications from industrial machinery to commercial use.

Using the latest manufacturing techniques in Direct Bonding Technology and featuring high-end power semiconductors (Littelfuse proprietary IXYS Technology) this relay guarantees maximum quality, reliability, and longevity even under tough conditions compared to any other relay in the market.

Features & Benefits

FEATURES	BENEFITS
High-Endurance Design	Provides enhanced operational reliability and up to 2x-3x times more life endurance cycles, ensuring consistent performance even in demanding conditions
Compliance with International Standards (cULus, CE)	Ensures the Solid-State Relay (SSR) has undergone rigorous testing, providing enhanced safety and product quality
Broad Application Spectrum	Engineered to accommodate a diverse range of applications and load types, offering flexibility and utility in various engineering projects

Applications

- Cooking ovens & hot drinks dispensers
- Theatrical, public & traffic lighting control
- Air handlers and other HVAC equipment
- Plastic & packaging machinery
- Industrial ovens & electronics production equipment
- Heating and motion control in industrial automation

Solid State Relays

SRP1-CB

Ordering Information

FOR HEATING & LIGHTING CONTROL						
CATALOG #	OUTPUT MAX CURRENT	OUTPUT VOLTAGE	OUTPUT SWITCHING STYLE	OUTPUT OVERVOLTAGE PROTECTION	INPUT VOLTAGE RANGE	COMPLIANCE
SRP1-CBDZL-010NW-N	10 A	24-240 V AC	Zero Cross	-	4-32 V DC	cRUus, CE
SRP1-CBAZL-010NW-N	10 A	24-240 V AC	Zero Cross	-	90-280 V AC	cRUus, CE
SRP1-CBDZL-025NW-N	25 A	24-240 V AC	Zero Cross	-	4-32 V DC	cRUus, CE
SRP1-CBAZL-025NW-N	25 A	24-240 V AC	Zero Cross	-	90-280 V AC	cRUus, CE
SRP1-CBDZH-025NW-N	25 A	48-600 V AC	Zero Cross	-	4-32 V DC	cRUus, CE
SRP1-CBAZH-025NW-N	25 A	48-600 V AC	Zero Cross	-	90-280 V AC	cRUus, CE
SRP1-CBDZL-050NW-N	50 A	24-240 V AC	Zero Cross	-	4-32 V DC	cRUus, CE
SRP1-CBAZL-050NW-N	50 A	24-240 V AC	Zero Cross	-	90-280 V AC	cRUus, CE
SRP1-CBDZH-050NW-N	50 A	48-600 V AC	Zero Cross	-	4-32 V DC	cRUus, CE
SRP1-CBAZH-050NW-N	50 A	48-600 V AC	Zero Cross	-	90-280 V AC	cRUus, CE

FOR OTHER LOADS CONTROL						
CATALOG #	OUTPUT MAX CURRENT	OUTPUT NOMINAL VOLTAGE	OUTPUT SWITCHING STYLE	OUTPUT OVERVOLTAGE PROTECTION	INPUT VOLTAGE RANGE	COMPLIANCE
SRP1-CBDRL-010NW-N	10 A	24-240 V AC	Instantaneous ³	-	4-32 V DC	cRUus, CE
SRP1-CBARL-010NW-N	10 A	24-240 V AC	Instantaneous ³	-	90-280 V AC	cRUus, CE
SRP1-CBDRL-025NW-N	25 A	24-240 V AC	Instantaneous ³	-	4-32 V DC	cRUus, CE
SRP1-CBARL-025NW-N	25 A	24-240 V AC	Instantaneous ³	-	90-280 V AC	cRUus, CE
SRP1-CBDRH-025NW-N	25 A	48-600 V AC	Instantaneous ³	-	4-32 V DC	cRUus, CE
SRP1-CBARH-025NW-N	25 A	48-600 V AC	Instantaneous ³	-	90-280 V AC	cRUus, CE
SRP1-CBDRL-050NW-N	50 A	24-240 V AC	Instantaneous ³	-	4-32 V DC	cRUus, CE
SRP1-CBARL-050NW-N	50 A	24-240 V AC	Instantaneous ³	-	90-280 V AC	cRUus, CE
SRP1-CBDRH-050NW-N	50 A	48-600 V AC	Instantaneous ³	-	4-32 V DC	cRUus, CE
SRP1-CBARH-050NW-N	50 A	48-600 V AC	Instantaneous ³	-	90-280 V AC	cRUus, CE

Input/Control Specifications¹

GENERAL DATA						
SYMBOL	PARAMETER	RANGE	VALUE FOR DC INPUT VERSIONS	UNIT	VALUE FOR AC INPUT VERSIONS	UNIT
Uc	Input (Control) Voltage*	Maximum	32	V DC	280	V AC
		Nominal	5 – 12 – 24	V DC	120 - 240	V AC
		Minimum	4	V DC	90	V AC
Urv	Reverse Voltage	Maximum	-32	V DC	N/A	V AC
Uc on	Turn-On Voltage (Pick-up/Engage/Activation Voltage)	Minimum	4.0	V DC	90	V AC
Uc off	Turn-Off Voltage (Drop Out/Release/Deactivation Voltage)	Nominal	1.0	V DC	10	V AC
Ic	Input (Control) Current	Maximum	12	mA	7	mA
		Minimum	7	mA	4	mA
-	Input Impedance	Nominal	Current Regulated	-	Current Regulated	-
-	Turn-On Time	Maximum	½ (20 us for instant on)	Cycle	20 (using nominal input voltage range)	ms
-	Turn-Off Time	Maximum	½	Cycle	30	ms

*Limit Input voltage to 240 V AC above 40 °C Surrounding Ambient for AC Versions.

Solid State Relays

SRP1-CB

Output/Load Specifications¹

GENERAL DATA							
SYMBOL	PARAMETER	CONDITION	RANGE	VALUE FOR 10A VERSIONS	VALUE FOR 25A VERSIONS	VALUE FOR 50A VERSIONS	UNIT
-	Output Configuration	-	-	SPST-NO	SPST-NO	SPST-NO	-
f	Operating Frequency	-	Minimum	47	47	47	Hz
			Nominal	50 – 60	50 – 60	50 – 60	
			Maximum	63	63	63	
Ue	Operating Voltage	For Low-Voltage Versions	Minimum	24	24	24	Vrms
			Nominal	120 - 240	120 - 240	120 - 240	
			Maximum	280	280	280	
Ue	Operating Voltage	For High-Voltage Versions	Minimum	48	48	48	Vrms
			Nominal	400-600	400-600	400-600	
			Maximum	660	660	660	
V	On-State Voltage Drop	At Rated Current	Maximum	1.15 V	1.15 V	1.3 V	Vrms
Vto	Threshold Voltage (Power Loss Calculations only)	Tvj = 150 °C	Maximum	0.88	0.88	0.88	V
rt	On state dynamic resistance (Power Loss Calculations only)	Tvj = 150 °C	Maximum	6.3	6.3	6.3	mΩ
Up	Transient Over-Voltage (Peak/Blocking/Non-Repetitive Voltage)	-	Maximum	1200	1200	1200	Vpk
Itsm	Transient Over-Current (Surge/Overload/Non-Repetitive Current)	1/2 Cycle At 50/60 Hz (Tvj=45 °C)	Maximum	220/260	420/460	620/660	Apk
Ilk	Leakage Current (Off-State)	At Rated Voltage	Maximum	1	1	1	mArms
dv/dt	Critical dV/dt (Off-State)	At Maximum Rated Voltage	Minimum	500	500	500	V/μsec
I ² t	I ² t Value for Fusing	½ Cycle at 50/60Hz (Tvj=45 °C)	Minimum	800/900	1200/1300	1800/1900	A ² sec
Pf	Minimum Power Factor	At Maximum Load	Minimum	0.5	0.5	0.5	-
-	Thermal Resistance Junction to Case (Rjc)			1.0	0.8	0.5	°C/W

Littelfuse SSRs are versatile and can handle different types of loads, such as light, motors, and others. However, the maximum continuous current value given in this datasheet is only for resistive loads (specifically AC-1 type), which are mainly used for heating control.

SYMBOL	PARAMETER	CONDITION	RANGE	VALUE FOR 10A VERSIONS	VALUE FOR 25A VERSIONS	VALUE FOR 50A VERSIONS	UNIT
Ie (AC-51)	Load Current (Continuous) – Heating Elements (AC-1)	At 40 °C	Maximum	10	25	50	Arms
			Minimum	0.15	0.15	0.15	Arms

Solid State Relays

SRP1-CB

Thermal Derating Curves (for heatsink selection)

To operate the Solid-State Relay (SSR) at its specified ratings, the use of a heatsink is mandatory. The following thermal derating curves illustrate the maximum load current that our SSRs can manage under varying ambient temperatures and heatsink sizes. It is crucial to select a heatsink that is most suitable for your specific application.

10A VERSIONS:

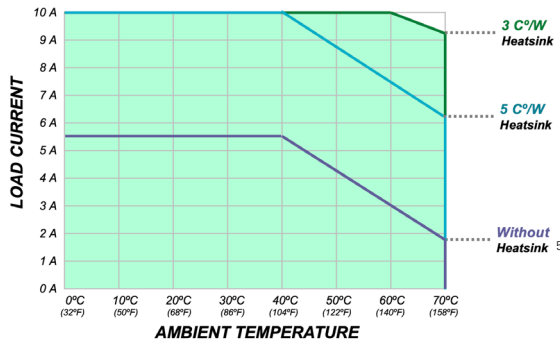

25A VERSIONS:

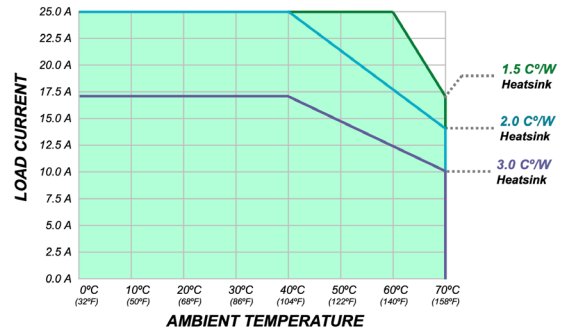

50A VERSIONS:

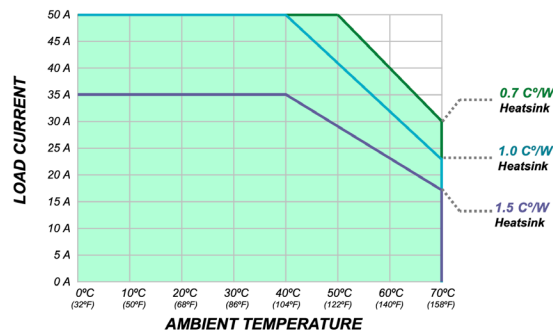

Considerations - Switching Type

In applications requiring precise temperature management, solid-state relays (SSRs) play a crucial role. Specifically, the Zero Cross Switching type of SSR is commonly employed to regulate heaters based on signals from a temperature controller. This technology proves particularly valuable in scenarios where high-frequency switching occurs—such as when a heater cycles on and off frequently over short intervals for extended periods.

Considerations - Inrush Current

It's essential to recognize that variations exist between different types of heating elements, especially in hot or cold conditions. While it is generally expected that heating elements exhibit no inrush current, in certain heating elements cold conditions can lead to an inrush current equivalent to 1.4 times the nominal current. To mitigate this, we highly recommend oversizing the current rating and ensuring an appropriately sized heatsink. Doing so improves the relay's thermal endurance and extends its operational lifespan.

So, when selecting an SSR, consider using one with a capacity approximately 1.4 times that of the heater or operating the SSR at only 75%-80% of its maximum capacity. The following table provides guidance for choosing the right SSR for a specific heater load.

NOMINAL SSR CURRENT RATING	MAXIMUM RECOMMENDED HEATER CURRENT	HEATER POWER AT 120 VAC	HEATER POWER AT 240 VAC	HEATER POWER AT 400 VAC	HEATER POWER AT 480 VAC	HEATER POWER AT 600 VAC
10 A	8 A	960 W	1.9 KW	3.2 KW	3.8 KW	4.8 KW
25 A	20 A	2.4 KW	4.8 KW	8.0 KW	9.6 KW	12.0 KW
50 A	40 A	4.8 KW	9.6 KW	16.0 KW	19.2 KW	24.0 KW

Solid State Relays

SRP1-CB

General Specifications¹

GENERAL DATA					
SYMBOL	PARAMETER	CONDITION	RANGE	VALUE	UNIT
-	LED for Input (Control) Status Indicator	-	-	Continuously ON Green LED, when control input is applied	-
Ui	Isolation (Dielectric Strength) Input/Output/Base	50/60 HZ	Nominal	4 000	Vrms
Ri	Insulation Resistance	@ 500 V DC	Minimum	1	GΩ
-	Coupling Capacitance	-	Maximum	8	pF
-	Endurance* according to American Standard UL508	-	Typical	100,000	Cycles

*The SRP1 series is engineered for durability, having undergone rigorous testing to ensure a minimum lifespan of 100,000 Endurance cycles, with each cycle consisting of a 1-second activation followed by a 9-second rest, at twice the rated current. This means that the relay can be expected to operate reliably for 100,000 times under these conditions, but it may have a shorter or longer lifetime depending on other factors, such as switching frequency, environmental temperature, and humidity.

ENVIRONMENTAL DATA					
SYMBOL	PARAMETER	CONDITION	RANGE	VALUE	UNIT
-	Vibration (Test conducted in accordance with the Vibration Environmental Testing Guidelines of the International Standard <i>IEC 60068-2-6</i>)	5-100Hz	Nominal	10	g
-	Shock (Test conducted in accordance with the Shock Environmental Testing Guidelines of the International Standard <i>IEC 60068-2-27</i>)	11ms	Nominal	50	g
-	Ambient Temperature - Operating (Working) ⁶	No icing, no condensation	Maximum	70 (158)	°C (°F)
-	Ambient Temperature - Storage	No icing, no condensation	Minimum	-40 (-40)	°C (°F)
-	Relative Ambient Humidity (Per international standard <i>IEC/EN 60068-2-78</i>)	Non-condensing @ 40 °C	Maximum	100 (212)	°C (°F)
HR	Pollution Degree	Non-conductive pollution with condensation possibilities	Minimum	-40 (-40)	°C (°F)
-			Nominal	93	%
-			Nominal	2	

MECHANICAL DATA					
SYMBOL	PARAMETER	CONDITION	RANGE	VALUE	UNIT
-	Product Weight	-	Typical	100 (0.22)	g (lbs)
-	Housing Material (In accordance with the American Standard UL-94 for Safety of Flammability of Plastic Materials for Parts in Devices and Appliances)	-	-	Plastic UL 94 V-0	-
-	Baseplate Material	-	-	Aluminum	-
-	Touch Protection Level (Test conducted in accordance with the IP Code of Degrees of Protection Testing Guidelines of the International Standard <i>IEC 60529</i>)	-	-	IP00	-
-	Screw Torque Range	Input Terminals	Typical	1.5-1.7 (13-15)	Nm (in-lb)
-		Output Terminals	Typical	2-2.2 (18-20)	Nm (in-lb)
-		SSR Mounting	Typical	2-2.2 (18-20)	Nm (in-lb)
-	Screw Thread Size	Input Terminals	-	M4 x 0.7	-
-		Output Terminals	-	M5 x 0.8	-
-		SSR Mounting	-	M4 x 0.7 or #8-32 Pan Head	-

Solid State Relays

SRP1-CB

Product Dimensions

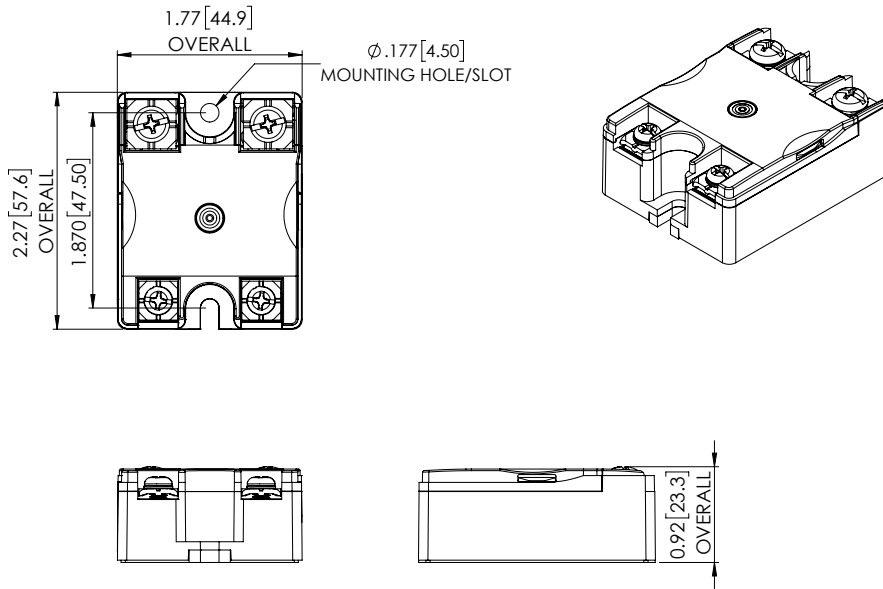

Wiring Diagrams

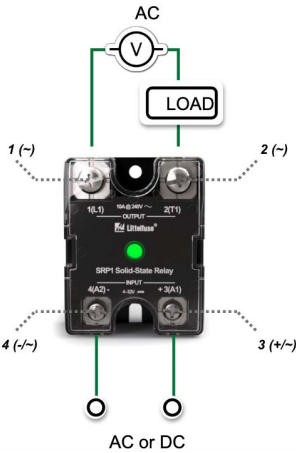

Equivalent Circuit Block Diagrams

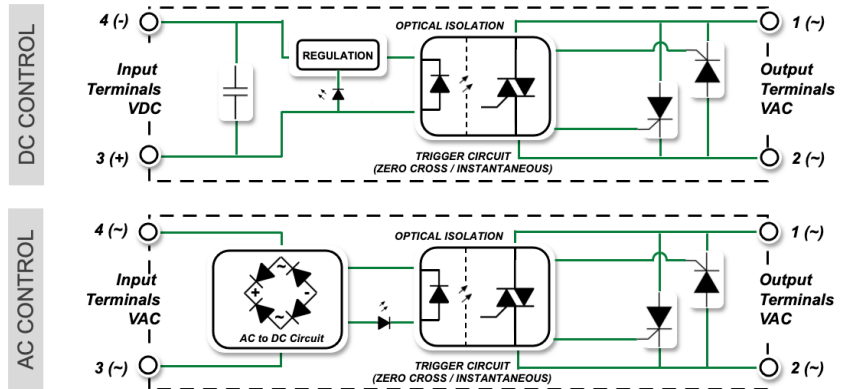

Short-Circuit Protection by Fuse

To safeguard solid-state relays (SSRs) against load short circuits, the use of fuses is essential, especially fast-acting ones. Here are the key considerations:



- **Fuse Selection:** The I²t value (energy withstand capability) of the fuse should be less than half of the I²t value of the relay. Standard fuses are inadequate because they cannot react swiftly enough to prevent fault currents from exceeding the maximum levels that thyristors (used in SSRs) can handle. Therefore, we strongly recommend employing ultra-fast fuses.
- **Fuse Placement:** Position the fuse in front of the SSR in the circuit. This strategic placement ensures that if the relay must unexpectedly break the earth insulation (due to overheating, case damage, or leakage with the heatsink), the fuse will protect the entire circuit from firing.
- **Resource for Fuse Options:** For the most suitable fuse options, consider checking the [Littelfuse website](https://www.littelfuse.com).







Solid State Relays

SRP1-CB

Standards Conformity & Certifications



Product Safety Certifications

Products tested, compliant and certified to the following standards that states the requirements for electrical products to ensure they are safe for consumers to use.







CERTIFICATION BODY MARK	CERTIFICATION BODY NAME	CERTIFICATION DESCRIPTION	STANDARDS COVERED BY THE CERTIFICATION
 No. E183688	cRUus	North American certificate of compliance with the Safety requirements for Industrial Control Equipment	 UL508 American Standard of Safety for Industrial Control Equipment.  CAN/CSA C22.2 No.14-18 Canadian Standard of Safety for Industrial Control Equipment.
	CE	Conformity with the European safety, health, and environmental protection requirements.	 LVD Directive 2014/35/EU EU Directive of Safety for Low Voltage Gear Equipment. In accordance with the Low Voltage Gear Testing Guidelines of the International Standard IEC 60947-4-3  EMC Directive 2014/30/EU EU Directive of Electromagnetic Compatibility. In accordance with the Low Voltage Gear Testing Guidelines of the International Standard IEC 60947-4-3  RoHS Directive 2015/863/EU EU Directive of Hazardous Substances Restriction. In accordance with the Assessment of electrical and electronic products with respect to the restriction of Hazardous substances Guidelines of the International Standard IEC 63000

EMC Compliance (Electro-magnetic compatibility)

Radiated Emissions

-	STANDARD NAME	STANDARD DESCRIPTION	STANDARD NUMBER	LEVELS
	Radiated RF	Radio interference field emission (radiated)	International Standard CISPR 11	Class B: 30M – 1GHz
	Conducted RF	Radio interference voltage emissions (conducted)	International Standard CISPR 11	Class B (with external filter): 150k – 30MHz

Immunity



-	STANDARD NAME	STANDARD DESCRIPTION	STANDARD NUMBER	LEVELS
	ESD	Immunity to Electrostatic Discharge (ESD)	International Standard IEC 61000-4-2	Level 3 -Contact Discharge: 6 kV -Air Discharge: 8 kV
	Radiated RF	Immunity to Radiated Radio Frequency	International Standard IEC 61000-4-3	-Level 3: 10 V/m (80MHz-2GHz) -Level 2: 3 V/m (2GHz-6GHz)
	Burst	Immunity Electrical Fast Transients (Burst)	International Standard IEC 61000-4-4	Level 3: 2 kV
	Surge	Immunity to Electrical Surges	International Standard IEC 61000-4-5	Level 3: -Line to line: 1 kV -Line to ground: 2 kV
	Conducted RF	Immunity to Conducted Radio Frequency	International Standard IEC 61000-4-6	Level 3: 10V/m (0.15 - 80 MHz)
	Dips	Immunity to Voltage Dips	International Standard IEC 61000-4-11	-0% for 0.5, 1 cycle, Performance Criteria A -40% for 10/12 cycles, Performance Criteria A -70% for 25/30 cycles, Performance Criteria A -80% for 250/300 cycles, Performance Criteria A
	Interruptions	Immunity to Voltage Interruptions	International Standard IEC 61000-4-11	0% for 250/300 cycles, Performance Criteria B

Solid State Relays

SRP1-CB

Environmental Compliance⁴

Products comply to the following environmental standard requirements for electrical products to ensure they are safe for consumers to use.

-	STANDARD NAME	STANDARD DESCRIPTION	STANDARD NUMBER
	RoHS	Conformity with the European Restriction of Hazardous Substances in electrical and electronic products	European Directive 2015/863/EU (IEC 63000)
	REACH	Conformity with the Registration, Evaluation, Authorization and Restriction of Chemicals regulation to ensure safe use of chemicals	European Directive 1907/2006

Notes:

1. All parameters at 25 °C unless otherwise specified.
2. CE declared up to 480 V.
3. Instantaneous turn-on version is not recommended for incandescent lamp (Tungsten) and capacitive loads. Use zero turn-on only.
4. The environmental compliance data reflects the most current information available and adheres to our rigorous standards for quality and sustainability. These specifications are valid from the product's initial release and are subject to change with ongoing improvements.
5. If no heatsink is used then the baseplate has to be exposed to free ambient air.
6. AC input option minimum operating temperature is -20 (-4).

Warning Information

Caution: Material Damage, Electric Shock, and Arc Flash Hazard. Before installing or working with this product, take the following precautions:

1. **Disconnect all power:** Ensure that all power sources are disconnected.
2. **Verify connections:** Double-check all connections.

Failure to adhere to these instructions may lead to **serious injury or damage** of equipment.

Disclaimer Notice – Information furnished is believed to be accurate and reliable. However, users should independently evaluate the suitability of and test each product selected for their own applications. Littelfuse products are not designed for, and may not be used in, all applications. Read complete Disclaimer Notice at www.littelfuse.com/product-disclaimer.

X-ON Electronics

Largest Supplier of Electrical and Electronic Components

Click to view similar products for [Solid State Relays - Industrial Mount](#) category:

Click to view products by [Littelfuse](#) manufacturer:

Other Similar products are found below :

[D2440-C](#) [H10CA4890](#) [H10CD4890](#) [D4840B](#) [D4875C](#) [1395831-1](#) [SE-K4EN](#) [A-1326](#) [H10CA4850](#) [H12CA4890VL](#) [RA2410-D06](#)
[RA2410HA06T](#) [TD1205](#) [D53TP50-10](#) [W230E-1-12](#) [W230T-3-12](#) [1-1617030-3](#) [MS2-D2420](#) [MS2-D2430](#) [A-1440](#) [G3TAOD201SDC24](#) [1-](#)
[1617033-0](#) [SMT8628521](#) [ESUC0480](#) [SRH3-1440R](#) [XKA70420](#) [G3PH-5150BAC100-240](#) [GN325DSZH](#) [GN350ASZH](#) [GN325ASZH](#)
[GN350DSZH](#) [1109564](#) [G3NB-205B-1](#) [DC5-24](#) [GNRD06CDL](#) [GN325DSRH](#) [GNR25DCZH](#) [52511](#) [CWH-62-WO](#) [E-1048-8I4-C3D4V1-](#)
[4U3-10A](#) [E-1048-8I4-C3D1V0-4U3-5A](#) [RGC1P60CM25KEN](#) [48ATE3S00X204](#) [48BTG3S00X204](#) [E3P2G48D75](#) [RA4025H10PCS](#)
[RKD2A60D50P](#) [RK2A60D50P](#) [RK2A60D75P](#) [PVG612](#) [CPC1008N](#)