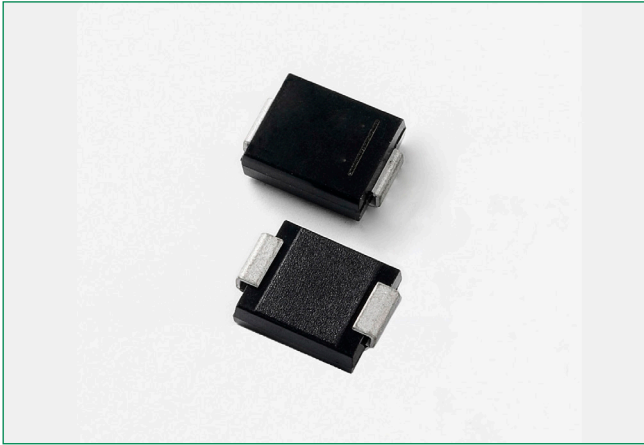



## SZ1.5SMC Series



### Agency Approvals

| Agency  | Agency File Number |
|---|--------------------|
|  | E128662            |

### Maximum Ratings and Thermal Characteristics

| Parameter  | Symbol          | Value       | Unit                       |
|--|-----------------|-------------|----------------------------|
| Peak Power Dissipation (Note 1) @ $T_L = 25^\circ\text{C}$ , Pulse Width = 1 ms          | $P_{PK}$        | 1500        | W                          |
| DC Power Dissipation @ $T_L = 75^\circ\text{C}$  | $P_D$           | 4.0         | W                          |
| Measured Zero Lead Length (Note 2)   | $R_{\theta JL}$ | 54.6        | $\text{mW}/^\circ\text{C}$ |
| Derate Above $75^\circ\text{C}$  | $R_{\theta JA}$ | 18.3        | $^\circ\text{C}/\text{W}$  |
| Thermal Resistance from Junction-to-Lead   |                 |             |                            |
| DC Power Dissipation (Note 3) @ $T_A = 25^\circ\text{C}$ Derate Above $25^\circ\text{C}$ | $P_D$           | 0.75        | W                          |
| Thermal Resistance from Junction-to-Ambient  | $R_{\theta JA}$ | 6.1         | $\text{mW}/^\circ\text{C}$ |
|  |                 | 165         | $^\circ\text{C}/\text{W}$  |
| Forward Surge Current (Note 4) @ $T_A = 25^\circ\text{C}$                                | $I_{FSM}$       | 200         | A                          |
| Operating and Storage Temperature Range  | $T_J, T_{stg}$  | -65 to +150 | $^\circ\text{C}$           |

Stresses exceeding Maximum Ratings may damage the device. Maximum Ratings are stress ratings only. Functional operation above the Recommended Operating Conditions is not implied. Extended exposure to stresses above the Recommended Operating Conditions may affect device reliability.

- 10 x 1000  $\mu\text{s}$ , non-repetitive.
- 1 in square copper pad, FR-4 board.
- FR-4 board, using Littelfuse minimum recommended footprint, as shown in 403-03 case outline dimensions spec.
- 1/2 sine wave (or equivalent square wave),  $P_W = 8.3$  ms, duty cycle = 4 pulses per minute maximum.

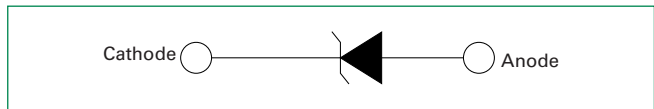
### Description

The SZ1.5SMC series is designed to protect voltage sensitive components from high voltage, high energy transients. They have excellent clamping capability, high surge capability, low zener impedance and fast response time. The SZ1.5SMC series is supplied in the exclusive, cost-effective, highly reliable Littelfuse package and is ideally suited for use in communication systems, automotive, numerical controls, process controls, medical equipment, business machines, power supplies and many other industrial/consumer applications.

### Features

- Zener Transient Overvoltage Suppressors
- Working Peak Reverse Voltage Range – 5.8 V to 77.8 V
- Standard Zener Breakdown Voltage Range – 6.45 V to 95.5V
- Peak Power – 1500 W @ 1 ms
- ESD Rating of Class 3 (> 16 KV) per Human Body Model
- Maximum Clamp Voltage @ Peak Pulse Current
- Low Leakage < 5  $\mu\text{A}$  Above 10 V
- Recognized to UL 497B as an Isolated Loop Circuit Protector
- Maximum Temperature Coefficient Specified
- Response Time is Typically < 1 ns
- Pb-Free Packages are Available
- SZ Prefix for Automotive and Other Applications Requiring Unique Site and Control Change Requirements; AEC-Q101 Qualified and PPAP Capable

### Functional Diagram



### Additional Information



Datasheet

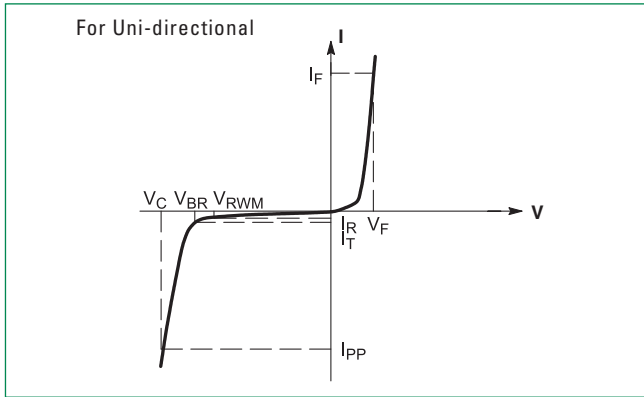


Resources



Samples

**I-V Curve Characteristics** ( $T_A = 25^\circ\text{C}$  unless otherwise noted,  $V_F = 3.5\text{ V Max @ } I_F = 100\text{ A}$ ) (Note 5)



| Symbol    | Parameter                                   |
|-----------|---|
| $I_{PP}$  | Maximum Reverse Peak Pulse Current          |
| $V_C$     | Clamping Voltage @ $I_{PP}$                 |
| $V_{RWM}$ | Working Peak Reverse Voltage                |
| $I_R$     | Maximum Reverse Leakage Current @ $V_{RWM}$ |
| $V_{BR}$  | Breakdown Voltage @ $I_T$                   |
| $I_T$     | Test Current                                |
| $I_F$     | Forward Current                             |
| $V_F$     | Forward Voltage @ $I_F$                     |

5. 1/2 sine wave (or equivalent square wave),  $PW = 8.3\text{ ms}$ , non-repetitive duty cycle.

**Electrical Characteristics** ( $T_A = 25^\circ\text{C}$  unless otherwise noted)

| Device          | Device Marking | $V_{RWM}$ (Note 6) | $I_R @ V_{RWM}$ | Breakdown Voltage     |               |      |         | $V_C @ I_{PP}$ (Note 8) |          | MV BR TYP. |
|-----------------|----------------|--------------------|-----------------|-----------------------|---------------|------|---------|-------------------------|----------|------------|
|                 |                |                    |                 | $V_{BR}$ (V) (Note 7) |               |      | @ $I_T$ | $V_C$                   | $I_{PP}$ |            |
|                 |                |                    |                 | Volts                 | $\mu\text{A}$ | Min  | Nom     | Max                     | mA       | Volts      |
| SZ1.5SMC6.8AT3G | 6V8A           | 5.8                | 1000            | 6.45                  | 6.8           | 7.14 | 10      | 10.5                    | 143      | 0.057      |
| SZ1.5SMC7.5AT3G | 7V5A           | 6.4                | 500             | 7.13                  | 7.5           | 7.88 | 10      | 11.3                    | 132      | 0.061      |
| SZ1.5SMC10AT3G  | 10A            | 8.55               | 10              | 9.5                   | 10            | 10.5 | 1       | 14.5                    | 103      | 0.073      |
| SZ1.5SMC12AT3G  | 12A            | 10.2               | 5               | 11.4                  | 12            | 12.6 | 1       | 16.7                    | 90       | 0.078      |
| SZ1.5SMC13AT3G  | 13A            | 11.1               | 5               | 12.4                  | 13            | 13.7 | 1       | 18.2                    | 82       | 0.081      |
| SZ1.5SMC15AT3G  | 15A            | 12.8               | 5               | 14.3                  | 15            | 15.8 | 1       | 21.2                    | 71       | 0.084      |
| SZ1.5SMC16AT3G  | 16A            | 13.6               | 5               | 15.2                  | 16            | 16.8 | 1       | 22.5                    | 67       | 0.086      |
| SZ1.5SMC18AT3G  | 18A            | 15.3               | 5               | 17.1                  | 18            | 18.9 | 1       | 25.2                    | 59.5     | 0.088      |
| SZ1.5SMC20AT3G  | 20A            | 17.1               | 5               | 19                    | 20            | 21   | 1       | 27.7                    | 54       | 0.09       |
| SZ1.5SMC22AT3G  | 22A            | 18.8               | 5               | 20.9                  | 22            | 23.1 | 1       | 30.6                    | 49       | 0.092      |
| SZ1.5SMC24AT3G  | 24A            | 20.5               | 5               | 22.8                  | 24            | 25.2 | 1       | 33.2                    | 45       | 0.094      |
| SZ1.5SMC27AT3G  | 27A            | 23.1               | 5               | 25.7                  | 27            | 28.4 | 1       | 37.5                    | 40       | 0.096      |
| SZ1.5SMC30AT3G  | 30A            | 25.6               | 5               | 28.5                  | 30            | 31.5 | 1       | 41.4                    | 36       | 0.097      |
| SZ1.5SMC33AT3G  | 33A            | 28.2               | 5               | 31.4                  | 33            | 34.7 | 1       | 45.7                    | 33       | 0.098      |
| SZ1.5SMC36AT3G  | 36A            | 30.8               | 5               | 34.2                  | 36            | 37.8 | 1       | 49.9                    | 30       | 0.099      |
| SZ1.5SMC39AT3G  | 39A            | 33.3               | 5               | 37.1                  | 39            | 41   | 1       | 53.9                    | 28       | 0.1        |
| SZ1.5SMC43AT3G  | 43A            | 36.8               | 5               | 40.9                  | 43            | 45.2 | 1       | 59.3                    | 25.3     | 0.101      |
| SZ1.5SMC47AT3G  | 47A            | 40.2               | 5               | 44.7                  | 47            | 49.4 | 1       | 64.8                    | 23.2     | 0.101      |
| SZ1.5SMC51AT3G  | 51A            | 43.6               | 5               | 48.5                  | 51            | 53.6 | 1       | 70.1                    | 21.4     | 0.102      |
| SZ1.5SMC56AT3G  | 56A            | 47.8               | 5               | 53.2                  | 56            | 58.8 | 1       | 77                      | 19.5     | 0.103      |
| SZ1.5SMC62AT3G  | 62A            | 53                 | 5               | 58.9                  | 62            | 65.1 | 1       | 85                      | 17.7     | 0.104      |
| SZ1.5SMC68AT3G  | 68A            | 58.1               | 5               | 64.6                  | 68            | 71.4 | 1       | 92                      | 16.3     | 0.104      |
| SZ1.5SMC75AT3G  | 75A            | 64.1               | 5               | 71.3                  | 75            | 78.8 | 1       | 103                     | 14.6     | 0.105      |
| SZ1.5SMC82AT3G  | 82A            | 70.1               | 5               | 77.9                  | 82            | 86.1 | 1       | 113                     | 13.3     | 0.105      |
| SZ1.5SMC91AT3G  | 91A            | 77.8               | 5               | 86.5                  | 91            | 95.5 | 1       | 125                     | 12       | 0.106      |

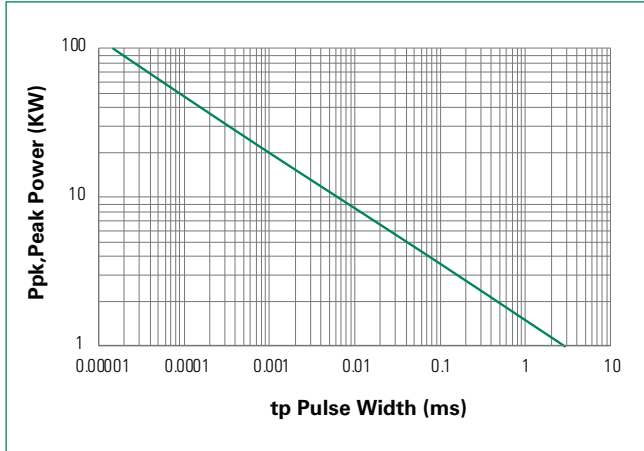
6. A transient suppressor is normally selected according to the maximum working peak reverse voltage ( $V_{RWM}$ ), which should be equal to or greater than the DC or continuous peak operating voltage level.

7.  $V_{BR}$  measured at pulse test current  $I_T$  at an ambient temperature of  $25^\circ\text{C}$ .

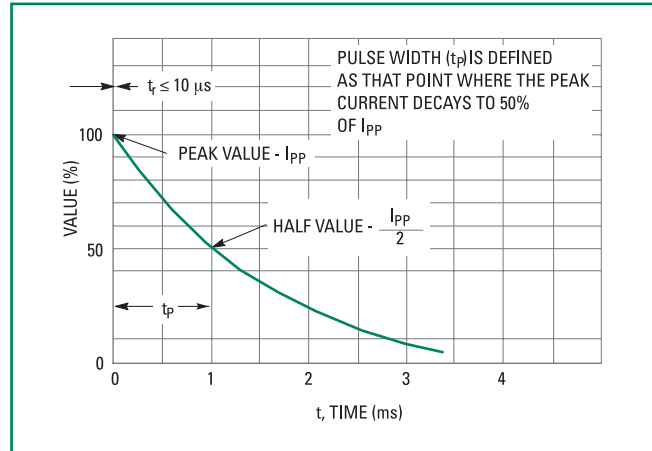
8. Surge current waveform per Figure 2 and derate per Figure 3 of the General Data – 1500 Watt at the beginning of this group.

**Ratings and Characteristic Curves**

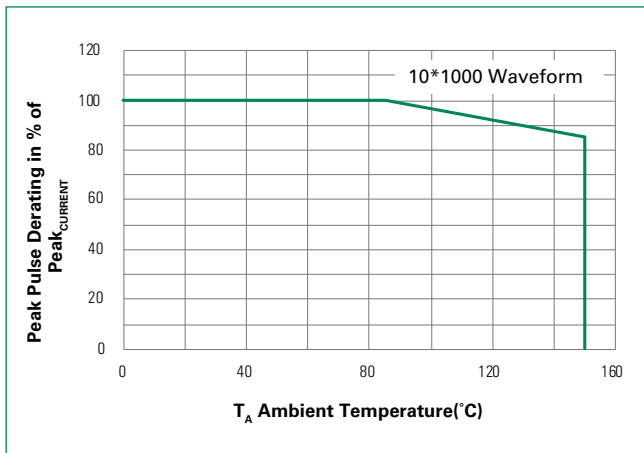
**Figure 1. Pulse Rating Curve**



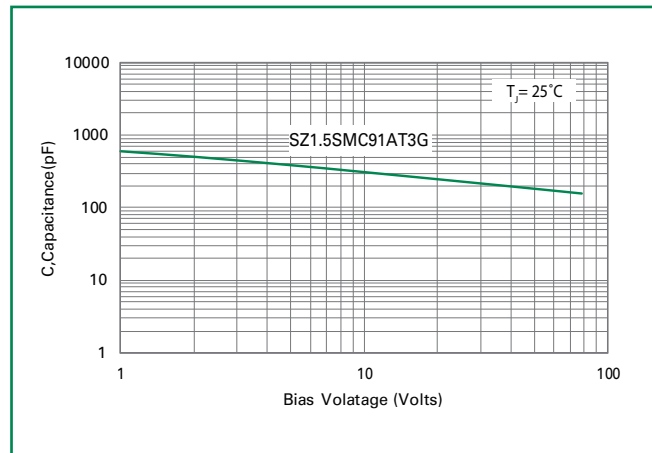
**Figure 2. Pulse Waveform**



**Figure 3. Surge Derating Curve**

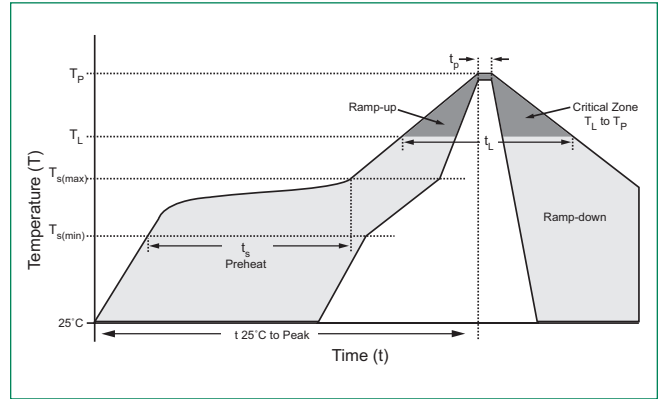


**Figure 4. Typical Junction Capacitance vs. Bias Voltage**



### Soldering Parameters

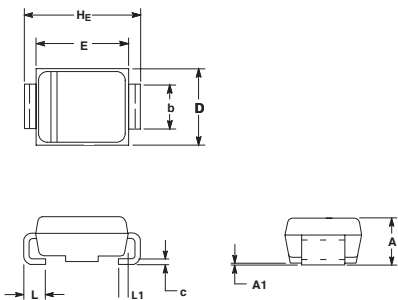
|  |                                    |                         |
|--|------------------------------------|-------------------------|
| <b>Reflow Condition</b>  |                                    | Lead-free assembly      |
| <b>Pre Heat</b>  | - Temperature Min ( $T_{s(min)}$ ) | 150°C                   |
|  | - Temperature Max ( $T_{s(max)}$ ) | 200°C                   |
|  | - Time (min to max) ( $t_p$ )      | 60 – 120 secs           |
| <b>Average ramp up rate (Liquidus Temp (<math>T_L</math>) to peak)</b> |                                    | 3°C/second max          |
| <b><math>T_{s(max)}</math> to <math>T_L</math> - Ramp-up Rate</b>      |                                    | 3°C/second max          |
| <b>Reflow</b>  | - Temperature ( $T_L$ ) (Liquidus) | 217°C                   |
|  | - Time (min to max) ( $t_L$ )      | 60 – 150 seconds        |
| <b>Peak Temperature (<math>T_p</math>)</b>                             |                                    | 260 <sup>+0/-5</sup> °C |
| <b>Time within 5°C of actual peak Temperature (<math>t_p</math>)</b>   |                                    | 30 seconds max          |
| <b>Ramp-down Rate</b>  |                                    | 6°C/second max          |
| <b>Time 25°C to peak Temperature (<math>T_p</math>)</b>                |                                    | 8 minutes max.          |
| <b>Do not exceed</b>   |                                    | 260°C                   |



### Physical Specifications

|                 |   |
|-----------------|---|
| <b>Weight</b>   | 0.00733 ounce, 0.228 grams  |
| <b>Case</b>     | JEDEC DO214AB. Void-Free, Transfer-Molded, Thermosetting Plastic Epoxy Meets UL 94V-0 |
| <b>Polarity</b> | Color band denotes cathode for unidirectional components.                             |
| <b>Terminal</b> | Matte Tin-plated leads, Solderable per JESD22-B102                                    |

### Dimensions

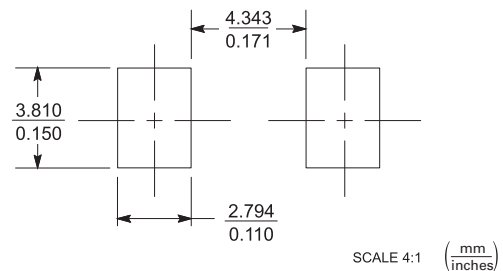


| Dim | Inches    |       |       | Millimeters |      |      |
|-----|-----------|-------|-------|-------------|------|------|
|     | Min       | Nom   | Max   | Min         | Nom  | Max  |
| A   | 0.079     | 0.087 | 0.095 | 2.00        | 2.22 | 2.41 |
| A1  | 0.002     | 0.004 | 0.008 | 0.05        | 0.10 | 0.20 |
| b   | 0.115     | 0.118 | 0.125 | 2.92        | 3.00 | 3.18 |
| c   | 0.006     | 0.009 | 0.012 | 0.15        | 0.23 | 0.30 |
| D   | 0.220     | 0.230 | 0.240 | 5.59        | 5.84 | 6.10 |
| E   | 0.260     | 0.270 | 0.280 | 6.60        | 6.86 | 7.11 |
| HE  | 0.305     | 0.313 | 0.320 | 7.75        | 7.94 | 8.13 |
| L   | 0.030     | 0.040 | 0.050 | 0.76        | 1.02 | 1.27 |
| L1  | 0.020 REF |       |       | 0.051 REF   |      |      |

### Environmental Specifications

|                            |                          |
|----------------------------|--------------------------|
| <b>High Temp. Storage</b>  | JESD22-A103              |
| <b>HTRB</b>                | JESD22-A108              |
| <b>Temperature Cycling</b> | JESD22-A104              |
| <b>MSL</b>                 | JEDEC-J-STD-020, Level 1 |
| <b>H3TRB</b>               | JESD22-A101              |
| <b>RSH</b>                 | JESD22-A111              |

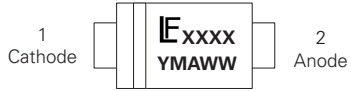
### Soldering Footprint



### Ordering Information

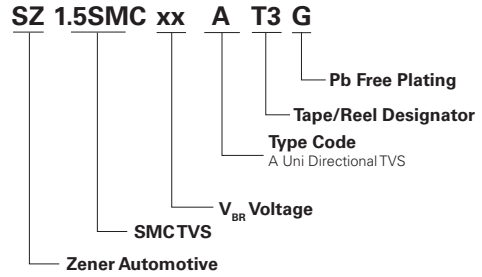
| Device         | Package       | Shipping            |
|----------------|---------------|---------------------|
| SZ1.5SMCxxAT3G | SMC (Pb-Free) | 2,500 / Tape & Reel |

**Part Marking System**

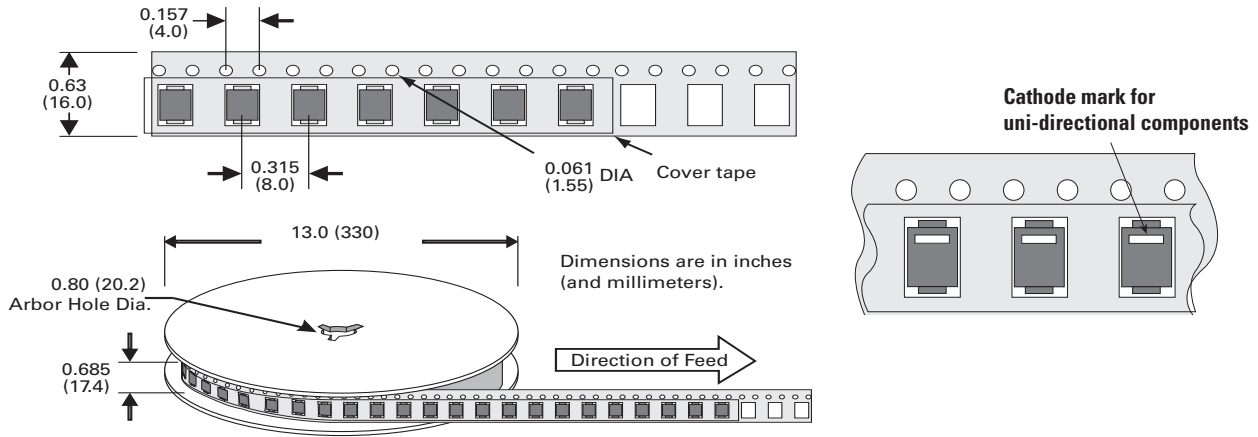


XXXX = Device Code (max four digits)  
 Y = Year  
 M = Month  
 A = Assembly Location  
 WW = Lot Code

**Part Numbering System**



**Tape and Reel Specification**



**Disclaimer Notice** - Information furnished is believed to be accurate and reliable. However, users should independently evaluate the suitability of and test each product selected for their own applications. Littelfuse products are not designed for, and may not be used in, all applications. Read complete Disclaimer Notice at: [www.littelfuse.com/disclaimer-electronics](http://www.littelfuse.com/disclaimer-electronics).

## X-ON Electronics

Largest Supplier of Electrical and Electronic Components

*Click to view similar products for [Littelfuse](#) manufacturer:*

Other Similar products are found below :

[SMAJ7.5C](#) [SMAJ7.0C](#) [SMAJ60](#) [LT60100FBC](#) [LT60200-1C](#) [0215015.MRET1P](#) [0235.500MXP](#) [02393.15HXP](#) [02400107P](#) [740GN](#) [900-166H-031GN](#) [RA30391121](#) [127.002](#) [DUR60120W](#) [1.5KE110A-B](#) [1.5KE220CA-B](#) [1.5KE540CA](#) [BBS1A05A10](#) [BBS1A12A10](#) [P6KE27CA](#) [224001P](#) [235.200](#) [KLDR07.5TXP](#) [L70S250.V](#) [SMBJ350A](#) [LSP10347P](#) [FLSR200](#) [21701.6-P](#) [224007](#) [CCMR050.T](#) [2410SFV3.00FM/125-2](#) [257030](#) [281005](#) [GTCA28-312L-R03](#) [H-34](#) [Q201E3RP](#) [313.25](#) [LT60200FBC](#) [353001](#) [35413150029](#) [357006](#) [362001](#) [37012000430](#) [MAHC0001TXJ](#) [333.750](#) [3455LS1](#) [345903A](#) [36915000000](#) [37000500410](#) [37211600411](#)