

## SZ1SMA5.0AT3G Series

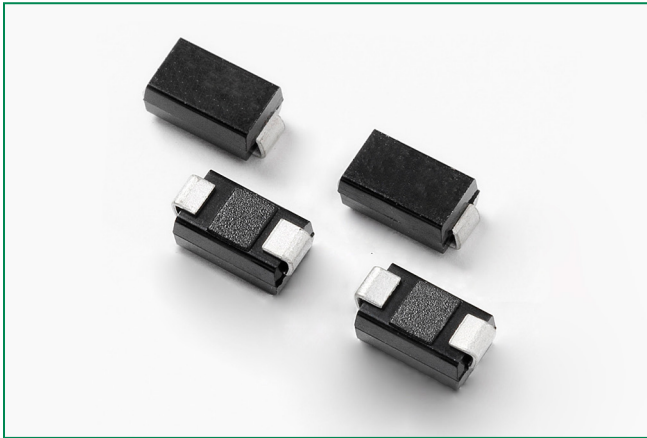

### Maximum Ratings and Thermal Characteristics

Parameter	Symbol	Value	Unit
Peak Power Dissipation (Note 1) @ $T_L = 25^\circ\text{C}$ , Pulse Width = 1 ms	$P_{PK}$	400	W
DC Power Dissipation @ $T_L = 75^\circ\text{C}$ Measured Zero Lead Length (Note 2) Derate Above $75^\circ\text{C}$	$P_D$	1.0 20	W mW/°C
Thermal Resistance from Junction to-Lead	R <sub>JL</sub>	50	°C/W
DC Power Dissipation (Note 3) @ $T_A = 25^\circ\text{C}$ Derate Above $25^\circ\text{C}$	$P_D$	0.5 4.0	W mW/°C
Thermal Resistance from Junction-to-Ambient	R <sub>0JA</sub>	250	°C/W
Forward Surge Current (Note 4) @ $T_A = 25^\circ\text{C}$	$I_{FSM}$	40	A
Operating and Storage Temperature Range	$T_J, T_{stg}$	-65 to +150	°C

Stresses exceeding those listed in the Maximum Ratings table may damage the device. If any of these limits are exceeded, device functionality should not be assumed, damage may occur and reliability may be affected.

- 10 X 1000  $\mu\text{s}$ , non-repetitive.
- 1" square copper pad, FR-4 board.
- FR-4 board, using Littelfuse minimum recommended footprint, as shown in 403D-02 case outline dimensions spec.
- 1/2 sine wave (or equivalent square wave), PW = 8.3 ms, duty cycle = 4 pulses per minute maximum.

### Description

The SZ1SMA5.0AT3G series is designed to protect voltage sensitive components from high voltage, high energy transients. They have excellent clamping capability, high surge capability, low zener impedance and fast response time. The SZ1SMA5.0AT3G series is supplied in the Littelfuse exclusive, cost-effective, highly reliable package and is ideally suited for use in communication systems, automotive, numerical controls, process controls, medical equipment, business machines, power supplies and many other industrial/consumer applications.

### Features

- Working Peak Reverse Voltage Range – 5.0 V to 78 V
- Standard Zener Breakdown Voltage Range – 6.7 V to 91.25 V
- Peak Power – 400 W @ 1 ms
- ESD Rating of Class 3 (> 16 kV) per Human Body Model
- Response Time is Typically < 1 ns
- Flat Handling Surface for Accurate Placement
- Package Design for Top Slide or Bottom Circuit Board Mounting
- Low Profile Package
- These are Pb-Free Device

### Functional Diagram

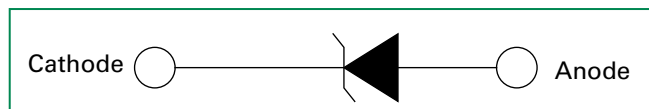

### Additional Information



Datasheet



Resources



Samples

**I-V Curve Characteristics** ( $T_A = 25^\circ\text{C}$  unless otherwise noted,  $V_f = 3.5\text{ V Max.}$  @  $I_f = 30\text{ A}$  for all types) (Note 5)

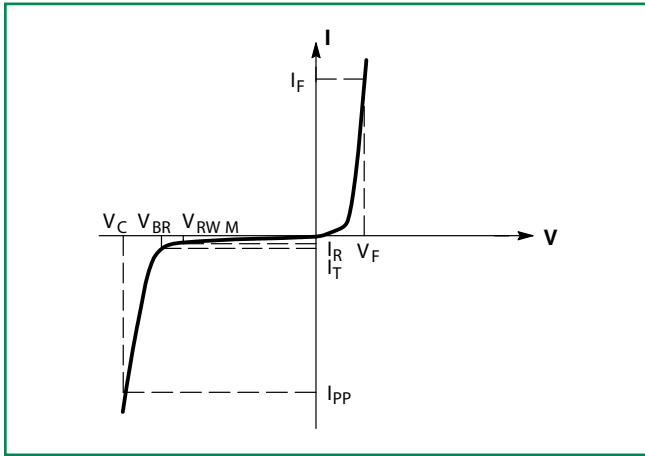

Symbol	Parameter
$I_{PP}$	Maximum Reverse Peak Pulse Current
$V_C$	Clamping Voltage @ $I_{PP}$
$V_{RWM}$	Working Peak Reverse Voltage
$I_R$	Maximum Reverse Leakage Current @ $V_{RWM}$
$V_{BR}$	Breakdown Voltage @ $I_T$
$I_T$	Test Current
$I_F$	Maximum Temperature Coefficient of $V_{BR}$
$V_F$	Forward Voltage @ $I_F$
$VF$	Forward Voltage @ $I_F$

5. 1/2 sine wave or equivalent, PW = 8.3 ms, non-repetitive duty cycle.

### Electrical Characteristics

Device*	Device Marking	V <sub>RWM</sub> (Note 6)	I <sub>R</sub> @ V <sub>RWM</sub>	Breakdown Voltage				V <sub>C</sub> @ I <sub>PP</sub> (Note 8)		C Typ. (Note 9)
				V <sub>BR</sub> @ I <sub>T</sub> (V) (Note 7)			@ I <sub>T</sub>	V <sub>C</sub>	I <sub>PP</sub>	
				MIN	NOM	MAX	mA	Volts	Amps	
SZ1SMA5.0AT3G	QE	5.0	400	6.4	6.7	7.0	10	9.2	43.5	2035
SZ1SMA6.0AT3G	QG	6.0	400	6.67	7.02	7.37	10	10.3	38.8	1730
SZ1SMA6.5AT3G	QK	6.5	250	7.22	7.6	7.98	10	11.2	35.7	1605
SZ1SMA8.0AT3G	QR	8.0	25	8.89	9.36	9.83	1	13.6	29.4	1035
SZ1SMA8.5AT3G	QT	8.5	5.0	9.44	9.92	10.4	1	14.4	27.8	1265
SZ1SMA9.0AT3G	QV	9.0	2.5	10	10.55	11.1	1	15.4	26.0	1200
SZ1SMA10AT3G	QX	10	2.5	11.1	11.7	12.3	1	17.0	23.5	1090
SZ1SMA11AT3G	QZ	11	2.5	12.2	12.85	13.5	1	18.2	22.0	1000
SZ1SMA12AT3G	RE	12	2.5	13.3	14.0	14.7	1	19.9	20.1	925
SZ1SMA13AT3G	RG	13	2.5	14.4	15.15	15.9	1	21.5	18.6	860
SZ1SMA14AT3G	RH	14	2.5	15.6	16.4	17.2	1	23.2	17.2	800
SZ1SMA15AT3G	RM	15	2.5	16.7	17.6	18.5	1	24.4	16.4	758
SZ1SMA16AT3G	RP	16	2.5	17.8	18.75	19.7	1	26.0	15.4	715
SZ1SMA17AT3G	RR	17	2.5	18.9	19.9	20.9	1	27.6	14.5	680
SZ1SMA18AT3G	RT	18	2.5	20	21.05	22.1	1	29.2	13.7	645
SZ1SMA20AT3G	RV	20	2.5	22.2	23.35	24.5	1	32.4	12.3	585
SZ1SMA22AT3G	RX	22	2.5	24.4	25.65	26.9	1	35.5	11.3	540
SZ1SMA24AT3G	RZ	24	2.5	26.7	28.1	29.5	1	38.9	10.3	500
SZ1SMA26AT3G	SE	26	2.5	28.9	30.4	31.9	1	42.1	9.5	460
SZ1SMA28AT3G	SG	28	2.5	31.1	32.75	34.4	1	45.4	8.8	430
SZ1SMA30AT3G	SK	30	2.5	33.3	35.05	36.8	1	48.4	8.3	405
SZ1SMA33AT3G	SM	33	2.5	36.7	38.65	40.6	1	53.3	7.5	375
SZ1SMA36AT3G	SP	36	2.5	40	42.1	44.2	1	58.1	6.9	345
SZ1SMA40AT3G	SR	40	2.5	44.4	46.75	49.1	1	64.5	6.2	315
SZ1SMA43AT3G	ST	43	2.5	47.8	50.3	52.8	1	69.4	5.8	295
SZ1SMA45AT3G	SV	45	2.5	50	52.65	55.3	1	72.2	5.5	280
SZ1SMA48AT3G	SX	48	2.5	53.3	56.1	58.9	1	77.4	5.2	265
SZ1SMA54AT3G	TE	54	2.5	60	63.15	66.3	1	87.1	4.6	240
SZ1SMA58AT3G	TG	58	2.5	64.4	67.8	71.5	1	93.6	4.3	225
SZ1SMA70AT3G	TP	70	2.5	77.8	81.9	86.0	1	113	3.5	190

6. A transient suppressor is normally selected according to the working peak reverse voltage (V<sub>RWM</sub>), which should be equal to or greater than the DC or continuous peak operating voltage level.

7. V<sub>BR</sub> measured at pulse test current I<sub>T</sub> at an ambient temperature of 25°C.

8. Surge current waveform per Figure 2 and derate per Figure 3.

9. Bias voltage = 0 V, F = 1.0 MHz, T<sub>J</sub> = 25°C.

†Please see 1SMA10CAT3 to 1SMA75CAT3 for Bidirectional devices.

**Ratings and Characteristic Curves**

**Figure 1. Pulse Rating Curve**

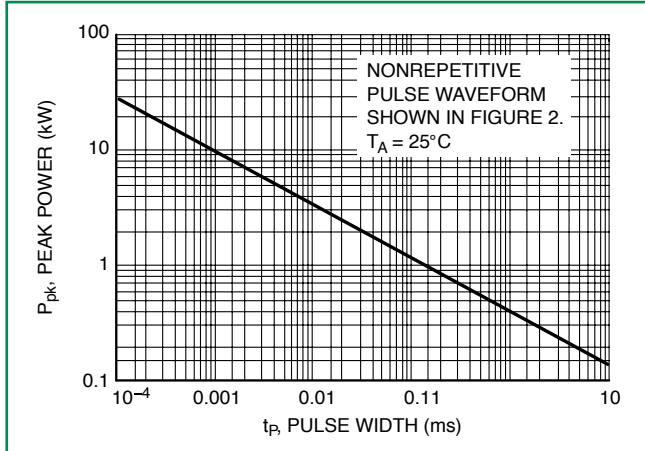

**Figure 2. Pulse Waveform**

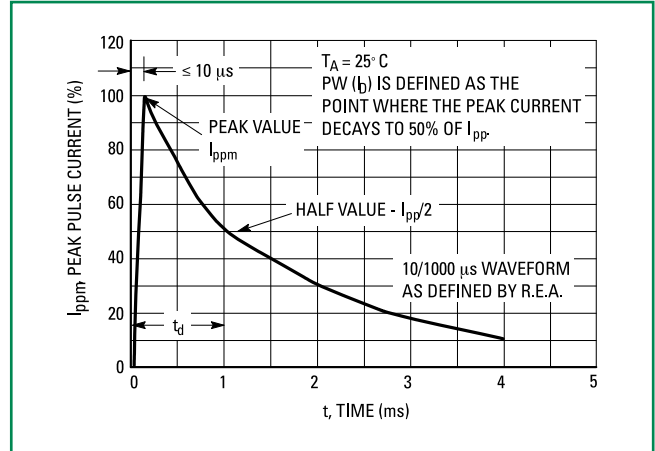

**Figure 3 - Pulse Derating Curve**

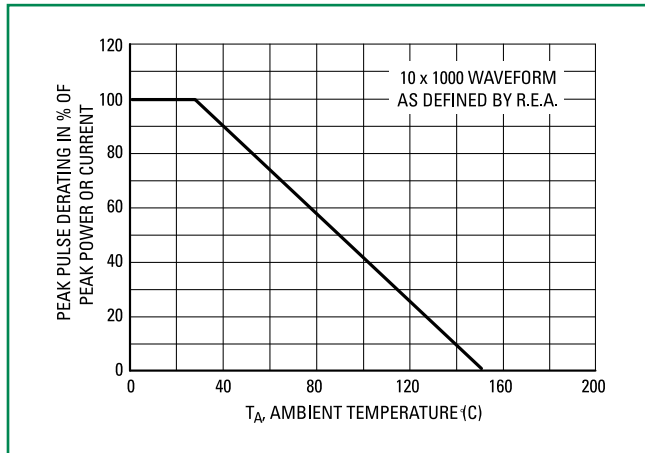

**Figure 4. Typical Junction Capacitance vs. Bias Voltage**

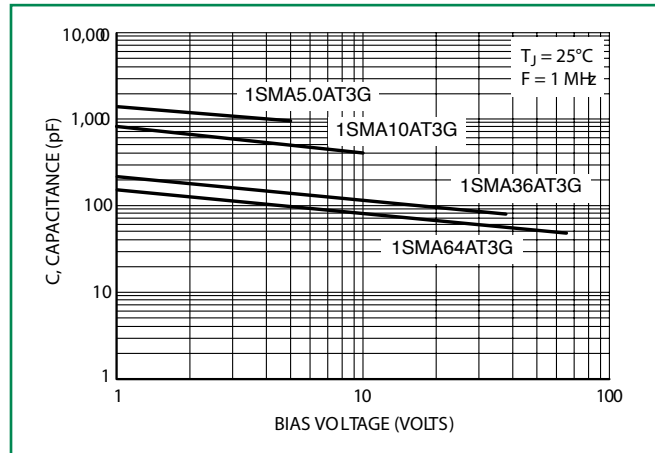

**Figure 5. Steady State Power Derating**

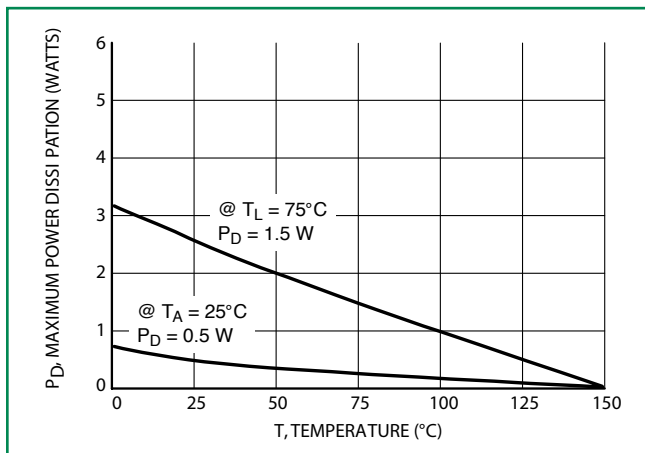

**Dimensions**

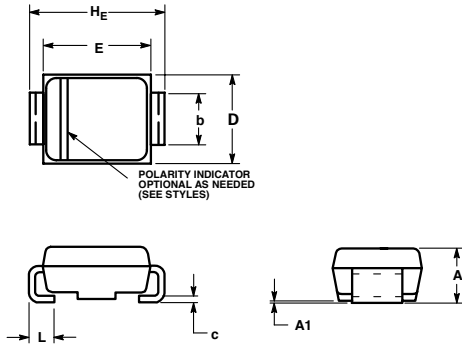

Dim	Inches			Millimeters		
	Min	Nom	Max	Min	Nom	Max
A	0.078	0.083	0.087	1.97	2.10	2.20
A1	0.002	0.004	0.008	0.05	0.10	0.20
b	0.050	0.057	0.064	1.27	1.45	1.63
c	0.006	0.011	0.016	0.15	0.28	0.41
D	0.090	0.103	0.115	2.29	2.60	2.92
E	0.160	0.170	0.180	4.06	4.32	4.57
HE	0.190	0.205	0.220	4.83	5.21	5.59
L	0.030	0.045	0.060	0.76	1.14	1.52

**NOTES:**

1. DIMENSIONING AND TOLERANCING PER ANSI Y14.5M, 1982.
2. CONTROLLING DIMENSION: INCH.
3. DIMENSION b SHALL BE MEASURED WITHIN DIMENSION L.

**STYLE 1:**

1. PIN 1. CATHODE (POLARITY BAND)
2. ANODE

**Part Marking System**

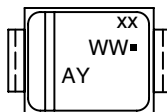

- xx = Device Code (Refer to page 3)
- A= Assembly Location
- Y= Year
- WW = Work Week
- = Pb-Free Package

**Soldering Footprint**

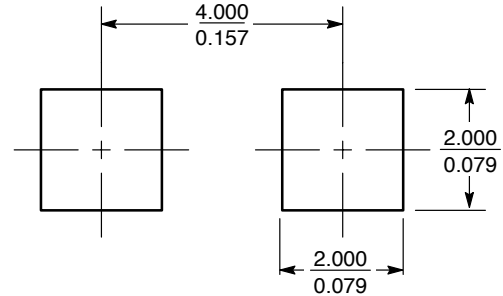

SCALE 8:1 (mm/inches)

**ORDERING INFORMATION**

Device	Package	Shipping†
SZ1SMAxxAT3G	SMA (Pb-Free)	5,000 / Tape & Reel

**Flow/Wave Soldering (Solder Dipping)**

<b>Peak Temperature :</b>	260°C
<b>Dipping Time :</b>	10 seconds

**Physical Specifications**

<b>Case</b>	Void-free, transfer-molded, thermosetting plastic
<b>Polarity</b>	Cathode indicated by molded polarity notch
<b>Mounting Position</b>	Any
<b>Finish</b>	All external surfaces are corrosion resistant and leads are readily solderable

**Disclaimer Notice** - Information furnished is believed to be accurate and reliable. However, users should independently evaluate the suitability of and test each product selected for their own applications. Littelfuse products are not designed for, and may not be used in, all applications. Read complete Disclaimer Notice at: [www.littelfuse.com/disclaimer-electronics](http://www.littelfuse.com/disclaimer-electronics).

## X-ON Electronics

Largest Supplier of Electrical and Electronic Components

*Click to view similar products for [Littelfuse](#) manufacturer:*

Other Similar products are found below :

[SMAJ7.5C](#) [SMAJ7.0C](#) [SMAJ60](#) [LT60100FBC](#) [LT60200-1C](#) [0215015.MRET1P](#) [0235.500MXP](#) [02393.15HXP](#) [02400107P](#) [740GN](#) [900-166H-031GN](#) [RA30391121](#) [127.002](#) [DUR60120W](#) [1.5KE110A-B](#) [1.5KE220CA-B](#) [1.5KE540CA](#) [BBS1A05A10](#) [BBS1A12A10](#) [P6KE27CA](#) [224001P](#) [235.200](#) [KLDR07.5TXP](#) [L70S250.V](#) [SMBJ350A](#) [LSP10347P](#) [FLSR200](#) [21701.6-P](#) [224007](#) [CCMR050.T](#) [2410SFV3.00FM/125-2](#) [257030](#) [281005](#) [GTCA28-312L-R03](#) [H-34](#) [Q201E3RP](#) [313.25](#) [LT60200FBC](#) [353001](#) [35413150029](#) [357006](#) [362001](#) [37012000430](#) [MAHC0001TXJ](#) [333.750](#) [3455LS1](#) [345903A](#) [36915000000](#) [37000500410](#) [37211600411](#)