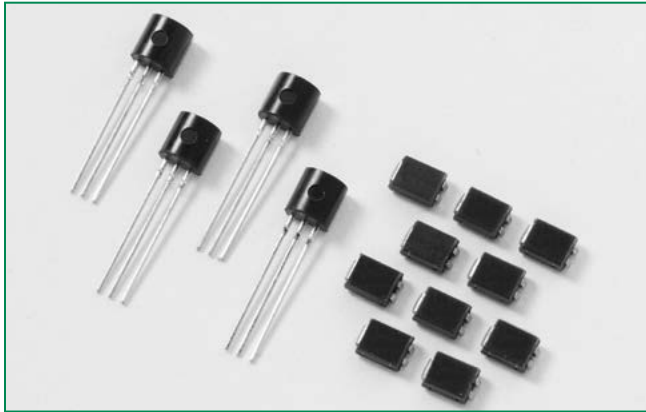


**TCR22-x & Sx02CSx series**

RoHS


**Description**

Excellent unidirectional switches for phase control applications such as heating and motor speed controls. Sensitive gate SCRs are easily triggered with microAmps of current as furnished by sense coils, proximity switches, and microprocessors.

**Features & Benefits**

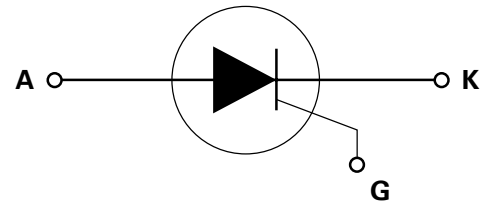
- RoHS compliant
- Glass – passivated junctions
- Voltage capability up to 600 V
- Surge capability up to 20 A

**Main Features**

Symbol	Value	Unit
$I_{T(RMS)}$	1.5	A
$V_{DRM}/V_{RRM}$	400 or 600	V
$I_{GT}$	200	$\mu A$

**Applications**

Typical applications are capacitive discharge systems for strobe lights and gas engine ignition. Also controls for power tools, home/brown goods and white goods appliances.

**Schematic Symbol**

**Absolute Maximum Ratings – Sensitive SCRs**

Symbol	Parameter	Test Conditions	Value	Unit
$I_{T(RMS)}$	RMS on-state current	$T_C = 40^\circ C$	1.5	A
$I_{T(AV)}$	Average on-state current	$T_C = 40^\circ C$	0.95	A
$I_{TSM}$	Peak non-repetitive surge current	single half cycle; $f = 50\text{Hz}$ ; $T_J(\text{initial}) = 25^\circ C$	16	A
		single half cycle; $f = 60\text{Hz}$ ; $T_J(\text{initial}) = 25^\circ C$	20	
$I^2t$	$I^2t$ Value for fusing	$t_p = 8.3\text{ ms}$	1.6	$A^2s$
$di/dt$	Critical rate of rise of on-state current	$f = 60\text{ Hz}$ ; $T_J = 110^\circ C$	50	$A/\mu s$
$I_{GM}$	Peak gate current	$T_J = 110^\circ C$	1	A
$P_{G(AV)}$	Average gate power dissipation	$T_J = 110^\circ C$	0.1	W
$T_{stg}$	Storage temperature range		-40 to 150	$^\circ C$
$T_J$	Operating junction temperature range		-40 to 110	$^\circ C$

### Electrical Characteristics ( $T_J = 25^\circ\text{C}$ , unless otherwise specified)

Symbol	Test Conditions			Value	Unit
$I_{GT}$	$V_D = 6\text{V}; R_L = 100\ \Omega$		MAX.	200	$\mu\text{A}$
$V_{GT}$			MAX.	0.8	V
dv/dt	$V_D = V_{DRM}; R_{GK} = 1\text{k}\Omega$	400V	MIN.	40	V/ $\mu\text{s}$
		600V		30	
$V_{GD}$	$V_D = V_{DRM}; R_L = 3.3\ \text{k}\Omega; T_J = 110^\circ\text{C}$		MIN.	0.25	V
$V_{GRM}$	$I_{GR} = 10\ \mu\text{A}$		MIN.	6	V
$I_H$	$I_T = 200\text{mA}$ (initial)		MAX.	5	mA
$t_g$	(1)		MAX.	50	$\mu\text{s}$
$t_{gt}$	$I_G = 2 \times I_{GT}; \text{PW} = 15\ \mu\text{s}; I_T = 3\text{A}$		TYP.	20	$\mu\text{s}$

(1)  $I_T = 1\text{A}; t_p = 50\ \mu\text{s}; \text{dv/dt} = 5\text{V}/\mu\text{s}; \text{di/dt} = -10\text{A}/\mu\text{s}$

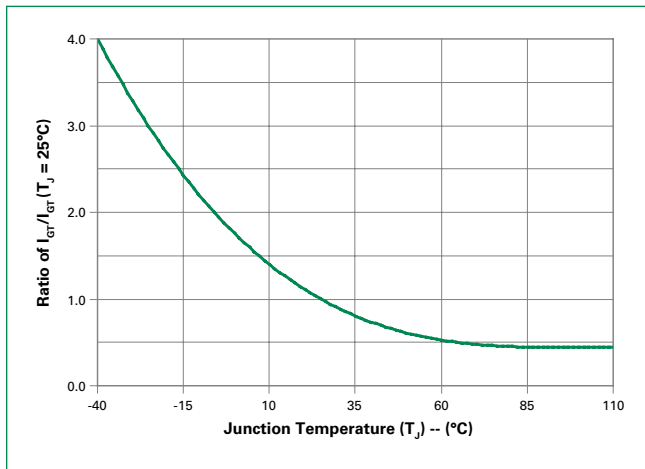
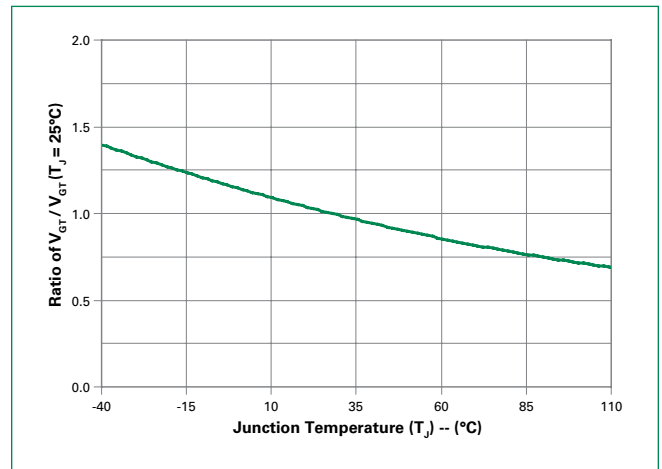
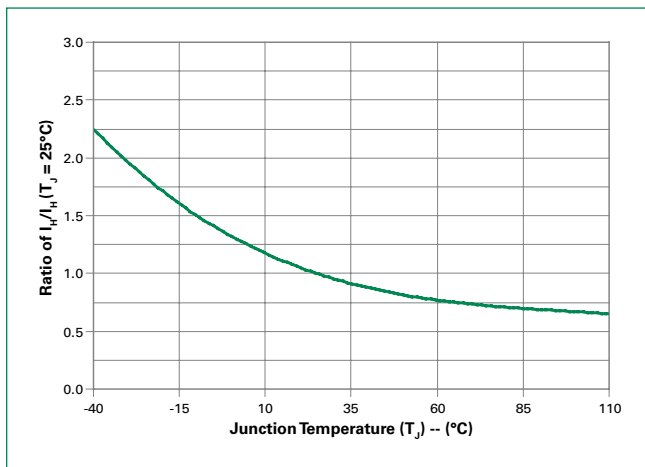
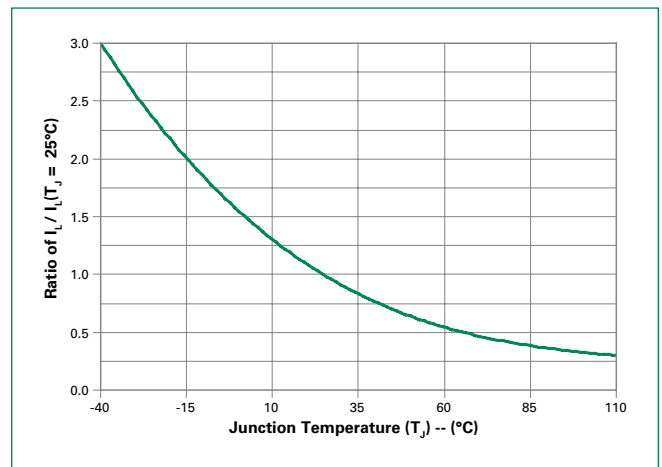
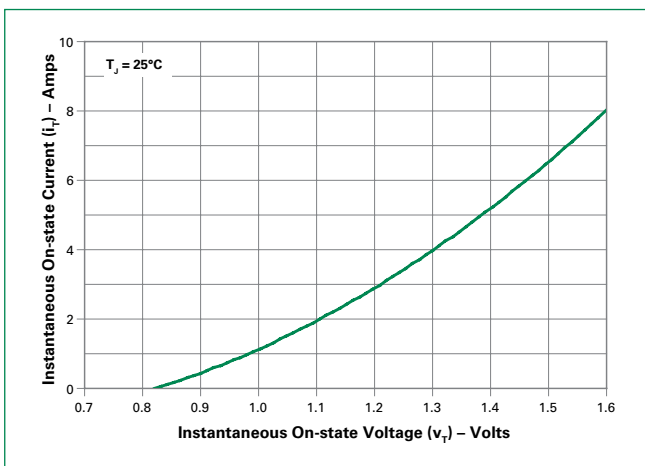
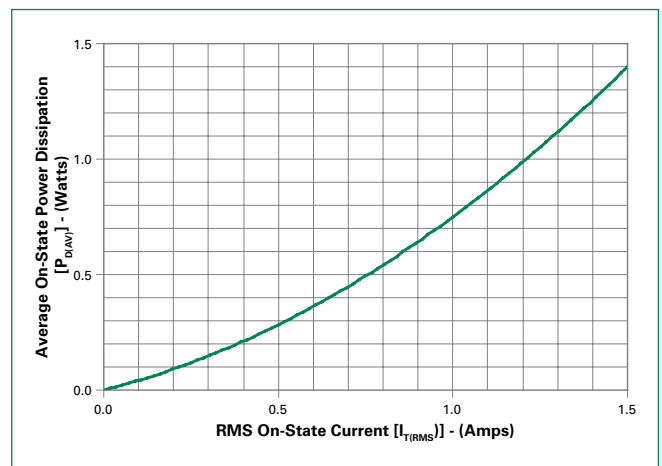
### Static Characteristics

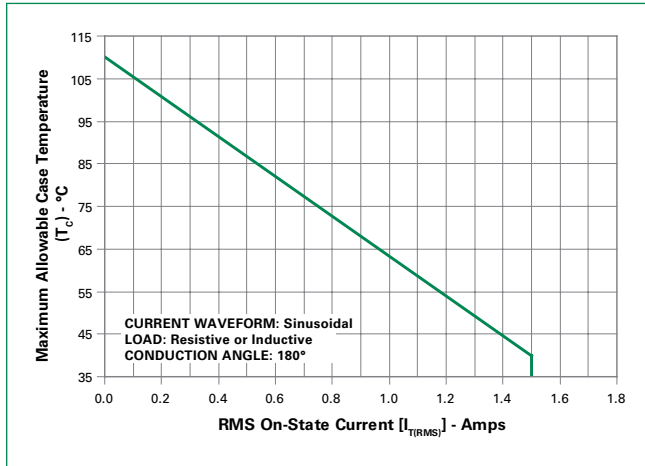
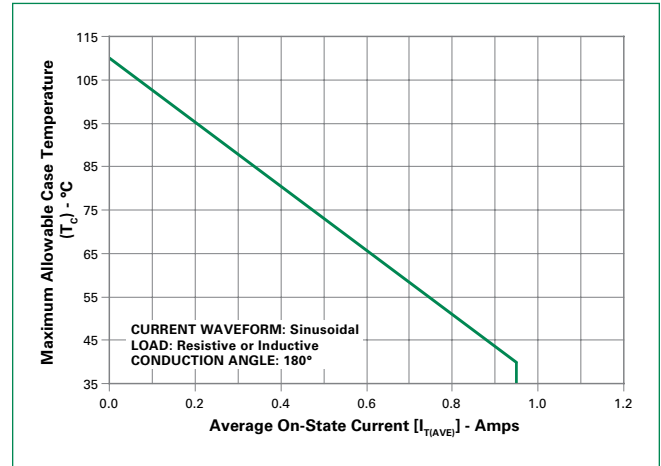
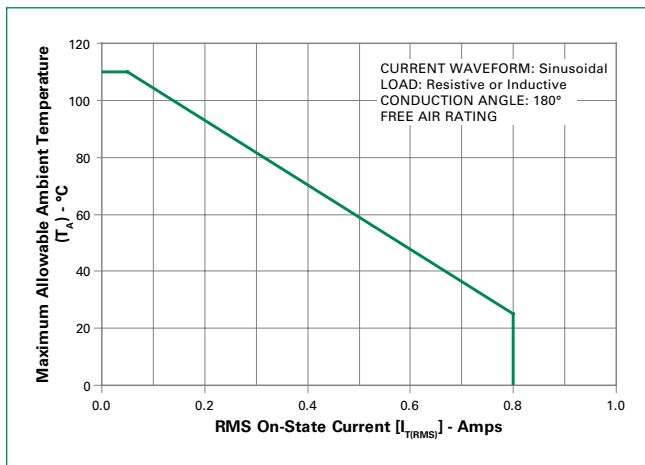
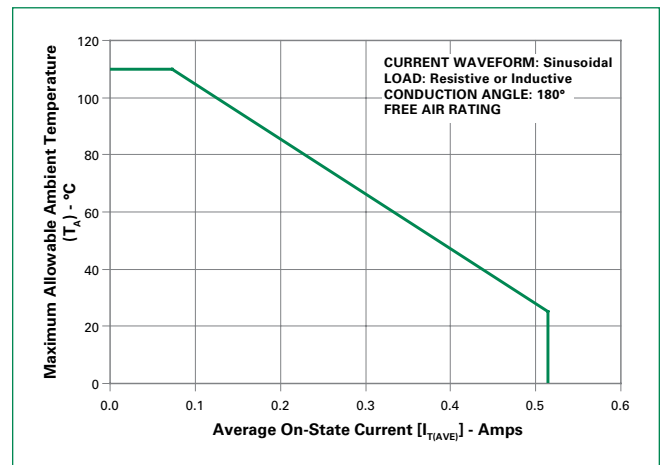
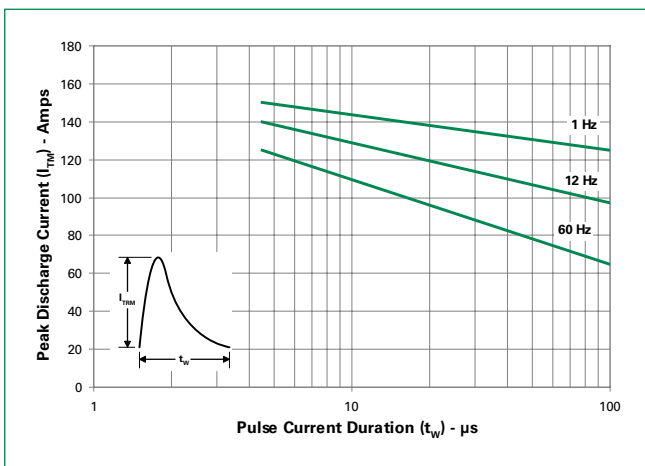
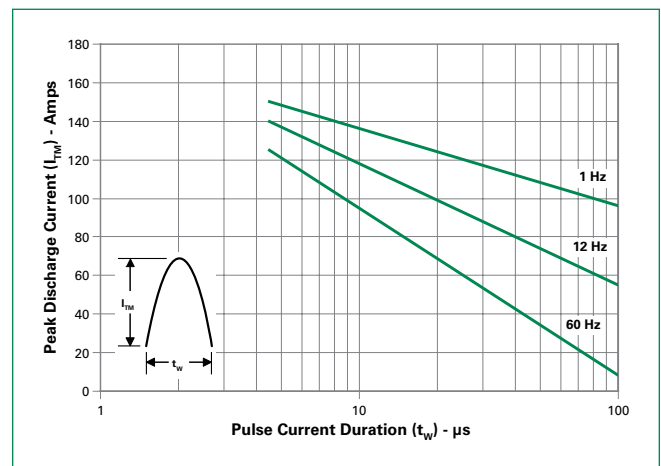
Symbol	Test Conditions			Value	Unit
$V_{TM}$	$I_T = 3\text{A}; t_p = 380\ \mu\text{s}$		MAX.	1.5	V
$I_{DRM} / I_{RRM}$	$V_{DRM} = V_{RRM}$	$T_J = 25^\circ\text{C}$	MAX.	400V	1
				600V	2
		$T_J = 110^\circ\text{C}$		100	

### Thermal Resistances

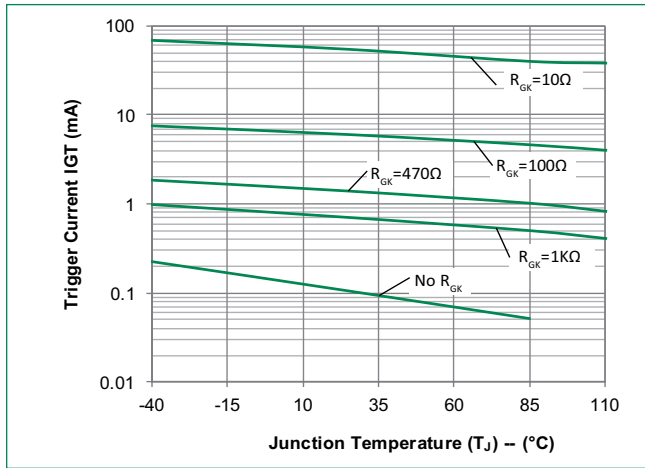
Symbol	Parameter		Value	Unit
$R_{\theta(JC)}$	Junction to case (AC)	TCR22-x	50	$^\circ\text{C}/\text{W}$
		Sx02CSx	60*	
$R_{\theta(J-A)}$	Junction to ambient	TCR22-x	160	$^\circ\text{C}/\text{W}$

\*=Mount on 1 cm<sup>2</sup> copper (two-ounce) foil surface

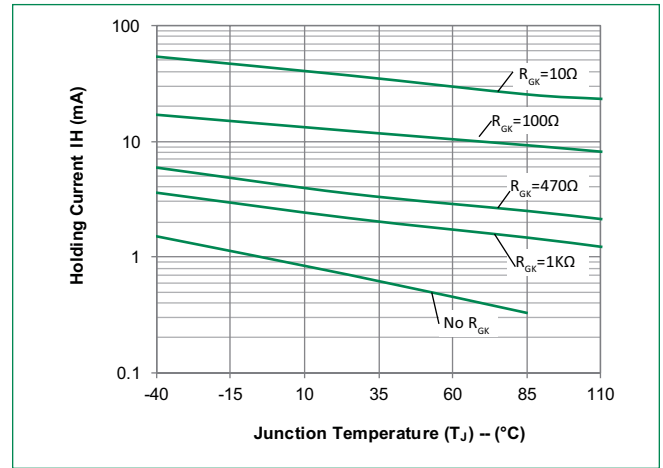
**Figure 1: Normalized DC Gate Trigger Current vs. Junction Temperature**

**Figure 2: Normalized DC Gate Trigger Voltage vs. Junction Temperature**

**Figure 3: Normalized DC Holding Current vs. Junction Temperature**

**Figure 4: Normalized DC Latching Current vs. Junction Temperature**

**Figure 5: On-State Current vs. On-State Voltage (Typical)**

**Figure 6: Power Dissipation (Typical) vs. RMS On-State Current**


**Figure 7: Maximum Allowable Case Temperature vs. RMS On-State Current**

**Figure 8: Maximum Allowable Case Temperature vs. Average On-State Current**

**Figure 9: Maximum Allowable Ambient Temperature vs. RMS On-State Current**

**Figure 10: Maximum Allowable Ambient Temperature vs. Average On-State Current**

**Figure 11: Peak Repetitive Capacitor Discharge Current**

**Figure 12: Peak Repetitive Sinusoidal Pulse Current**


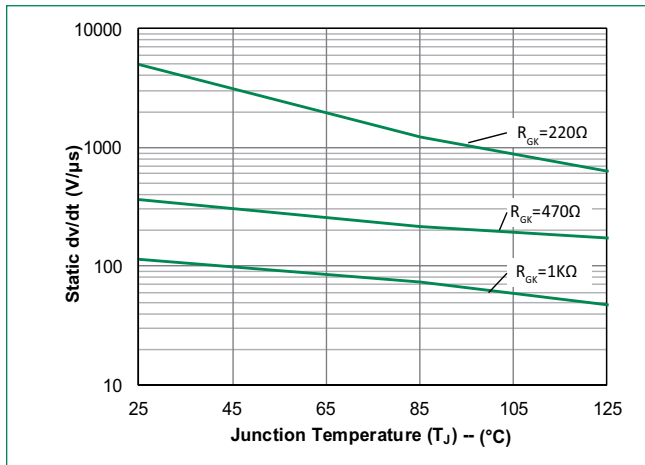
**Figure 13: Typical DC Gate Trigger Current with  $R_{GK}$  vs. Junction Temperature for TCR22-8/S602CS**



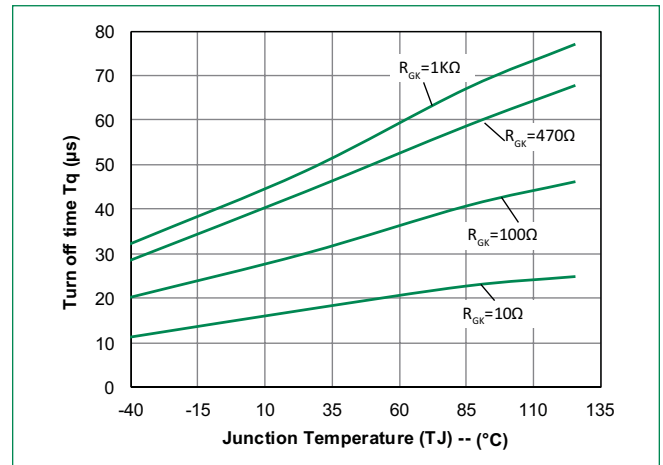
**Figure 14: Typical DC Holding Current with  $R_{GK}$  vs. Junction Temperature for TCR22-8/S602CS**



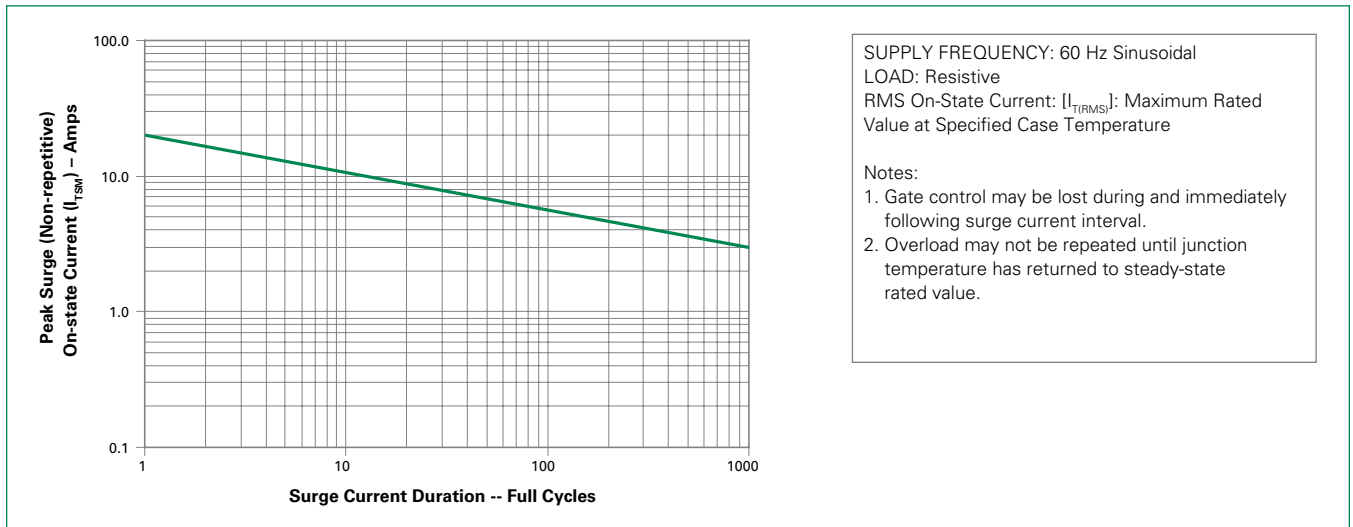
**Figure 15: Typical Static dv/dt with  $R_{GK}$  vs. Junction Temperature for TCR22-8/S602CS**

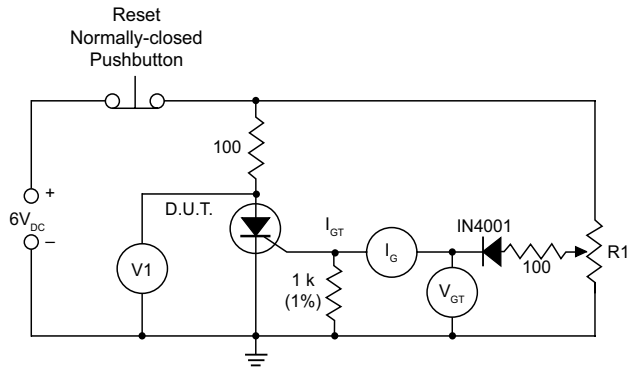


**Figure 16: Typical turn off time with  $R_{GK}$  vs. Junction Temperature for TCR22-8/S602CS**



**Figure 17: Surge Peak On-State Current vs. Number of Cycles**



**Figure 18: Simple Test Circuit for Gate Trigger Voltage and Current**


Note: V1 — 0 V to 10 V dc meter  
 V<sub>GT</sub> — 0 V to 1 V dc meter  
 I<sub>G</sub> — 0 mA to 1 mA dc milliammeter  
 R1 — 1 k potentiometer

To measure gate trigger voltage and current, raise gate voltage (V<sub>GT</sub>) until meter reading V1 drops from 6 V to 1 V. Gate trigger voltage is the reading on V<sub>GT</sub> just prior to V1 dropping. Gate trigger current I<sub>GT</sub> can be computed from the relationship

$$I_{GT} = I_G \frac{V_{GT}}{1000} \text{ Amps}$$

where I<sub>G</sub> is reading (in amperes) on meter just prior to V1 dropping

Note: I<sub>GT</sub> may turn out to be a negative quantity (trigger current flows out from gate lead). If negative current occurs, I<sub>GT</sub> value is not a valid reading. Remove 1 k resistor and use I<sub>G</sub> as the more correct I<sub>GT</sub> value. This will occur on 12 μA gate products.

### Soldering Parameters

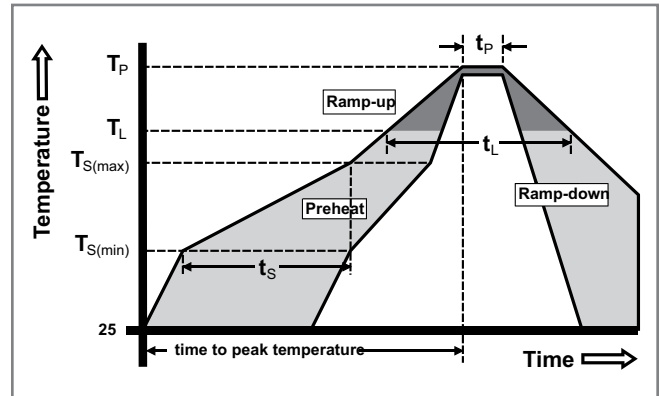
Reflow Condition		Pb – Free assembly
Pre Heat	-Temperature Min (T <sub>s(min)</sub> )	150°C
	-Temperature Max (T <sub>s(max)</sub> )	200°C
	-Time (min to max) (t <sub>s</sub> )	60 – 180 secs
Average ramp up rate (Liquidus Temp (T <sub>L</sub> ) to peak)		5°C/second max
T <sub>s(max)</sub> to T <sub>L</sub> - Ramp-up Rate		5°C/second max
Reflow	-Temperature (T <sub>L</sub> ) (Liquidus)	217°C
	-Time (t <sub>r</sub> )	60 – 150 seconds
Peak Temperature (T <sub>p</sub> )		260 <sup>+0/-5</sup> °C
Time within 5°C of actual peak Temperature (t <sub>p</sub> )		20 – 40 seconds
Ramp-down Rate		5°C/second max
Time 25°C to peak Temperature (T <sub>p</sub> )		8 minutes Max.
Do not exceed		280°C

### Physical Specifications

<b>Terminal Finish</b>	100% Matt Tin-plated/Pb-free Solder Dipped
<b>Body Material</b>	UL Recognized compound meeting flammability rating V-0
<b>Lead Material</b>	Copper Alloy

### Design Considerations

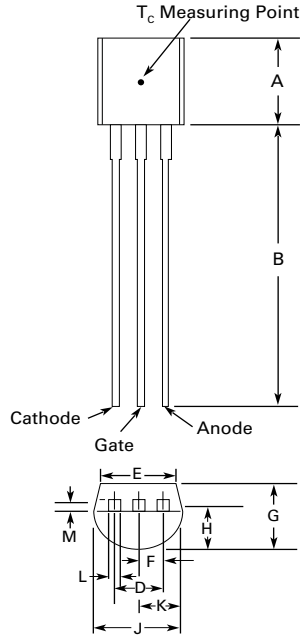
Careful selection of the correct component for the application's operating parameters and environment will go a long way toward extending the operating life of the Thyristor. Good design practice should limit the maximum continuous current through the main terminals to 75% of the component rating. Other ways to ensure long life for a power discrete semiconductor are proper heat sinking and selection of voltage ratings for worst case conditions. Overheating, overvoltage (including dv/dt), and surge currents are the main killers of semiconductors. Correct mounting, soldering, and forming of the leads also help protect against component damage.



### Environmental Specifications

Test	Specifications and Conditions
<b>AC Blocking</b>	MIL-STD-750, M-1040, Cond A Applied Peak AC voltage @ 110°C for 1008 hours
<b>Temperature Cycling</b>	MIL-STD-750, M-1051, 100 cycles; -40°C to +150°C; 15-min dwell-time
<b>Temperature/Humidity</b>	EIA / JEDEC, JESD22-A101 1008 hours; 160V - DC; 85°C; 85% rel humidity
<b>High Temp Storage</b>	MIL-STD-750, M-1031, 1008 hours; 150°C
<b>Low-Temp Storage</b>	1008 hours; -40°C
<b>Resistance to Solder Heat</b>	MIL-STD-750 Method 2031
<b>Solderability</b>	ANSI/J-STD-002, category 3, Test A
<b>Lead Bend</b>	MIL-STD-750, M-2036 Cond E

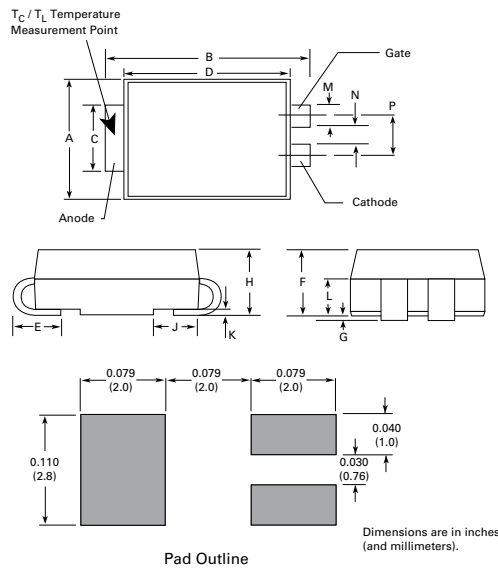
### Dimensions – TO-92 (E Package)



Dimension	Inches		Millimeters	
	Min	Max	Min	Max
A	0.176	0.196	4.47	4.98
B	0.500		12.70	
D	0.095	0.105	2.41	2.67
E	0.150		3.81	
F	0.046	0.054	1.16	1.37
G	0.135	0.145	3.43	3.68
H	0.088	0.096	2.23	2.44
J	0.176	0.186	4.47	4.73
K	0.088	0.096	2.23	2.44
L	0.013	0.019	0.33	0.48
M	0.013	0.017	0.33	0.43

All leads insulated from case. Case is electrically nonconductive.

### Dimensions – Compak (C Package)



Dimension	Inches		Millimeters	
	Min	Max	Min	Max
A	0.130	0.156	3.30	3.95
B	0.201	0.220	5.10	5.60
C	0.077	0.087	1.95	2.20
D	0.159	0.181	4.05	4.60
E	0.030	0.063	0.75	1.60
F	0.075	0.096	1.90	2.45
G	0.002	0.008	0.05	0.20
H	0.077	0.104	1.95	2.65
J	0.043	0.053	1.09	1.35
K	0.006	0.016	0.15	0.41
L	0.030	0.055	0.76	1.40
M	0.022	0.028	0.56	0.71
N	0.027	0.033	0.69	0.84
P	0.052	0.058	1.32	1.47

### Product Selector

Part Number	Voltage		Gate Sensitivity	Type	Package
	400V	600V			
TCR22-6	X		200μA	Sensitive SCR	TO-92
TCR22-8		X	200μA	Sensitive SCR	TO-92
Sx02CS		X	200μA	Sensitive SCR	Compak

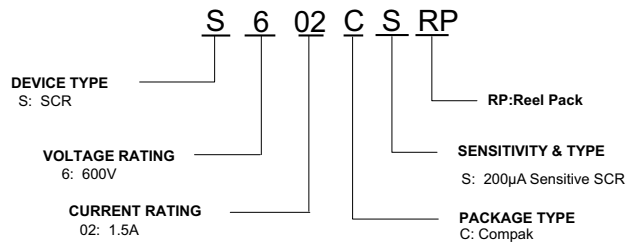
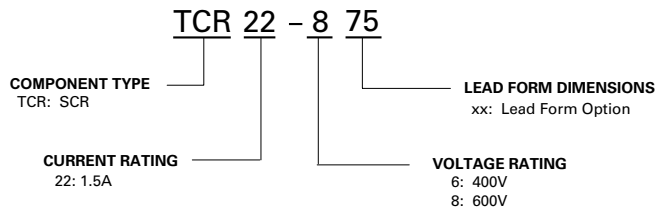
Note: x = Voltage

### Packing Options

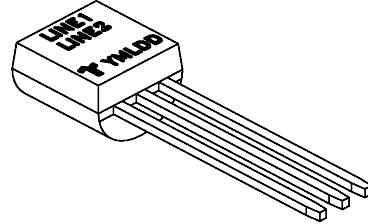
Part Number	Marking	Weight	Packing Mode	Base Quantity
TCR22-x	TCR22-x	0.19 g	Bulk	2000
TCR22-xRP	TCR22-x	0.19 g	Reel Pack	2000
TCR22-xAP	TCR22-x	0.19 g	Ammo Pack	2000
Sx02CSR	Sx02CS	0.18 g	Reel Pack	2500

Note: x = Voltage

### Part Numbering System



### Part Marking System



Line1 = Littelfuse Part Number  
 Line2 = continuation...Littelfuse Part Number  
 Y = Last Digit of Calendar Year  
 M = Letter Month Code (A-L for Jan-Dec)  
 L = Location Code  
 DD = Calendar Date

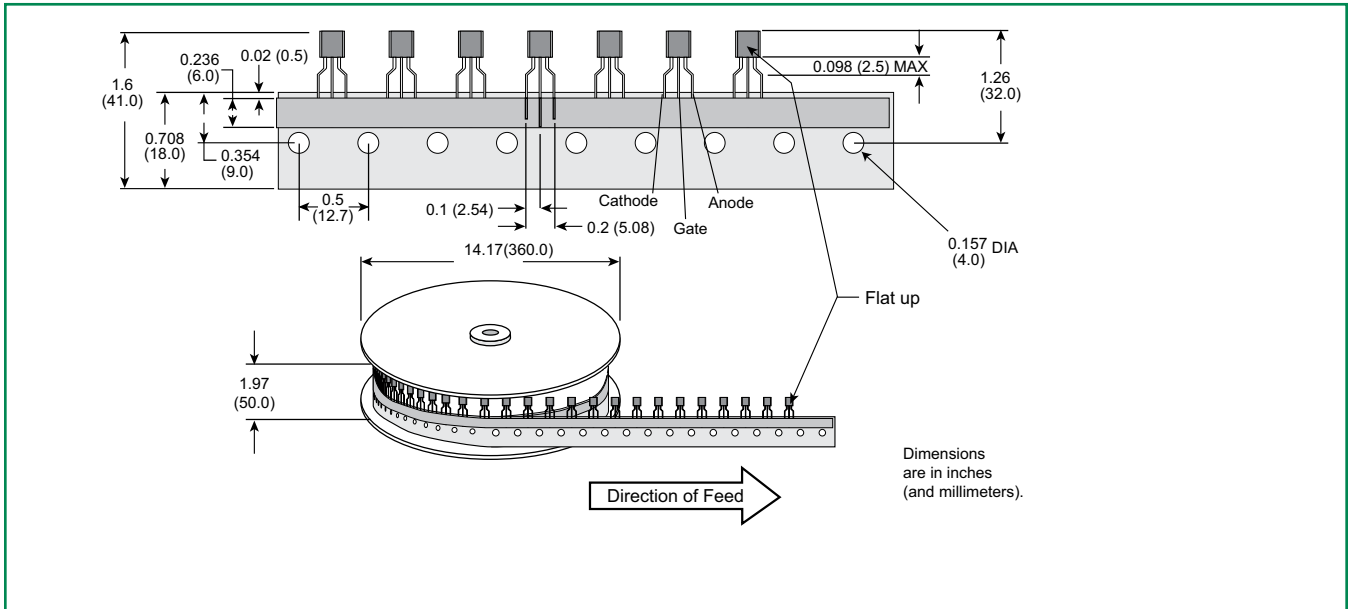


**Date Code Marking**  
 Y: Year Code  
 M: Month Code  
 XXX: Lot Trace Code



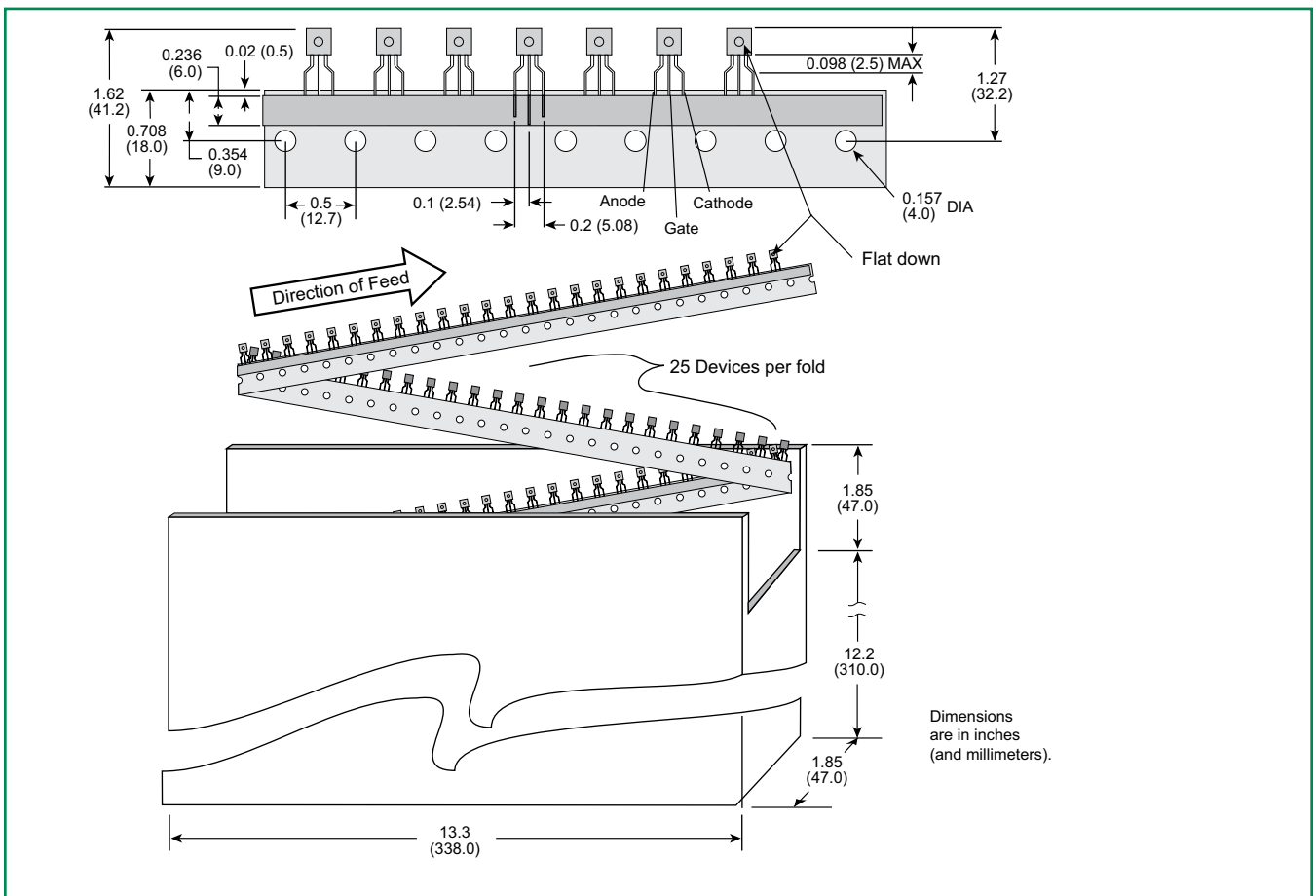
### TO-92 (3-lead) Reel Pack (RP) Radial Leaded Specifications

Meets all EIA-468-C Standards



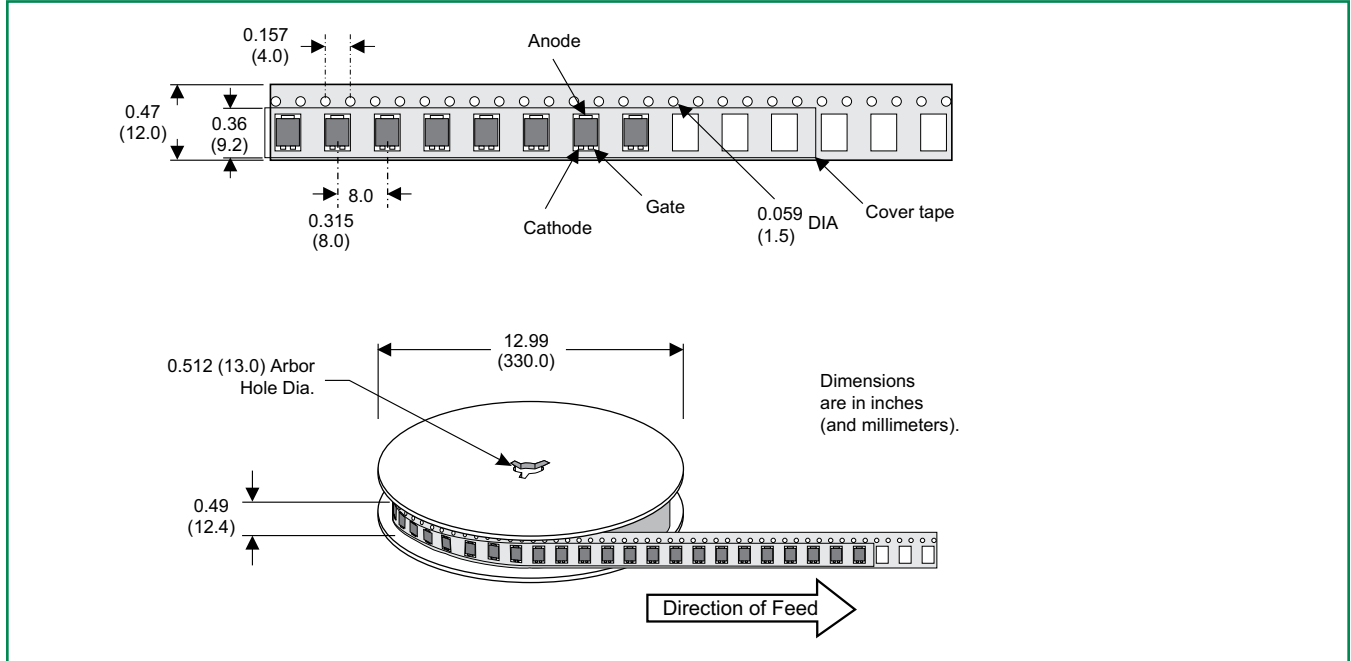
### TO-92 (3-lead) Ammo Pack (AP) Radial Leaded Specifications

Meets all EIA-468-C Standards



### Compak Embossed Carrier Reel Pack (RP) Specifications

Meets all EIA-481-1 Standards



**Disclaimer Notice - Information furnished is believed to be accurate and reliable. However, users should independently evaluate the suitability of and test each product selected for their own applications. Littelfuse products are not designed for, and may not be used in, all applications. Read complete Disclaimer Notice at <http://www.littelfuse.com/disclaimer-electronics>.**

## X-ON Electronics

Largest Supplier of Electrical and Electronic Components

*Click to view similar products for [SCRs category](#):*

*Click to view products by [Littelfuse manufacturer](#):*

Other Similar products are found below :

[NTE5428](#) [T1500N16TOF VT](#) [TT162N16KOF-A](#) [TT162N16KOF-K](#) [TT330N16AOF](#) [VS-22RIA20](#) [VS-2N685](#) [057219R](#) [T1190N16TOF VT](#)  
[T1220N22TOF VT](#) [T201N70TOH](#) [T700N22TOF](#) [T830N18TOF](#) [TT250N12KOF-K](#) [VS-16RIA120](#) [VS-110RKI40](#) [NTE5427](#) [NTE5442](#)  
[TT251N16KOF-K](#) [VS-22RIA100](#) [VS-16RIA40](#) [TD250N16KOF-A](#) [VS-ST110S16P0](#) [T930N36TOF VT](#) [T2160N24TOF VT](#) [T1190N18TOF](#)  
[VT](#) [T1590N28TOF VT](#) [2N1776A](#) [T590N14TOF](#) [NTE5375](#) [NTE5460](#) [NTE5481](#) [NTE5512](#) [NTE5514](#) [NTE5518](#) [NTE5519](#) [NTE5529](#)  
[NTE5553](#) [NTE5555](#) [NTE5557](#) [NTE5567](#) [NTE5570](#) [NTE5572](#) [NTE5574](#) [NTE5576](#) [NTE5578](#) [NTE5579](#) [NTE5589](#) [NTE5592](#) [NTE5598](#)