

C-III Series

Radial Leaded Varistors



Description

The C-III Varistor Series of Metal-Oxide Varistors (MOVs) are specifically designed for applications requiring high surge energy absorption ratings and superior multiple pulse absorption rating. This is achieved through a special dielectric material formulation which also results in higher repetitive surge ratings than other MOV types.

The C-III Varistor Series is primarily intended for use in AC line Surge Protection Device (SPD) product and other similar applications requiring high transient energy and peak current capability in a relatively small package size.

Features & Benefits

- Lead-free, Halogen-Free and RoHS compliant
- High energy absorption capability WTM 40J to 530J (2ms)
- High pulse life rating
- High peak pulse current capability
- ITM 3500A to 10,000A (8/20 μ s)
- Wide operating voltage range VM(AC)RMS 130V to 1000V
- Available in tape and reel for automatic insertion; Also available with crimped and/or trimmed lead styles
- No derating up to 85°C ambient
- The C-III Series is supplied in 10mm, 14mm and 20mm disc versions with various lead options

Additional Information



Resources



Accessories



Samples

Agency Approvals

| Agency | Agency Approval | Agency File Number |
|--------|--|--------------------|
| | UL1449 | E320116 |
| | CECC 42201-006 IEC 61051-1 IEC 61051-2 IEC 60950-1 (Annex Q) for 14mm and 20mm only | 116895 |
| | CECC 42201-006 IEC 61051-1 IEC 61051-2 IEC 60950-1 (Annex Q) for 14mm and 20mm only | E1273/F |

Absolute Maximum Ratings

For ratings of individual members of a series, see Device Ratings and Specifications chart

| Continuous | C-III Series | Units |
|--|----------------|------------|
| Steady State Applied Voltage | | |
| AC Voltage Range ($V_{M(AC)RMS}$) | 130 to 1000 | V |
| Transients | | |
| Single-Pulse Peak Current (I_{TM}) 8/20 μ s Wave (See Peak Pulse Current Test Waveform) | 3500 to 10,000 | A |
| Single-Pulse Energy Range (W_{TM}) 2ms Rectangular Wave | 40 to 530 | J |
| Operating Ambient Temperature Range (T_A) | -55 to +85 | °C |
| Storage Temperature Range (T_{STG}) | -55 to +125 | °C |
| Temperature Coefficient (α^V) of Clamping Voltage (V_C) at Specified Test Current | <0.01 | %/°C |
| Hi-Pot Encapsulation (COATING Isolation Voltage Capability) | 2500 | V |
| COATING Insulation Resistance | 1000 | M Ω |

Caution: Stresses above those listed in "Absolute Maximum Ratings" may cause permanent damage to the device. This is a stress only rating and operation of the device at these or any other conditions above those indicated in the operational sections of this specification is not implied.

C-III Series

Radial Leaded Varistors

C-III Series Ratings

| Part Number | Branding | Disc Size (mm) | Maximum Ratings (85 °C) | | | | | Specifications (25 °C) | | | | | | |
|----------------|----------|----------------|--------------------------------------|--|-----------------------|------------------------|---------------|---|-----------|-----------------------------------|-----------------------|-------------------------|--|--|
| | | | Continuous | | Transient | | | Varistor Voltage at 1mA DC Test Current | | Maximum Clamping Voltage (8/20µs) | | Duty Cycle Surge Rating | | |
| | | | Maximum V_{RMS} $V_{M(AC)}$ (V) | Withstanding Energy (2ms) W_{TM} (J) | Peak Current (8/20µs) | | | | | | | | | |
| | | | | | I_{TM1} 1 Pulse (A) | I_{TM2} 2 Pulses (A) | V_N Min (V) | V_N Max (V) | V_C (V) | I_P (A) | 3kA (8/20µs) # Pulses | 750A (8/20µs) # Pulses | | |
| V130LA5CP | P130L5C | 10 | 130 | 40 | 3500 | 3000 | 184.5 | 225.5 | 340 | 25 | 2 | 20 | | |
| V130LA10CP | P130L10C | 14 | 130 | 80 | 6500 | 5000 | 184.5 | 225.5 | 340 | 50 | 15 | 80 | | |
| V130LA20CP | P130L20C | 20 | 130 | 200 | 10000 | 7000 | 184.5 | 225.5 | 340 | 100 | 20 | 120 | | |
| V130LA20CPX325 | P130X325 | 20 | 130 | 200 | 10000 | 7000 | 190 | 220 | 325 | 100 | 20 | 120 | | |
| V140LA5CP | P140L5C | 10 | 140 | 45 | 3500 | 3000 | 198 | 242 | 360 | 25 | 2 | 20 | | |
| V140LA10CP | P140L10C | 14 | 140 | 90 | 6500 | 5000 | 198 | 242 | 360 | 50 | 15 | 80 | | |
| V140LA20CP | P140L20C | 20 | 140 | 210 | 10000 | 7000 | 198 | 242 | 360 | 100 | 20 | 120 | | |
| V140LA20CPX340 | P140X340 | 20 | 140 | 210 | 10000 | 7000 | 198 | 230 | 340 | 100 | 20 | 120 | | |
| V150LA5CP | P150L5C | 10 | 150 | 50 | 3500 | 3000 | 216.0 | 264.0 | 395 | 25 | 2 | 20 | | |
| V150LA10CP | P150L10C | 14 | 150 | 100 | 6500 | 5000 | 216.0 | 264.0 | 395 | 50 | 15 | 80 | | |
| V150LA20CP | P150L20C | 20 | 150 | 215 | 10000 | 7000 | 216.0 | 264.0 | 395 | 100 | 20 | 120 | | |
| V150LA20CPX360 | P150X360 | 20 | 150 | 215 | 10000 | 7000 | 216 | 243 | 360 | 100 | 20 | 120 | | |
| V175LA5CP | P175L5C | 10 | 175 | 55 | 3500 | 3000 | 243 | 297 | 455 | 25 | 2 | 20 | | |
| V175LA10CP | P175L10C | 14 | 175 | 110 | 6500 | 5000 | 243 | 297 | 455 | 50 | 15 | 80 | | |
| V175LA20CP | P175L20C | 20 | 175 | 220 | 10000 | 7000 | 243 | 297 | 455 | 100 | 20 | 120 | | |
| V175LA20CPX425 | P175X425 | 20 | 175 | 220 | 10000 | 7000 | 247 | 285 | 425 | 100 | 20 | 120 | | |
| V230LA10CP | P230L10C | 10 | 230 | 60 | 3500 | 3000 | 324 | 396 | 595 | 25 | 2 | 20 | | |
| V230LA20CP | P230L20C | 14 | 230 | 125 | 6500 | 5000 | 324 | 396 | 595 | 50 | 15 | 80 | | |
| V230LA40CP | P230L40C | 20 | 230 | 280 | 10000 | 7000 | 324 | 396 | 595 | 100 | 20 | 120 | | |
| V230LA40CPX570 | P230X570 | 20 | 230 | 280 | 10000 | 7000 | 324 | 384 | 570 | 100 | 20 | 120 | | |
| V250LA10CP | P250L10C | 10 | 250 | 65 | 3500 | 3000 | 351 | 429 | 650 | 25 | 2 | 20 | | |
| V250LA20CP | P250L20C | 14 | 250 | 135 | 6500 | 5000 | 351 | 429 | 650 | 50 | 15 | 80 | | |
| V250LA40CP | P250L40C | 20 | 250 | 300 | 10000 | 7000 | 351 | 429 | 650 | 100 | 20 | 120 | | |
| V250LA40CPX620 | P250X620 | 20 | 250 | 300 | 10000 | 7000 | 354 | 413 | 620 | 100 | 20 | 120 | | |
| V275LA10CP | P275L10C | 10 | 275 | 70 | 3500 | 3000 | 387 | 473 | 710 | 25 | 2 | 20 | | |
| V275LA20CP | P275L20C | 14 | 275 | 145 | 6500 | 5000 | 387 | 473 | 710 | 50 | 15 | 80 | | |
| V275LA40CP | P275L40C | 20 | 275 | 320 | 10000 | 7000 | 387 | 473 | 710 | 100 | 20 | 120 | | |
| V275LA40CPX680 | P275X680 | 20 | 275 | 320 | 10000 | 7000 | 389 | 453 | 680 | 100 | 20 | 120 | | |
| V300LA10CP | P300L10C | 10 | 300 | 75 | 3500 | 3000 | 423.0 | 517.0 | 775 | 25 | 2 | 20 | | |
| V300LA20CP | P300L20C | 14 | 300 | 155 | 6500 | 5000 | 423.0 | 517.0 | 775 | 50 | 15 | 80 | | |
| V300LA40CP | P300L40C | 20 | 300 | 335 | 10000 | 7000 | 423.0 | 517.0 | 775 | 100 | 20 | 120 | | |
| V300LA40CPX745 | P300X745 | 20 | 300 | 335 | 10000 | 7000 | 420 | 490 | 745 | 100 | 20 | 120 | | |
| V320LA10CP | P320L10C | 10 | 320 | 80 | 3500 | 3000 | 462.0 | 558.0 | 850 | 25 | 2 | 20 | | |
| V320LA20CP | P320L20C | 14 | 320 | 165 | 6500 | 5000 | 462.0 | 558.0 | 850 | 50 | 15 | 80 | | |
| V320LA40CP | P320L40C | 20 | 320 | 345 | 10000 | 7000 | 462.0 | 558.0 | 850 | 100 | 20 | 120 | | |
| V320LA40CPX810 | P320X810 | 20 | 320 | 345 | 10000 | 7000 | 462 | 540 | 810 | 100 | 20 | 120 | | |
| V385LA10CP | P385L10C | 10 | 385 | 85 | 3500 | 3000 | 558 | 682 | 1025 | 25 | 2 | 20 | | |
| V385LA20CP | P385L20C | 14 | 385 | 175 | 6500 | 5000 | 558 | 682 | 1025 | 50 | 15 | 80 | | |
| V385LA40CP | P385L40C | 20 | 385 | 370 | 10000 | 7000 | 558 | 682 | 1025 | 100 | 20 | 120 | | |
| V420LA10CP | P420L10C | 10 | 420 | 90 | 3500 | 3000 | 612.0 | 748.0 | 1120 | 25 | 2 | 20 | | |
| V420LA20CP | P420L20C | 14 | 420 | 185 | 6500 | 5000 | 612.0 | 748.0 | 1120 | 50 | 15 | 80 | | |
| V420LA40CP | P420L40C | 20 | 420 | 390 | 10000 | 7000 | 612.0 | 748.0 | 1120 | 100 | 20 | 120 | | |
| V460LA10CP | P460L10C | 10 | 460 | 95 | 3500 | 3000 | 643.5 | 786.5 | 1190 | 25 | 2 | 20 | | |
| V460LA20CP | P460L20C | 14 | 460 | 190 | 6500 | 5000 | 643.5 | 786.5 | 1190 | 50 | 15 | 80 | | |
| V460LA40CP | P460L40C | 20 | 460 | 430 | 10000 | 7000 | 643.5 | 786.5 | 1190 | 100 | 20 | 120 | | |

C-III Series

Radial Leaded Varistors

C-III Series Specifications (continued from previous page)

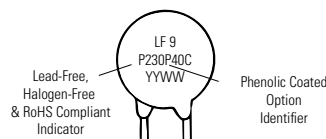
| | | | | | | | | | | | | |
|--------------|-----------|----|------|-----|-------|------|-------|--------|------|-----|----|-----|
| V480LA10CP | P480L10C | 10 | 480 | 95 | 3500 | 3000 | 675.0 | 825.0 | 1240 | 25 | 2 | 20 |
| V480LA40CP | P480L40C | 14 | 480 | 195 | 6500 | 5000 | 675.0 | 825.0 | 1240 | 50 | 15 | 80 |
| V480LA80CP | P480L80C | 20 | 480 | 420 | 10000 | 7000 | 675.0 | 825.0 | 1240 | 100 | 20 | 120 |
| V510LA10CP | P510L10C | 10 | 510 | 98 | 3500 | 3000 | 738.0 | 902.0 | 1350 | 25 | 2 | 20 |
| V510LA40CP | P510L40C | 14 | 510 | 205 | 6500 | 5000 | 738.0 | 902.0 | 1350 | 50 | 15 | 80 |
| V510LA80CP | P510L80C | 20 | 510 | 440 | 10000 | 7000 | 738.0 | 902.0 | 1350 | 100 | 20 | 120 |
| V550LA10CP | P550L10C | 10 | 550 | 98 | 3500 | 3000 | 792.0 | 968.0 | 1435 | 25 | 2 | 20 |
| V550LA40CP | P550L40C | 14 | 550 | 210 | 6500 | 5000 | 792.0 | 968.0 | 1435 | 50 | 15 | 80 |
| V550LA80CP | P550L80C | 20 | 550 | 450 | 10000 | 7000 | 792.0 | 968.0 | 1435 | 100 | 20 | 120 |
| V575LA10CP | P575L10C | 10 | 575 | 100 | 3500 | 3000 | 819.0 | 1001.0 | 1500 | 25 | 2 | 20 |
| V575LA40CP | P575L40C | 14 | 575 | 230 | 6500 | 5000 | 819.0 | 1001.0 | 1500 | 50 | 15 | 80 |
| V575LA80CP | P575L80C | 20 | 575 | 460 | 10000 | 7000 | 819.0 | 1001.0 | 1500 | 100 | 20 | 120 |
| V625LA10CP | P625L10C | 10 | 625 | 105 | 3500 | 3000 | 900 | 1100 | 1650 | 25 | 2 | 20 |
| V625LA40CP | P625L40C | 14 | 625 | 235 | 6500 | 5000 | 900 | 1100 | 1650 | 50 | 15 | 80 |
| V625LA80CP | P625L80C | 20 | 625 | 490 | 10000 | 7000 | 900 | 1100 | 1725 | 100 | 20 | 120 |
| V660LA10CP | P660L10C | 10 | 660 | 110 | 3500 | 3000 | 972.0 | 1188.0 | 1820 | 25 | 2 | 20 |
| V660LA50CP | P660L50C | 14 | 660 | 240 | 6500 | 5000 | 972.0 | 1188.0 | 1820 | 50 | 15 | 80 |
| V660LA80CP | P660L80C | 20 | 660 | 510 | 10000 | 7000 | 972.0 | 1188.0 | 1820 | 100 | 20 | 120 |
| V680LA10CP | P680L10C | 10 | 680 | 115 | 3500 | 3000 | 990.0 | 1210.0 | 1860 | 25 | 2 | 20 |
| V680LA80CP | P680L80C | 14 | 680 | 240 | 6500 | 5000 | 990 | 1210 | 1820 | 50 | 15 | 80 |
| V680LA100CP | P680L100C | 20 | 680 | 520 | 10000 | 7000 | 990 | 1130 | 1700 | 100 | 20 | 120 |
| V1000LA80CP | P1000L8C | 14 | 1000 | 260 | 6500 | 5000 | 1500 | 1800 | 2700 | 50 | 15 | 80 |
| V1000LA160CP | P1000L16C | 20 | 1000 | 530 | 10000 | 7000 | 1500 | 1800 | 2700 | 100 | 20 | 120 |

NOTES:

- Average power dissipation of transients not to exceed 0.6W and 1W for model sizes 14mm and 20mm, respectively.
- 7mm parts also available-contact factory for further information
- For additional or intermediary voltage ratings contact factory

Phenolic Coating Option -- C-III Series Varistors for Hi-Temperature Operating Conditions:

- Phenolic Coated CIII Series devices are available with improved maximum operating maximum temperature 125°C
- These devices also have improved temperature cycling performance capability.
- Ratings and Specifications are as per standard except Hi-Pot Encapsulation (Isolation Voltage Capability)=500V.
- To order: add X1347 to part number (e.g. V230LA40CPX1347)
- These devices are not UL, CSA, VDE or CECC certified.
- Contact factory for further details.
- Product marking:



C-III Series

Radial Leaded Varistors

Figure 1. Current Energy and Power Dissipation Ratings

Should transients occur in rapid succession, the average power dissipation is the energy (watt-seconds) per pulse times the number of pulses per second. The power so developed must be within the specifications shown on the Device Ratings and Specifications Table for the specific device. The operating values

of a MOV need to be derated at high temperatures as shown above. Because varistors only dissipate a relatively small amount of average power they are not suitable for repetitive applications that involve substantial amounts of average power dissipation.

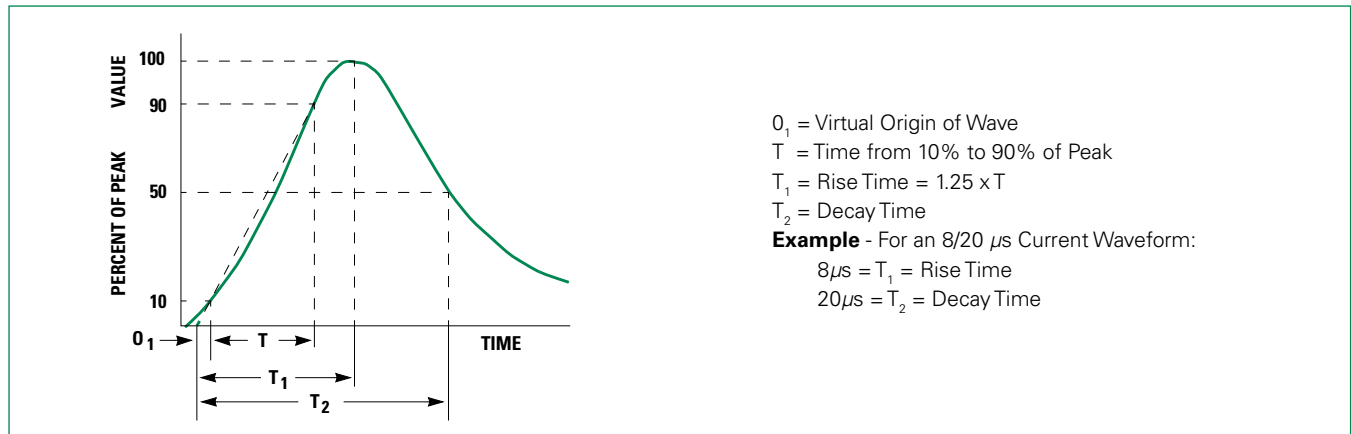
1A - Power Derating for Epoxy Coated



1B - Power Derating for Phenolic Coated

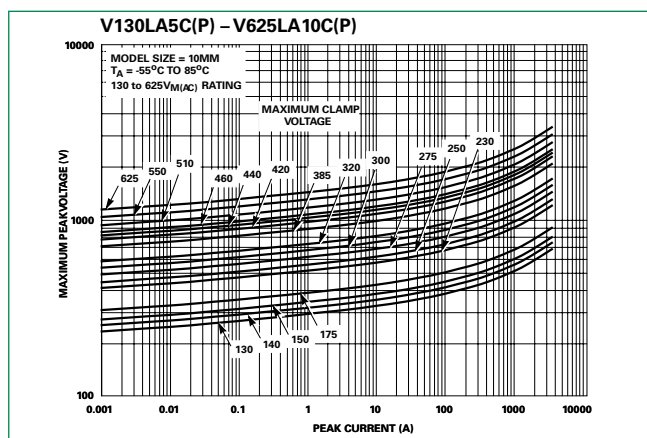


Figure 2. Peak Pulse Current Test Waveform



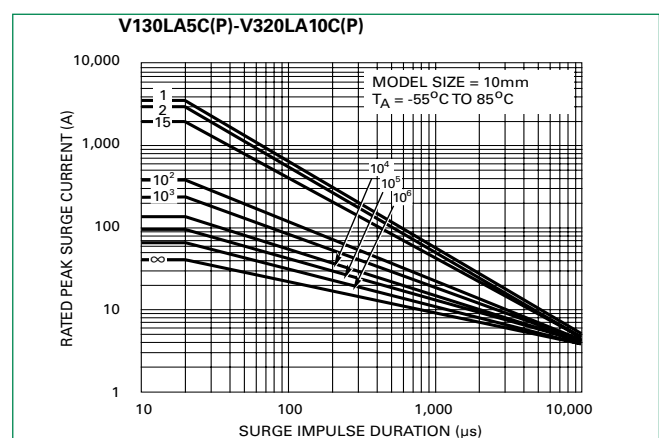
Transient V-I Characteristics Curves

Figure 3. Maximum Clamping Voltage for 10mm Parts



Pulse Rating Curves

Figure 4. Repetitive Surge Capability for 10mm Parts



C-III Series

Radial Leaded Varistors

Transient V-I Characteristics Curves

Figure 5. Maximum Clamping Voltage for 14mm Parts



Pulse Rating Curves

Figure 6. Repetitive Surge Capability for 14mm Parts



Figure 7. Maximum Clamping Voltage for 20mm Parts



Figure 8. Repetitive Surge Capability for 20mm Parts



Note: Repetitive surge capability is qualified and tested based on 8/20μs current waveform (not combination waveform) and UL1449 40.7.3 (Edition 4) test condition.

Figure 9. Maximum Clamping Voltage for Low Clamping Voltage Parts



C-III Series

Radial Leaded Varistors

Wave Solder Profile

Figure 10. Non Lead-free Profile

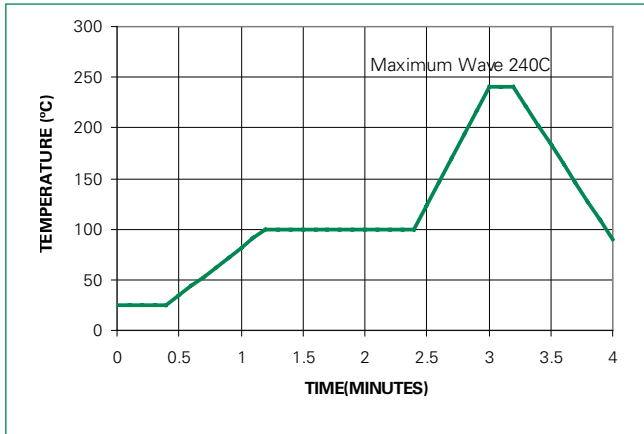


Figure 11. Lead-free Profile



Physical Specifications

| | |
|----------------------------------|---|
| Lead Material | Copper Clad Steel Wire |
| Soldering Characteristics | Solderability per MIL-STD-202, Method 208 |
| Insulating Material | Cured, flame retardant epoxy polymer meets UL94V-0 requirements |
| Device Labeling | Marked with LF, voltage, UL/CSA Logos, and date code |

Environmental Specifications

| | |
|--------------------------------------|--|
| Operating/Storage Temperature | -55°C to +85°C/-55°C to +125°C |
| Humidity Aging | +85°C, 85% RH, 1000 hours +/-10% typical voltage change |
| Thermal Shock | +85°C to -40°C, 5 times +/-10% typical voltage change |
| Solvent Resistance | MIL-STD-202, Method 215 |
| Moisture Sensitivity | Level 1, J-STD-020 |

C-III Series

Radial Leaded Varistors

AC Bias Reliability

The C-III Series MOVs were designed for use on the AC line. The varistor is connected across the AC line and is biased with a constant amplitude sinusoidal voltage. It should be noted that the definition of failure is a shift in the nominal varistor voltage (VN) exceeding +/-10%. Although this type of varistor is still functioning normally after this magnitude of shift, devices at the lower extremities of VN tolerance will begin to dissipate more power. Because of this possibility, an extensive series of statistically designed tests were performed to determine the reliability of the C-III type of varistor under AC bias combined with high levels of temperature stress. To date, this test has generated over 50,000 device hours of operation at a temperature of 125°C, although only rated at 85°C. Changes in the nominal varistor voltage, measured at 1mA, of less than 2% have been recorded, as displayed in the diagram at right.

Figure 12. High Temperature Operating Life 125°C for 1000 Hours at Rated Bias

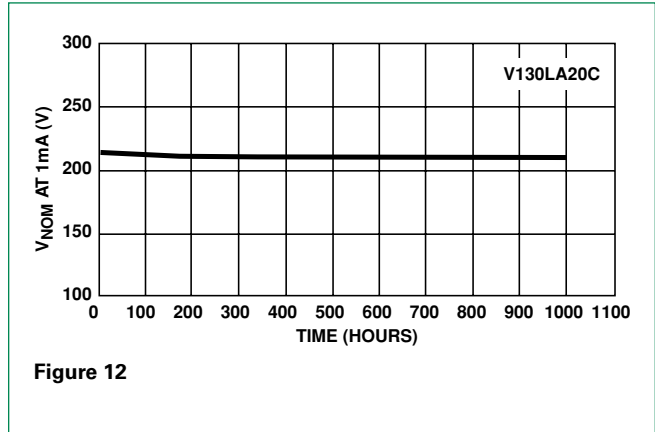


Figure 12

Transient Surge Current/Energy Transient Capability

The transient surge rating serves as an excellent figure of merit for the C-III varistor. This inherent surge handling capability is one of the C-III varistor's best features. The enhanced surge absorption capability results from improved process uniformity and enhanced construction. The homogeneity of the raw material powder and improved control over the sintering and assembly processes are contributing factors to this improvement.

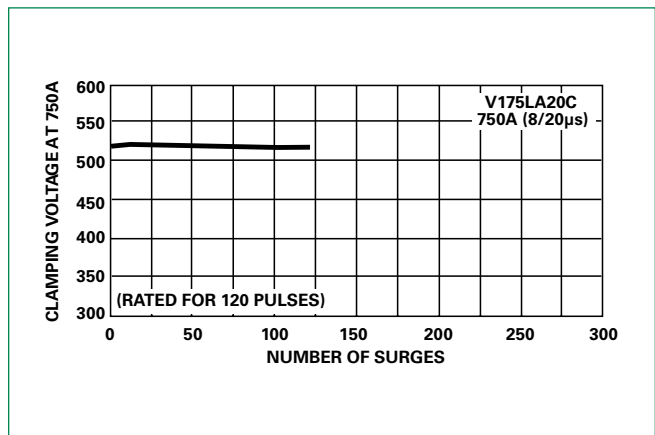
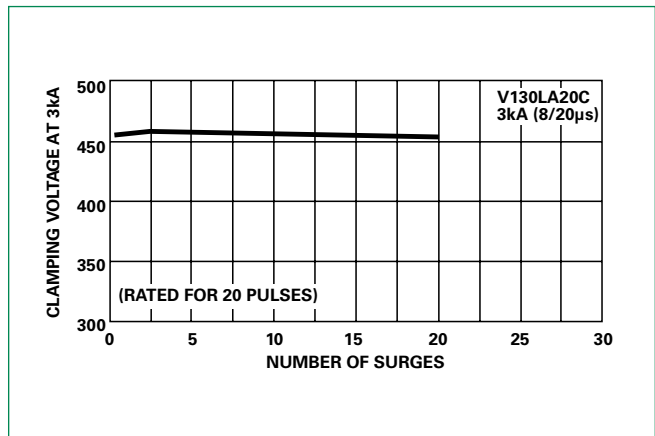
In the low power AC mains environment, industry standards (UL, IEC, NEMA and IEEE) all suggest that the worst case surge occurrence will be 3kA. Such a transient event may occur up to five times over the equipment life time (approximately 10 years). While the occurrences of five 3kA transients is the required capability, the rated, repetitive surge current for the C-III Series is 20 pulses for the 20mm units and 10 pulses for the 14mm Series.

As a measure of the inherent device capability, samples of the 20mm V130LA20C devices were subjected to a worst case repetitive transient surges test. After 20 pulses, each of 3kA, there was negligible change in the device characteristics. Changes in the clamping voltage, measured at 100A, of less than 3% were recorded, as shown in the upper diagram at right.

Samples of the 20mm Series V175LA20C were subjected to repetitive surge occurrences of 750A. Again, there was negligible changes in any of the device characteristics after 120 pulses, as shown in the lower diagram at right.

In both cases the inherent device capability is far in excess of the expected worst case scenario.

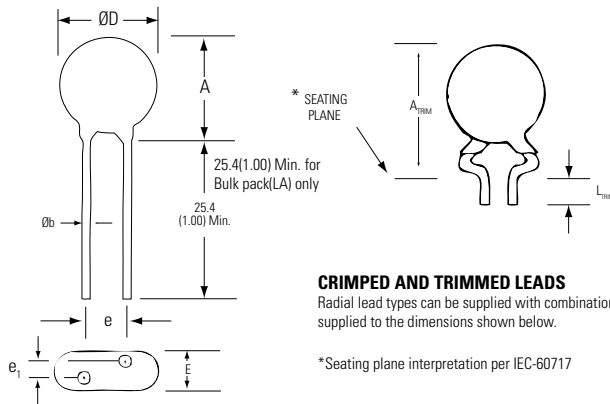
Figure 13 & 14. Typical Repetitive Surge Current Capability of C-III Series MOVs



C-III Series

Radial Ledged Varistors

Product Dimensions (mm)



| Dimension | V _{RMS} Voltage Model | 10mm Size | | 14mm Size | | 20mm Size | |
|-------------------------|--------------------------------|--------------|--------------|--------------|--------------|--------------|--------------|
| | | Min. | Max. | Min. | Max. | Min. | Max. |
| A | All | 12.0 (0.472) | 16.0 (0.630) | 13.5 (0.531) | 20.0 (0.787) | 17.5 (0.689) | 28.0 (1.102) |
| ØD | All | 10.0 (0.394) | 12.5 (0.492) | 13.5 (0.531) | 17.0 (0.669) | 17.5 (0.689) | 23.0 (0.906) |
| e | All | 6.5 (0.256) | 8.5 (0.335) | 6.5 (0.256) | 8.5 (0.335) | 6.5 (0.256) | 8.5 (0.335) |
| e₁ | 130 - 320 | 1.5 (0.059) | 5.5 (0.216) | 1.5 (0.059) | 4.5 (0.177) | 1.5 (0.059) | 4.5 (0.177) |
| | 385 - 680 | 2.5 (0.098) | 7.5 (0.295) | 2.5 (0.098) | 7.5 (0.295) | 2.5 (0.098) | 7.5 (0.295) |
| | > 680 | 4.5 (0.177) | 9.5 (0.374) | 4.5 (0.177) | 9.5 (0.374) | 4.5 (0.177) | 9.5 (0.374) |
| E | 130 - 320 | - | 7.3 (0.287) | - | 7.3 (0.287) | - | 7.3 (0.287) |
| | 385 - 680 | - | 11.0 (0.433) | - | 11.0 (0.433) | - | 11.0 (0.433) |
| | > 680 | - | 14.0 (0.551) | - | 14.0 (0.551) | - | 14.0 (0.551) |
| Øb | 130 - 625 | 0.76 (0.030) | 0.86 (0.034) | 0.76 (0.030) | 0.86 (0.034) | 0.76 (0.030) | 0.86 (0.034) |
| | >625 | - | - | - | - | 0.95 (0.037) | 1.05 (0.041) |
| A_{TRIM} | All | - | 19.5 (0.768) | - | 23.5 (0.925) | - | 30.0 (1.18) |
| L_{TRIM} | All | 2.41 (0.095) | 4.69 (0.185) | 2.41 (0.095) | 4.69 (0.185) | 2.41 (0.095) | 4.69 (0.185) |

Dimensions are in millimeters (inches)

- 10mm lead spacing also available. See additional lead style options.
- 7mm and 12mm devices also available upon request. Contact factory for details.
- 1000V parts supplied with lead wire of diameter 1.00 +/- 0.05 (0.039 +/- 0.002).

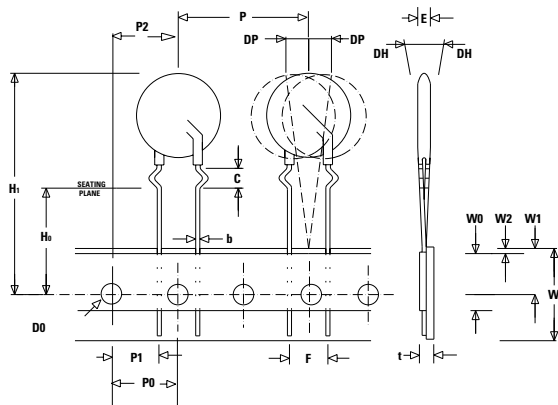
C-III Series

Radial Leaded Varistors

Tape and Reel Specifications

- (available for voltage ratings up to 550V only)

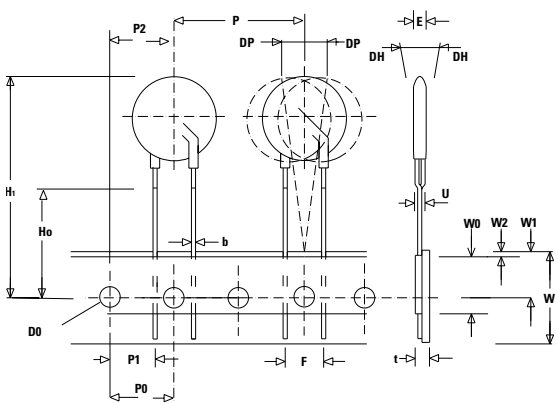
CRIMPED LEADS "LT"



STRAIGHT LEADS "LS"



UNDER-CRIMPED LEADS "LU"

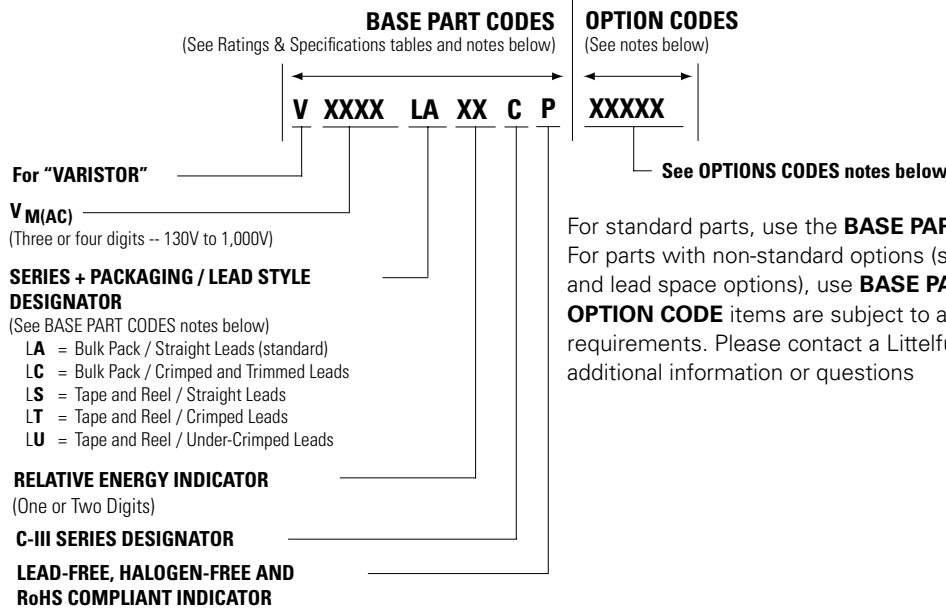


| Symbol | Description | Model Size | | |
|----------------|---|-----------------|--------|----------|
| | | 10mm | 14mm | 20mm |
| P | Pitch of Component | 25.4 +/-1.0 | | |
| P ₀ | Feed Hole Pitch | 12.7 +/- 0.2 | | |
| P ₁ | Feed Hole Center to Pitch | 8.85 +/- 0.8 | | |
| P ₂ | Hole Center to Component Center | 12.7 +/- 0.7 | | |
| F | Lead to Lead Distance | 7.50 +/- 0.8 | | |
| h | Component Alignment | 2.00 Max | | |
| W | Tape Width | 18.25 +/- 0.75 | | |
| W ₀ | Hold Down Tape Width | 12.0 +/- 0.3 | | |
| W ₁ | Hole Position | 9.125 +/- 0.625 | | |
| W ₂ | Hold Down Tape Position | 0.5 Max | | |
| H | Height From Tape Center To Component Base | 19.0 +/-1.0 | | |
| H ₀ | Seating Plane Height | 16.0 +/- 0.5 | | |
| H ₁ | Component Height | 36 Max | 40 Max | 46.5 Max |
| D ₀ | Feed Hole Diameter | 4.0 +/- 0.2 | | |
| t | Total Tape Thickness | 0.7 +/- 0.2 | | |
| p | Component Alignment | 3° Max | | |
| U | Under crimp Width | 8.0 Max | | |

C-III Series

Radial Leaded Varistors

Part Numbering System



Ordering Notes:

BASE PART CODES:

Series + Packaging / Lead Style Designators:

Ordering examples:

| Straight Lead Bulk Pack (standard) | Straight Lead Tape & Reel | Crimped & Trimmed Lead Bulk Pack | Under-Crimp Lead Tape & Reel |
|------------------------------------|---------------------------|----------------------------------|------------------------------|
| V130LA20CP | V130LS20CP | V130LC20CP | V130LU20CP |

Crimped leads are standard on LA Series varistors supplied in tape and reel, denoted with "LT."

"LC" style is supplied in bulk only.

"LU" style is supplied in tape & reel only.

For crimped leads without trimming and any variations other than that described above, please contact Littelfuse.

Packaging and Quantities:

Littelfuse C-III Series varistors are shipped standard in bulk pack with straight leads and lead spacing outlined in the Package Dimensions section of this data sheet.

Tape & Reel Quantities:

| Device Size | Voltage | Quantity Per Reel | | |
|-------------|---------|-------------------|----------|----------|
| | | "T" Reel | "S" Reel | "U" Reel |
| 10mm | ALL | 500 | 500 | 500 |
| 14mm | ≤ 275V | 500 | 500 | 500 |
| | ≥ 275V | 400 | 400 | 400 |
| 20mm | ≤ 275V | 500 | 500 | 500 |
| | ≥ 275V | 400 | 400 | 400 |

OPTION CODES:

X10: 10MM LEAD SPACING OPTION --

For 10 (-/+1)mm lead spacing (available on 20mm diameter models only), append standard model BASE PART number with "X10."

Example:

| Standard Model | Order As |
|----------------|---------------|
| V130LA20CP | V130LA20CPX10 |

X2855: Nickel Barrier COATED WIRE OPTION --

All standard parts use tinned copper clad steel wire. Nickel Barrier Coated wire is available as an option, consisting of Copper wire with a flashing of Nickel followed by a top coating of Tin. To order append standard model BASE PART number with "X2855."

Example:

| Standard Model | Order As |
|----------------|-----------------|
| V130LA20CP | V130LA20CPX2855 |

X1347: Hi-Temperature phenolic coating option --

Phenolic Coated C-III Series devices are available with improved maximum operating maximum temperature of 125°C.

To order, add X1347 to end of part number

(Example: V230LA40CPX1347).

For additional information please refer to the section labeled "Phenolic Coating Option" on the third page of this document under the "Electrical Characteristics" table.

Disclaimer Notice - Information furnished is believed to be accurate and reliable. However, users should independently evaluate the suitability of and test each product selected for their own applications. Littelfuse products are not designed for, and may not be used in, all applications. Read complete Disclaimer Notice at www.littelfuse.com/disclaimer-electronics.

X-ON Electronics

Largest Supplier of Electrical and Electronic Components

Click to view similar products for [Varistors](#) category:

Click to view products by [Littelfuse](#) manufacturer:

Other Similar products are found below :

[820443211E](#) [MLV0603E30403T](#) [MOV05131AIA](#) [MOV07231AQA](#) [MOV18131CZA](#) [R71ZOV151HC](#) [D58ZOV500RA01T1](#)
[B72214S251K151](#) [B72260B102K1](#) [B72280B271K1](#) [B72500E8250L60](#) [B72530E1140S272](#) [B72540E250K62](#) [B72650M0151K093](#)
[B72660M0271K093](#) [NTE1V020](#) [NTE1V130](#) [NTE2V010](#) [NTE2V130](#) [ROV20-220M-S](#) [ROV20H201K](#) [25FN511K](#) [S10K11G5S5](#) [ERZ-](#)
[C07DK221U](#) [ERZ-C14DK361U](#) [ERZ-C20DK221U](#) [207869-1](#) [TMOV25SP625E](#) [TND10V-471KB00AAA0](#) [B72210S271K111](#)
[B72280B112K1](#) [B72280B381K1](#) [B72540E 350K 62](#) [B72590D360A60](#) [B72670M1140K72](#) [MOV07251ARA](#) [MOV10131EDA](#)
[MOV10151EFA](#) [MOV14151CWA](#) [MOV20251DFA](#) [TVZ18EC271KBS](#) [TVZ20EB911KBS](#) [TVZ25D201KBS](#) [TVZ25D241KBS](#)
[VZ07D220KBS](#) [VZ1206M300AGT](#) [Z420LA20A](#) [ROV20H220M-S](#) [VZ40D241KQ-N](#) [VZ40D241K](#)