

厚膜贴片电阻承认书-CR 系列

Approval Specification for Thick Film Chip Resistors - Type **CR**

1. 范围 (scope) :

1.1 适用于本公司所生产的无铅、无卤之厚膜贴片电阻 CR 系列

This specification applies to thick film chip resistors which meet requirements of Pb free and halogen free.

1.2 本公司的无铅产品指的贴片电阻端电极无铅，而存在于电阻层的玻璃中的符合 RoHS 豁免条款。

There no lead exists in terminal of resistor, and lead which exist in glass of resistor layer meets RoHS exemption.

2. 产品料号 (part number) :

0603 1/10W 5% 100 Ω

CR0603JA0101G





<u>CR</u>	<u>0603</u>	<u>J</u>	<u>A</u>	<u>0101</u>	<u>G</u>
↓	↓	↓	↓	↓	↓
类型(Type) CR: 厚膜贴片 电阻(thick film chip resistors)	尺寸(Size) 1005 0201 0402 0603 0805 1206 1210 1812 2010 2512	公差 Tolerance B=±0.1% D=±0.5% F=±1% G=±2% J=±5% K=±10%	额定功率 Rated Power 1= 1W 2= 3/4W 3= 1/2W 4= 1/4W 8= 1/8W A= 1/10W B= 2W F= 1/16W H=1/20W L=1/32W	阻值 Resistance value ±1% , ±0.5% : 49R9=49.9 Ω 1002=10K Ω ±2% , ±5% : 06R8=6.8 Ω 0564=560K Ω	包装代码 Packing Code G=7 inch reel 卷装 正常包装 S=10 inch reel 卷装 加倍数量包装 U=13 inch reel 卷装 再加倍数量包装 V= bulk (散料) * 包装数量见10.2包 装尺寸及数量

备注：1005：为尺寸 01005 规格

厚膜贴片电阻承认书-CR 系列

Approval Specification for Thick Film Chip Resistors - Type **CR**

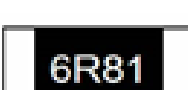
3. 电阻本体字码标示(Marking on the Resistor's Body):

<p>※ 01005、0201 及 0402 因本体太小，本体上无字码标示 For 01005、0201 and 0402 size, no marking on the body due to the small size of the resistor</p>		$472=47 \times 10^2=4.7K \Omega$
<p>※ 公差±2%、±5%的产品，以三字码标示，前两位表示阻值的有效数字，最后一位表示 10 的乘幂 2%、±5% tolerance product: the marking is 3 digits, the first 2 digits are significant figures of resistance value and the 3rd one denotes the power number of 10, (10^x)</p>		10Ω 以下标示：5R6=5.6 Ω Below 10 Ω : 5R6=5.6 Ω
<p>※ 公差±0.1%、±0.5%及±1%的产品，以四字码标示，前三位表示阻值的有效数字，最后一位表示 10 的乘幂 ±0.1%、±0.5% and ±1% tolerance product: the marking is 4 digits, the first 3 digits are significant figures of resistance value and the 4th one denotes the power number of 10, (10^x)</p>		$4992=499 \times 10^2=49.9K \Omega$
<p>※ 0603 ±1% E96 系列的标准阻值，因电阻本体太小，采用三位代码标示。 Standard E96 series values of 0603 ±1%: due to the small size of the resistor's body, use 3digits code to indicate the resistance value.</p>		100Ω 以下标示：6R81=6.81 Ω Below 100 Ω : 6R81=6.81 Ω
<p>※ 0 欧姆产品，采用 000 三位代码标示。 0 Ω Products, use 000 3digits code to indicate the resistance value.</p>		$000=0 \Omega$

厚膜贴片电阻承认书-CR 系列

Approval Specification for Thick Film Chip Resistors - Type **CR**

0603 ±1% E96 系列的标准阻值代码(Standard E96 Series Resistance Value Code for 0603 ±1% Marking)

代码 Code	阻值 Value	代码 Code	阻值 Value	代码 Code	阻值 Value	代码 Code	阻值 Value	代码 Code	阻值 Value	代码 Code	阻值 Value
01	100	17	147	33	215	49	316	65	464	81	681
02	102	18	150	34	221	50	324	66	475	82	698
03	105	19	154	35	226	51	332	67	487	83	715
04	107	20	158	36	232	52	340	68	499	84	732
05	110	21	162	37	237	53	348	69	511	85	750
06	113	22	165	38	243	54	357	70	523	86	768
07	115	23	169	39	249	55	365	71	536	87	787
08	118	24	174	40	255	56	374	72	549	88	806
09	121	25	178	41	261	57	383	73	562	89	825
10	124	26	182	42	267	58	392	74	576	90	845
11	127	27	187	43	274	59	402	75	590	91	866
12	130	28	191	44	280	60	412	76	604	92	887
13	133	29	196	45	287	61	422	77	619	93	909
14	137	30	200	46	294	62	432	78	634	94	931
15	140	31	205	47	301	63	442	79	649	95	953
16	143	32	210	48	309	64	453	80	665	96	976

0603 ±1% E96 系列的指数代码(Multiplier Code for 0603 ±1% Marking)

代码 Code	Y	X	A	B	C	D	E	F
指数 Multiplier	10^{-2}	10^{-1}	10^0	10^1	10^2	10^3	10^4	10^5

阻值标示如下(So the resistance value are marked as the following examples)



$$10D=124 \times 10^3=124K \Omega$$



$$38Y=243 \times 10^{-2}=2.43 \Omega$$

0603 ±1%的产品，在标准 E24 系列中，但不属于 E96 系列，标示与 5%的字码相同，但是在字码下加一条线
 Standard E24 and not belong to E96 series values of 0603 ±1%, the marking is the same as 5% tolerance but marking as underline



$$\underline{331}=33 \times 10^1=330 \Omega$$



$$\underline{560}=56 \times 10^0=56 \Omega$$

厚膜贴片电阻承认书-CR 系列

Approval Specification for Thick Film Chip Resistors - Type **CR**

4. 尺寸 (dimension) :

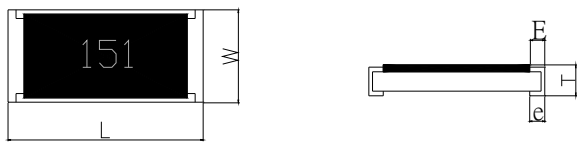
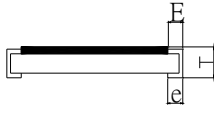
尺寸 dimension					
	单位 (unit) : mm				
型别 (Type)	L	W	T	E	e
CR1005	0.40±0.02	0.20±0.02	0.13±0.02	0.10±0.03	0.10±0.03
CR0201	0.60±0.03	0.30±0.03	0.23±0.03	0.10±0.05	0.15±0.05
CR0402	1.00±0.05	0.50±0.05	0.30±0.05	0.15±0.10	0.20±0.10
CR0603	1.60±0.10	0.80±0.10	0.45±0.10	0.25±0.20	0.30±0.20
CR0805	2.00±0.15	1.25±0.15	0.50±0.10	0.35±0.20	0.40±0.20
CR1206	3.10±0.15	1.60±0.15	0.55±0.10	0.45±0.25	0.40±0.25
CR1210	3.10±0.15	2.50±0.15	0.55±0.15	0.35±0.25	0.60±0.25
CR1812	4.50±0.20	3.10±0.20	0.55±0.15	0.55±0.20	0.70±0.20
CR2010	5.00±0.20	2.50±0.20	0.55±0.15	0.65±0.25	0.50±0.25
CR2512	6.25±0.20	3.10±0.20	0.55±0.15	0.85±0.25	0.95±0.25

5. 功率衰减曲线 (Derating Curve) :

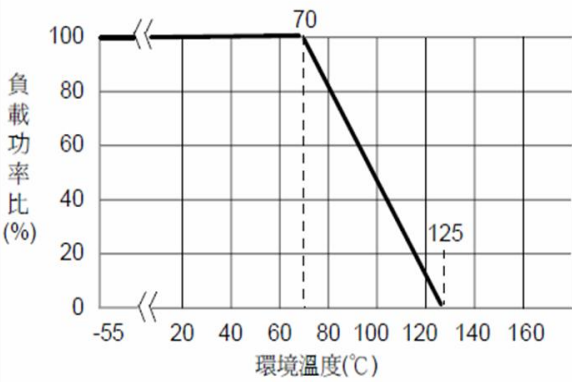
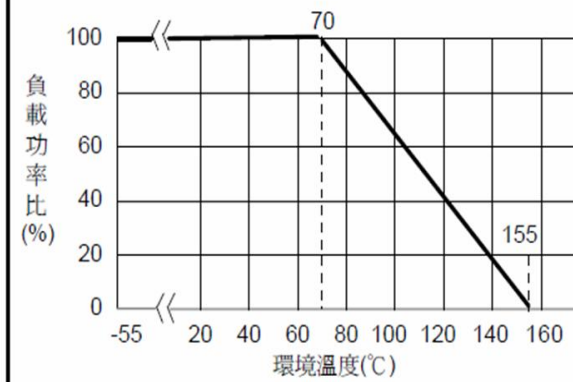
使用 溫度範圍	-55°C ~ +125°C (01005&0201)	-55°C ~ +155°C (其他)
說明	周圍溫度若超過70°C至125°C之間，功率可照 下圖曲線予以修定之。	周圍溫度若超過70°C至155°C之間，功率可照 下圖曲線予以修定之。
功率 衰減 曲線 圖		

工作溫度範圍 (Operating Temperature Range) : -55°C~+125°C (01005&0201 規格);

-55°C~+155°C (其他規格)

儲存條件 (storage condition) : 5~30°C, 30~75%RH.

厚膜贴片电阻承认书-CR 系列

Approval Specification for Thick Film Chip Resistors - Type **CR**

6.电阻结构 (Construction) :

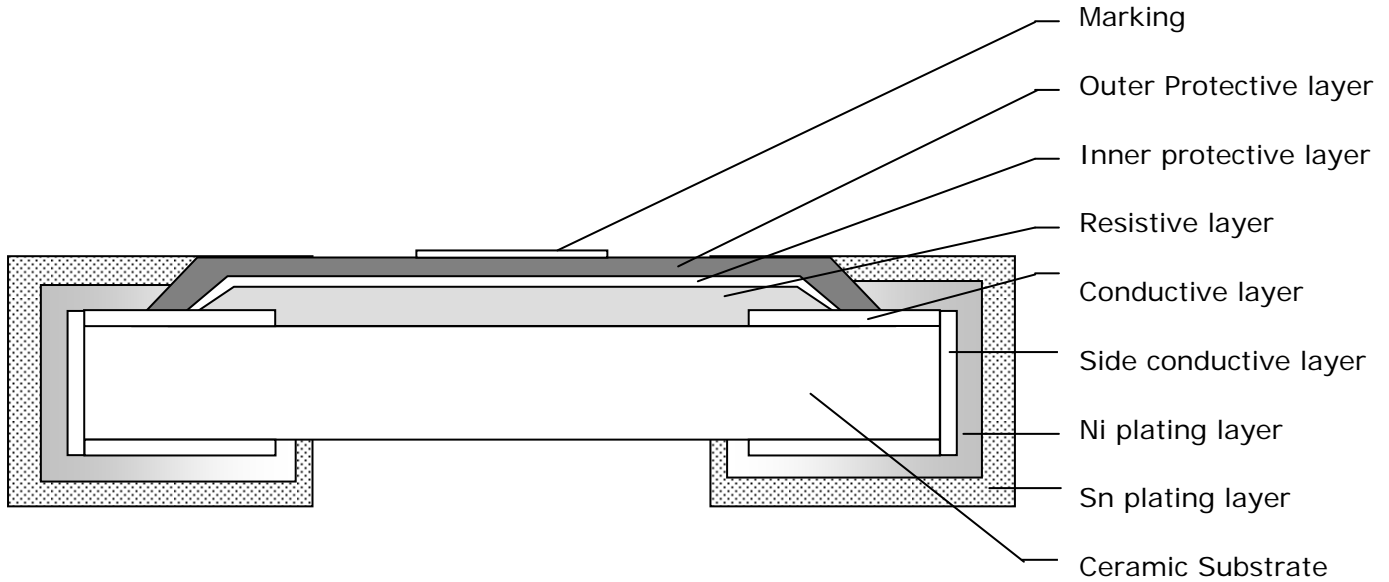

No.	结构 construction	主要材料 Major material
1	陶瓷基板 Ceramic substrate	三氧化二铝 Al ₂ O ₃
2	银电极 Conductive layer	银 Ag
3	侧电极 Side conductive layer	镍铬合金 NiCr
4	阻体层 Resistive layer	氧化钌+玻璃 RuO ₂ + glass
5	内保护层 Inner protective layer	玻璃 Glass
6	外保护层 Outer Protective layer	环氧树脂 Epoxy
7	文字 Marking	环氧树脂 Epoxy
8	镍电极 Ni plating layer	镍 Ni
9	锡电极 Sn plating layer	雾锡 Matte Tin

厚膜贴片电阻承认书-CR 系列

Approval Specification for Thick Film Chip Resistors - Type **CR**

7. 阻值范围 (resistance range) :

型别 Type	阻值范围 Resistance Range			
	0.5%	1%	2%	5%
CR1005	-	1Ω~10MΩ	1Ω~10MΩ	1Ω~10MΩ
CR0201	-	1Ω~10MΩ	1Ω~10MΩ	1Ω~10MΩ
CR0402	10Ω~1MΩ	1Ω~22MΩ	1Ω~22MΩ	1Ω~22MΩ
CR0603	10Ω~1MΩ	1Ω~22MΩ	1Ω~22MΩ	1Ω~100MΩ
CR0805	10Ω~1MΩ	1Ω~22MΩ	1Ω~22MΩ	1Ω~100MΩ
CR1206	10Ω~1MΩ	1Ω~22MΩ	1Ω~22MΩ	1Ω~100MΩ
CR1210	10Ω~1MΩ	1Ω~22MΩ	1Ω~22MΩ	1Ω~100MΩ
CR1812	10Ω~1MΩ	1Ω~10MΩ	1Ω~10MΩ	1Ω~10MΩ
CR2010	10Ω~1MΩ	1Ω~22MΩ	1Ω~22MΩ	1Ω~100MΩ
CR2512	10Ω~1MΩ	1Ω~22MΩ	1Ω~22MΩ	1Ω~100MΩ

8. 电气特性 (electrical characteristics) :

型别 Type	额定功率 Rated power	最大工作电压 Max Working Voltage	最大过负荷电压 Max Overload Voltage	绝缘耐压 Dielectric Withstanding Voltage	零欧姆阻值 Resistance Value of Jumper	零欧姆额定电流 Rated Current of Jumper	零欧姆电阻最大电流 Max Current of Jumper
CR1005	1/32W	15V	30V	30V	<50mΩ	0.5A	1.0A
CR0201	1/20W	25V	50V	75V	<50mΩ	0.5A	1.0A
CR0402	1/16W	50V	100V	150V	<50mΩ	1.0A	2.0A
CR0603	1/10W	75V	150V	220V	<50mΩ	1.0A	2.0A
CR0805	1/8W	150V	300V	430V	<50mΩ	2.0A	5.0A
CR1206	1/4W	200V	400V	570V	<50mΩ	2.0A	10.0A
CR1210	1/2W	200V	500V	710V	<50mΩ	2.0A	10.0A
CR1812	1/2W	200V	500V	710V	<50mΩ	2.0A	10.0A
CR2010	3/4W	200V	500V	710V	<50mΩ	2.0A	10.0A
CR2512	1W	200V	500V	710V	<50mΩ	2.0A	10.0A

备注 (remark) :

※ 额定电压计算公式 (The rated voltage is calculated by the following formula) :

$$E = \sqrt{RP}$$

E : 额定电压 (Rated Voltage) (V)

P : 额定功率 (Rated Power) (W)

R : 电阻阻值 (Resistance) (ohm)

※ 如果计算出的电压超过此型别的最大工作电压,则此型别的最大工作电压为此电阻的额定电压。

In case the value calculated by the formula exceed the maximum working voltage as above table 8, the maximum working voltage shall be regarded as rated voltage.

厚膜贴片电阻承认书-CR 系列

Approval Specification for Thick Film Chip Resistors - Type **CR**

9.性能信赖性测试 (Performance Reliability Test Methods)

内容 Item	测试方法 Test Methods	测试条件 Test Conditions	规格 Specification
温度系数 Temperature Coefficient	JIS C 5201 4.8	$TCR = (R - R_0) / (t - t_0) R_0 \times 10^6$ (ppm) R_0 电阻在室温下的阻值(resistance at room temperature) R 电阻在 125°C 或 -55°C 下的阻值(resistance at 125°C or -55°C) t_0 室温(room temperature) t 测试温度 (test temperature 125°C or -55°C)	01005 规格： $1\Omega \leq R < 10\Omega$ ： -200~+600PPM/°C $10\Omega \leq R \leq 10M\Omega$ ： ±250 PPM/°C 0201 规格： $1\Omega \leq R \leq 10\Omega$ ： -100~+300PPM/°C $10\Omega < R \leq 10M\Omega$ ： ±200 PPM/°C 0402~2512 规格： $1\Omega \leq R \leq 10\Omega$ ： ±200 PPM/°C $10\Omega < R \leq 10M\Omega$ ： ±100 PPM/°C $10M\Omega < R \leq 100M\Omega$ ： ±200PPM/°C
焊锡性 Solderability	JIS C 5201 4.17	沾助焊剂后浸入锡炉，锡炉温度 245±5°C，时间 3±0.5 秒。 Dip the terminal in a flux and then dip into a soldering bath at 245±5°C for 3±0.5sec.	最少 95%面积上锡 (Min 95% coverage)
绝缘电阻 Insulation resistance	JIS C 5201 4.6	电阻本体上加载绝缘耐压 60±5 秒后，测量绝缘阻抗。 Applied the dielectric withstanding voltage on the center of body for 60±5seconds. Then measure insulation resistance.	>10GΩ
绝缘耐压 Dielectric withstanding voltage	JIS C 5201 4.7	电阻本体上加载绝缘耐压 60±5 秒。 Applied the dielectric withstanding voltage on the center of body for 60±5seconds.	无击穿、飞弧及可见 机械性损伤 No evidence of flashover, mechanical damage arcing or insulation breakdown
短时间过负荷 Short-time overload	JIS C 5201 4.13	加载 2.5 倍的额定电压，时间 5 秒后测量试验前后的阻值变化率。 Applied 2.5 times of rated voltage for 5 second. Measure the variation of resistance. $\Delta R\% = \frac{R_2 - R_1}{R_1} * 100 \text{-----} (\%)$ $R_1 = \text{试验前阻值(resistance before test)}$ $R_2 = \text{试验后阻值(resistance after test)}$	±(1.0% +0.05 Ω) Max

厚膜贴片电阻承认书-CR 系列

Approval Specification for Thick Film Chip Resistors - Type **CR**

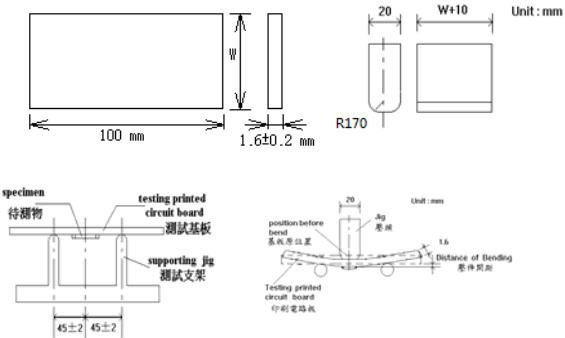
内容 Item	测试方法 Test Methods	测试条件 Test Conditions	规格 Specification
抗焊锡热 Resist to soldering heat	JIS C 5201 4.18	沾助焊剂后浸入锡炉，锡炉温度 $260\pm 5^{\circ}\text{C}$ ，时间 10 ± 0.5 秒，测量试验前后的阻值变化率。 Dip the terminal in a flux and then dip into a soldering bath at $260\pm 5^{\circ}\text{C}$ for $10\pm 0.5\text{sec}$. Measure the variation of resistance. $\Delta R\% = \frac{R_2 - R_1}{R_1} * 100 \text{-----} (\%)$ R1 = 试验前阻值(resistance before test) R2 = 试验后阻值(resistance after test)	$\pm(1.0\%+0.05\ \Omega)$ Max
端子弯曲 Terminal bending	JIS C 5201 4.33	电阻焊接在测试板上进行弯折,弯折保持时间 20 ± 1 秒，1206(含) 以下的尺寸弯曲 $5^{+0.2}/\text{mm}$ ；1206 以上的尺寸弯曲 $2^{+0.2}/\text{mm}$ ；量测试验前后阻值变化率 Specimen shall be mounted on test board, then bend the board and maintained for $20\pm 1\text{s}$. the distance of bending is $5^{+0.2}/\text{mm}$ for resistors which size no larger than 1206 or $2^{+0.2}/\text{mm}$ which size larger than 1206. Measure the variation of resistance. 测试板 (test board) 压头 (jig) <div style="text-align: center;">  </div> $\Delta R\% = \frac{R_2 - R_1}{R_1} * 100 \text{-----} (\%)$ R1 = 试验前阻值(resistance before test) R2 = 试验后阻值(resistance after test)	$\pm(1.0\%+0.05\ \Omega)$ Max

厚膜贴片电阻承认书-CR 系列

Approval Specification for Thick Film Chip Resistors - Type **CR**

内容 Item	测试方法 Test Methods	测试条件 Test Conditions	规格 Specification
温度循环 Temperature Cycling	JIS C 5201 4.19	电阻放入温度循环机中，温度 155±2℃ 至 -55±3℃，共 5 个循环。 量测试验前后阻值变化率。 Put specimen in a chamber which temperature can be changed to 155±2℃ or -55±3℃, repeated 5 times. Measure the variation of resistance. $\Delta R\% = \frac{R_2 - R_1}{R_1} * 100 \text{-----} (\%)$ R1 = 试验前阻值(resistance before test) R2 = 试验后阻值(resistance after test)	±(2.0%+0.05 Ω) Max
耐湿特性 Humidity	JIS C 5201 4.24	电阻放入恒温恒湿箱，温度 40±2℃，湿度 90~95 %RH;通电额定电压 1.5 小时，断电 0.5 小时;重复通断电至试验时间 1000 ⁺⁴⁸ /0 小时。量测试验前后阻值变化率。 Put the specimen in a chamber at 40±2℃ temperature and 90~95% relative humidity, then applied rated voltage for 1.5H and rested for 0.5H repeatedly till total test time is 1000 ⁺⁴⁸ /0.. Measure the variation of resistance. $\Delta R\% = \frac{R_2 - R_1}{R_1} * 100 \text{-----} (\%)$ R1 = 试验前阻值(resistance before test) R2 = 试验后阻值(resistance after test)	±(2.0%+0.05 Ω) Max
负荷寿命 Load life	JIS C 5201 4.25.1	电阻放入恒温箱中，温度 70±2℃，ON TIME:1.5H，OFF TIME:0.5H，通电额定电压 1000 ⁺²⁴ /0 小时，量测试验前后阻值变化率。 Put the specimen in a chamber at 70±2℃ temperature, ON TIME:1.5H OFF TIME:0.5H，and applied rated voltage for 1000 ⁺²⁴ /0H. Measure the variation of resistance. $\Delta R\% = \frac{R_2 - R_1}{R_1} * 100 \text{-----} (\%)$ R1 = 试验前阻值(resistance before test) R2 = 试验后阻值(resistance after test)	CR01005 规格: ±(5.0%+0.05 Ω) Max CR0201~CR2512 规格: ±(2.0%+0.05 Ω) Max

厚膜贴片电阻承认书-CR 系列

Approval Specification for Thick Film Chip Resistors - Type **CR**

内容 Item	测试方法 Test Methods	测试条件 Test Conditions	规格 Specification
温湿循环 Moisture resistance	MIL-STD-202 METHOD 106	25 ° C~65 ° C,90~100%RH, 2.5 小时 ; 65 ° C 90~100%RH, 3小时; 65°C~25°C,80~100%RH,2.5小 时,10个循环,试验结束24±4小时后进行测试. 25°C~65°C,90~100%RH, 2.5H; 65°C 90~100%RH, 3H; 65°C~25°C 80~100%RH, 2.5H, 10 cycles, Measurement at 24±4 hours after test conclusion. $\Delta R\% = \frac{R_2 - R_1}{R_1} * 100 \text{-----} (\%)$ R1 = 试验前阻值(resistance before test) R2 = 试验后阻值(resistance after test)	±(2.0% +0.05Ω) Max

10. 包装规格 (Tapping Specification)

10.1 卷盘尺寸 (reel dimension)

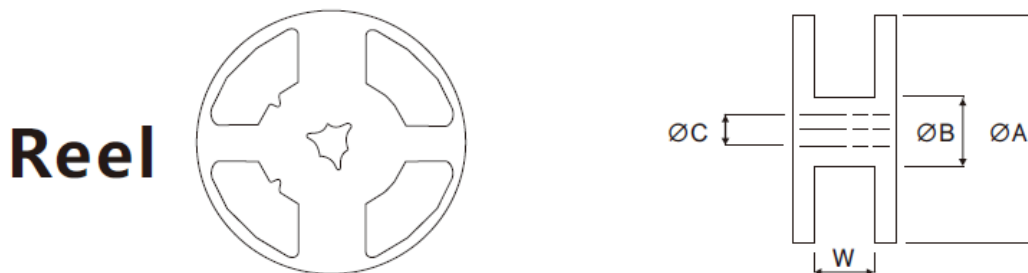

Unit: mm

卷盘及纸带 Reel Type / Tape	Φ A	Φ B	Φ C	W
7" reel for 8 mm tape	178±2.0	60.0±1.0	13.5±0.5	9.00±0.3
7" reel for 12 mm tape	178±2.0	60.0±1.0	13.5±0.5	13.0±0.3
10" reel for 8 mm tape	254±1.0	100.0±1.0	13.5±0.5	10.0±1.0
13" reel for 8 mm tape	330±1.0	100.0±1.0	13.5±0.5	10.0±0.5

厚膜贴片电阻承认书-CR 系列

Approval Specification for Thick Film Chip Resistors - Type **CR**

10.2 包装尺寸及数量 (Packing Style And Packaging Quantity)

Unit: pcs/reel

Product Size	7 inch reel	10 inch reel	13 inch reel
CR1005	20,000	---	80,000
CR0201	10,000	20,000	50,000
CR0402	10,000 / 20,000	20,000	50,000
CR0603	5,000	10,000	20,000
CR0805	5,000	10,000	20,000
CR1206	5,000	10,000	20,000
CR1210	5,000	10,000	20,000
CR1812	4,000	---	---
CR2010	4,000	---	---
CR2512	4,000	---	---

10.3 包装尺寸 (Packing Dimension)

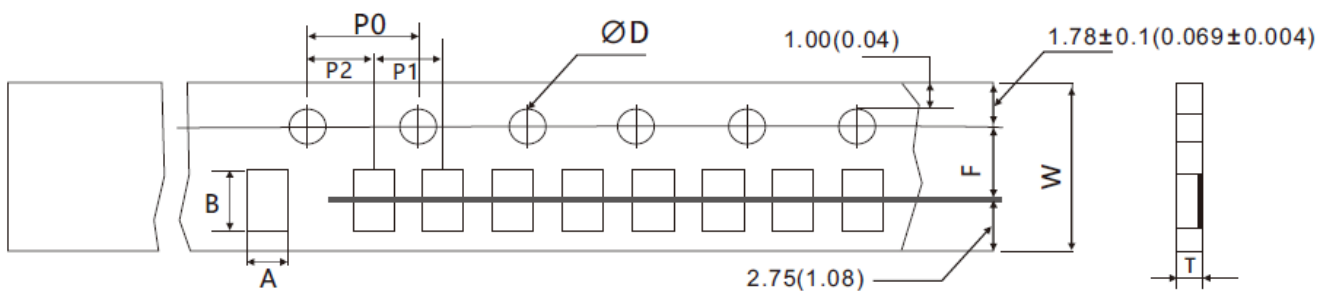

Unit: mm



Dimensions	A	B	D	F	P0	P1	P2	W	T
CR1005	0.24±0.05	0.45±0.05	1.50± $\begin{smallmatrix} 0.1 \\ 0.0 \end{smallmatrix}$	3.50±0.05	4.00±0.10	2.00±0.10	2.00±0.05	8.00±0.20	0.40±0.07
CR0201	0.38±0.05	0.68±0.05	1.50± $\begin{smallmatrix} 0.1 \\ 0.0 \end{smallmatrix}$	3.50±0.05	4.00±0.10	2.00±0.10	2.00±0.05	8.00±0.20	0.42±0.07
CR0402	0.65±0.10	1.15±0.10	1.50± $\begin{smallmatrix} 0.1 \\ 0.0 \end{smallmatrix}$	3.50±0.05	4.00±0.10	2.00±0.10	2.00±0.05	8.00±0.20	0.42±0.07
CR0603	1.10±0.10	1.90±0.10	1.50± $\begin{smallmatrix} 0.1 \\ 0.0 \end{smallmatrix}$	3.50±0.05	4.00±0.10	4.00±0.10	2.00±0.05	8.00±0.20	0.60±0.07
CR0805	1.65±0.20	2.40±0.20	1.50± $\begin{smallmatrix} 0.1 \\ 0.0 \end{smallmatrix}$	3.50±0.05	4.00±0.10	4.00±0.10	2.00±0.05	8.00±0.20	0.75±0.07
CR1206	2.00±0.20	3.60±0.20	1.50± $\begin{smallmatrix} 0.1 \\ 0.0 \end{smallmatrix}$	3.50±0.05	4.00±0.10	4.00±0.10	2.00±0.05	8.00±0.20	0.75±0.07
CR1210	2.80±0.20	3.50±0.20	1.50± $\begin{smallmatrix} 0.1 \\ 0.0 \end{smallmatrix}$	3.50±0.05	4.00±0.10	4.00±0.10	2.00±0.05	8.00±0.20	0.75±0.07
CR1812	3.30±0.20	4.60±0.20	1.50± $\begin{smallmatrix} 0.1 \\ 0.0 \end{smallmatrix}$	5.50±0.05	4.00±0.10	4.00±0.10	2.00±0.05	12.0±0.10	1.0±0.07
CR2010	2.90±0.10	5.30±0.10	1.50± $\begin{smallmatrix} 0.1 \\ 0.0 \end{smallmatrix}$	5.50±0.05	4.00±0.10	4.00±0.10	2.00±0.05	12.0±0.10	1.0±0.07
CR2512	3.40±0.10	6.60±0.10	1.50± $\begin{smallmatrix} 0.1 \\ 0.0 \end{smallmatrix}$	5.50±0.05	4.00±0.10	4.00±0.10	2.00±0.05	12.0±0.10	1.0±0.07

11. 上胶带剥离力测试 (Peel force of top cover tape)

上胶带以 200mm/分钟的速度，沿 165~180 度角的方向进行剥离，如下图所示。纸带的剥离力范围为 10g~70g；载带的剥离力范围为 15~80g。

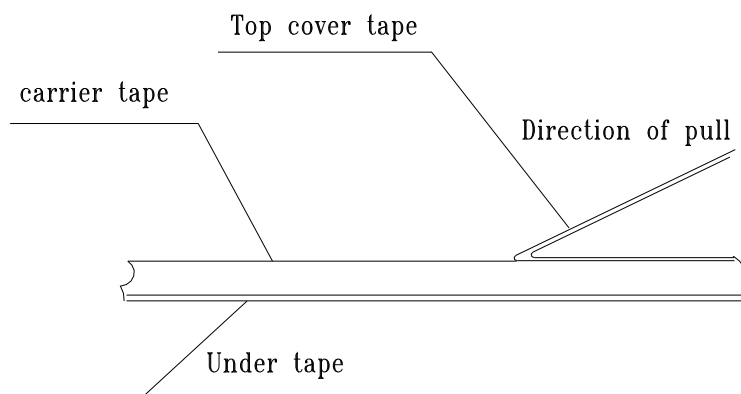
The top cover tape is pulled at a speed of 200 mm/min with the angle between the tape during peel and the direction of unreeling maintained at 165 to 180 degree as following picture. The peel force of paper carrier tape shall be 0.1N to 0.7N(10 to 70 g), the peel force of plastic carrier tape shall be 0.15N to 0.80N (15 to 80 g)

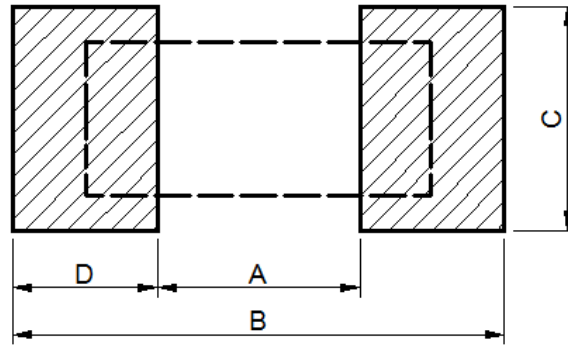

Approval Specification for Thick Film Chip Resistors - Type CR
12. 焊盘尺寸 (Recommended land patterns):

 **Product**
 **Welding Plate**

Type	Land pattern	Dimensions (mm)			
		A	B	C	D
	CR1005	0.15~0.20	0.50~0.70	0.20~0.25	0.18~0.23
	CR0201	0.25~0.30	0.70~0.90	0.30~0.40	0.23~0.28
	CR0402	0.50~0.60	1.40~1.60	0.40~0.60	0.42~0.52
	CR0603	0.70~0.90	2.00~2.20	0.80~1.00	0.60~0.70
	CR0805	1.00~1.40	3.20~3.80	0.90~1.40	1.10~1.20
	CR1206	2.00~2.40	4.40~5.00	1.20~1.80	1.15~1.35
	CR1210	2.00~2.40	4.40~5.00	2.30~3.50	1.15~1.35
	CR1812	3.10~3.30	5.70~5.90	3.20~3.40	1.30~1.50
	CR2010	3.30~3.70	5.70~6.50	2.30~3.50	1.20~1.40
	CR2512	3.60~4.00	7.60~8.60	2.30~3.50	2.05~2.25

13. 焊接 (soldering)
13.1 建议回流焊曲线 (Recommend reflow soldering profile)

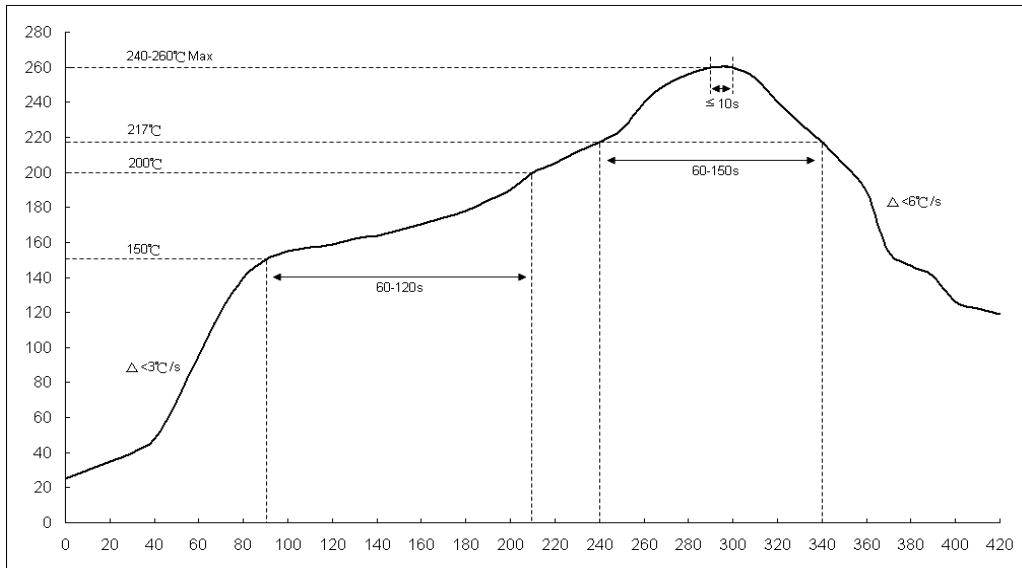
Approval Specification for Thick Film Chip Resistors - Type **CR**



13.2 建议波峰焊曲线 (Recommend wave soldering profile)

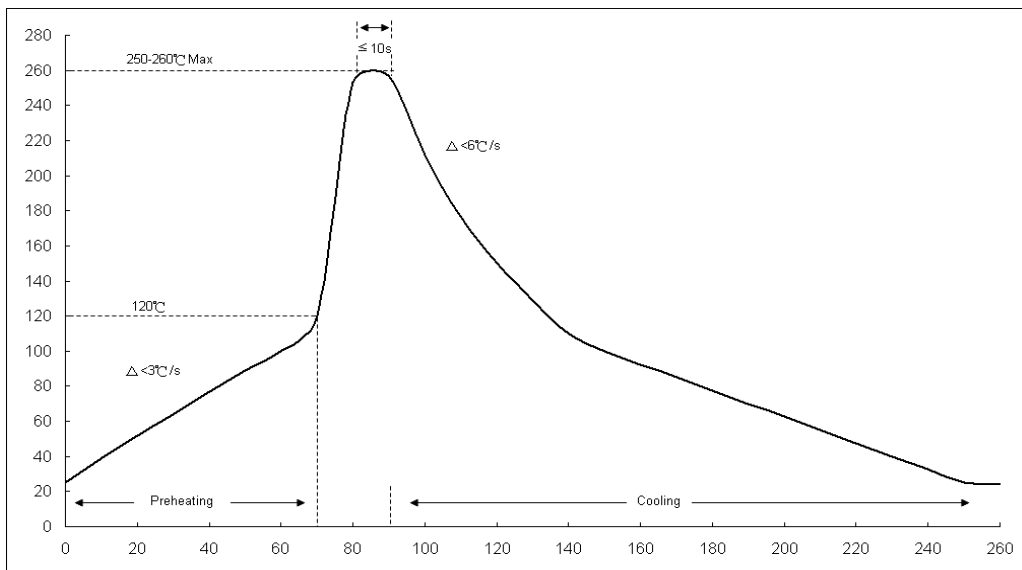

13.3 手工焊温度 (hand soldering temperature)

烙鐵溫度 $350 \pm 10^{\circ}\text{C}$ 3 秒之內，避免烙鐵接觸電阻本體

The iron temperature is $350 \pm 10^{\circ}\text{C}$, hand soldering time less than 3S. Avoid solder iron tip direct touch the components body.

产品规格及资料如有更改，恕不另行通知。

All product specification and data are subject to change without notice

X-ON Electronics

Largest Supplier of Electrical and Electronic Components

Click to view similar products for [Thick Film Resistors - SMD category](#):

Click to view products by [LIZ manufacturer](#):

Other Similar products are found below :

[CR-05FL7--150R](#) [CR-05FL7--698K](#) [CR-12JP4--680R](#) [CRCW04021K20FKEE](#) [CRCW04028R20JNEE](#) [CRCW06032K10FKEC](#)
[CRCW06036K80FKEE](#) [M55342K03B499DRS6](#) [M55342K06B6E19RWL](#) [M55342K09B5D62RS6](#) [M55342M06B26E7RS3](#) [742C083750JTR](#)
[MCR01MZPF1202](#) [MCR01MZPF1601](#) [MCR01MZPF1800](#) [MCR01MZPF6201](#) [MCR01MZPF9102](#) [MCR01MZPJ121](#) [MCR01MZPJ125](#)
[MCR01MZPJ751](#) [MCR03EZHJ103](#) [MCR03EZPFX2004](#) [MCR03EZPJ270](#) [MCR03EZPJ821](#) [MCR10EZPF1102](#) [MCR10EZPF2700](#)
[MCR18EZPJ330](#) [RC1005F1152CS](#) [RC1005F1372CS](#) [RC1005F1912CS](#) [RC1005F2052CS](#) [RC1005F3011CS](#) [RC1005F471CS](#)
[RC1005F4751CS](#) [RC1005F5621CS](#) [RC1005F6041CS](#) [RC1005J121CS](#) [RC1005J122CS](#) [RC1005J154CS](#) [RC1005J180CS](#) [RC1005J181CS](#)
[RC1005J202CS](#) [RC1005J391CS](#) [RC1005J560CS](#) [RC1005J683CS](#) [RC1608F1022CS](#) [RC1608F333CS](#) [RC1608F3651CS](#) [RC1608F5110CS](#)
[RC1608J121CS](#)