



# Approval Specification for Thick Film Chip Resistors - Type **CR**

## 1. Scope

This specification prescribes lead free thick film chip resistors for use in electronics system

## 2. Designation

**Chip Resistor 0805 1/8W ±5% 4K7Ω**

**CR0805J80472G**



Series	Size Code	Tolerance	Power Rating	Value	SPECIAL VALUE
Name	0201	B=± 0.1%	1= 1W	4digitals	G= reel
Product..	0402	C=± 0.25%	2= 1/2W	49R9=49.9	V= bulk
CR=Chip	0603	D=± 0.5%	3= 1/3W	0472=4K7	D= special
Resistor	0805	F=± 1%	4= 1/4W	0103=10K	requirement
	1206	G=± 2%	8= 1/8W	0564=560K	
	1210	J=± 5%	A= 1/10W		
	2010	K=± 10%	F= 1/16W		
	2512		H=1/20W		

### 2.2 Remark:

(1) Common code for chip resistors

(2) Normal resistance value for tolerance ±0.1% , ±0.25%, ±0.5% ±1% :

the first three digits are significant figures of resistance value and the fourth one denotes the power number of 10, (10<sup>X</sup>)

Example: 330 ohm: 3300, 4.7K ohm: 4701

22K ohm: 2202, 100K ohm: 1003

(3) Normal resistance value for tolerance ±2% , ±5%, ±10%:

the first digit is zero, the second and third digit are significant figures of resistance value and the fourth one denotes the power number of 10, (10<sup>X</sup>)

Example: 330 ohm: 0331, 4.7K ohm: 0472

22K ohm: 0223, 100K ohm: 0104

(3) EXPLANATION OF PART NUMBER FOR 0603, ±1%

Approval Specification for Thick Film Chip Resistors - Type **CR**

EIA-96 Marking

code R Value	code R Value	code R Value	code R Value	code R Value	code R Value	code R Value	code R Value
01 100	13 133	25 178	37 237	49 316	61 422	73 562	85 750
02 102	14 137	26 182	38 243	50 324	62 432	74 576	86 768
03 105	15 140	27 187	39 249	51 332	63 442	75 590	87 787
04 107	16 143	28 191	40 255	52 340	64 453	76 604	88 806
05 110	17 147	29 196	41 261	53 348	65 464	77 619	89 825
06 113	18 150	30 200	42 267	54 357	66 475	78 634	90 845
07 115	19 154	31 205	43 274	55 365	67 487	79 649	91 866
08 118	20 158	32 210	44 280	56 374	68 499	80 665	92 887
09 121	21 162	33 215	45 287	57 383	69 511	81 681	93 909
10 124	22 165	34 221	46 294	58 392	70 523	82 698	94 931
11 127	23 169	35 226	47 301	59 402	71 536	83 715	95 953
12 130	24 174	36 223	48 309	60 412	72 549	84 732	96 976

This table shows the first two digits for the three-digit EIA-96 part marking scheme the third character is a letter multiplier:

$Y=10^{-2}$ ,  $X=10^{-1}$ ,  $A=10^0$ ,  $B=10^1$ ,  $C=10^2$ ,  $D=10^3$ ,  $E=10^4$ ,  $F=10^5$

- (4) If the resistance value is not found in the table for 0603 product, will use normal three digits to show the value, but will add a special mark “-” under the three digits. Example as following:

“ 331 ” indicates that it is 0603  $\pm 1\%$  330ohm product.

### 3. Rating

#### 3.1 Rated Power (%)

Rated power shall be load power corresponding to normal wattage suitable for continuous use at 70°C ambient temperature in case the ambient temperature exceeds 70°C reduce the load power in accordance with derating curve shown as

TYPE	Rated Power	Max. Working Voltage	Max. Overload Voltage
CR0201	1/20W	25V	50V
CR0402	1/16W	50V	100V
CR0603	1/10W	50V	100V
CR0805	1/8W	150V	300V
CR1206	1/4W	200V	400V
CR1210	1/3W	200V	400V
CR2010	1/2W	200V	400V
CR2512	1W	200V	400V



### Approval Specification for Thick Film Chip Resistors - Type **CR**

#### 3.2 Derating Curve



#### 3.3 Operating Temperature Range -55°C~+125°C ;

storage condition is 5~30°C, 30~75%RH.

#### 3.4 Rated Voltage

The rated voltage is calculated from the rated power and normal resistance by the following formula:  $E = \sqrt{RP}$

Where : E : Rated Voltage (V)

P : Rated Power (W)

R : Normal Resistance (ohm)

In case the value calculated by the formula exceed the maximum working voltage as 3.1 the maximum working voltage shall be regarded as rated

#### 3.5 Resistance Range and Resistance Tolerance

TYPE NO.	Tolerance (%)	Symbol	Resistance Range(ohm)	Standard Resistance Values
CR0402 CR0603 CR0805 CR1206	±0.5%	D	10~1M	E96
CR0201	±1%	F	1R0~10M	E96
CR0402	±2%	G		
CR0603	±5%	J	1R0~22M (0201:1R0~10M)	E24
CR0805	±10%	K		
CR1206	±20%	M		
CR1210				
CR2010				
CR2512				



### Approval Specification for Thick Film Chip Resistors - Type **CR**

#### 4. Dimension

##### 4.1 Dimension

DIMENSIONS					
	Type	L	W	T	E
CR0201	0.60±0.03	0.30±0.03	0.23±0.03	0.15±0.05	0.15±0.05
CR0402	1.00±0.05	0.50±0.05	0.35±0.05	0.15±0.10	0.20±0.10
CR0603	1.60±0.15	0.80±0.10	0.45±0.10	0.25±0.20	0.30±0.20
CR0805	2.00±0.15	1.25±0.15	0.50±0.10	0.35±0.20	0.40±0.20
CR1206	3.10±0.15	1.60±0.15	0.55±0.10	0.45±0.25	0.40±0.25
CR1210	3.10±0.15	2.50±0.15	0.55±0.15	0.35±0.25	0.60±0.35
CR2010	5.00±0.20	2.50±0.20	0.55±0.15	0.65±0.25	0.50±0.25
CR2512	6.25±0.20	3.10±0.20	0.55±0.15	0.85±0.25	0.95±0.25

##### 4.2. Construction and materials



Approval Specification for Thick Film Chip Resistors - Type **CR**

No.	construction	Major material
1	Ceramic substrate	Al <sub>2</sub> O <sub>3</sub>
2	Conductive layer	Ag
3	Side conductive layer	NiCr
4	Resistive layer	RuO <sub>2</sub> + glass
5	Inner protective layer	Glass
6	Protective layer	Epoxy
7	Marking	Epoxy
8	Termination barrier layer	Ni
9	Termination layer	Matte Tin

## 4.3 Electrical Characteristics:

Type	Rated Power at 70°C	Max. Working Voltage	Max. Overload Voltage	T.C.R (ppm/°C)	Resistance Range				Jumper Resistance Value	Jumper Rated Current
					D(±0.5%) E96	F(±1%) E96	G(±2%) E24	J(±5%) E24		
0201	1/20W	25V	50V	±600	-----	1Ω~25Ω	1Ω~25Ω	1Ω~25Ω	50mΩ MAX	0.5A
				±250	-----	25Ω~10MΩ	25Ω~10MΩ	25Ω~10MΩ		
0402	1/16W	50 V	100V	+500~-250	-----	1Ω~10Ω	1Ω~10Ω	1Ω~10Ω	50mΩ MAX	1A
				±200	-----	10Ω~1MΩ	10Ω~10MΩ	10Ω~22MΩ		
				±100	-----	-----	-----	-----		
0603	1/10W	50V	100V	+500~-250	-----	1Ω~10Ω	1Ω~10Ω	1Ω~10Ω	50mΩ MAX	1A
				±200	-----	-----	10Ω~10MΩ	10Ω~22MΩ		
				±100	-----	10Ω~1MΩ	10Ω~10MΩ	-----		
0805	1/8W	150V	300V	+500~-250	-----	1Ω~10Ω	1Ω~10Ω	1Ω~10Ω	50mΩ MAX	1.5A
				±200	-----	-----	10Ω~10MΩ	10Ω~22MΩ		
				±100	-----	10Ω~1MΩ	10Ω~10MΩ	-----		
1206	1/4W	200V	400V	+500~-250	-----	1Ω~10Ω	1Ω~10Ω	1Ω~10Ω	50mΩ MAX	1.9A
				±200	-----	-----	10Ω~10MΩ	10Ω~22MΩ		
				±100	-----	10Ω~1MΩ	10Ω~10MΩ	-----		
1210	1/3W	200V	400V	+500~-250	-----	1Ω~10Ω	1Ω~10Ω	1Ω~10Ω	50mΩ MAX	2.2A
				±200	-----	-----	10Ω~10MΩ	10Ω~22MΩ		
				±100	-----	10Ω~10MΩ	-----	-----		
2010	1/2W	200V	400V	+500~-250	-----	1Ω~10Ω	1Ω~10Ω	1Ω~10Ω	50mΩ MAX	3A
				±200	-----	-----	10Ω~10MΩ	10Ω~22MΩ		
				±100	-----	10Ω~10MΩ	-----	-----		
2512	1W	200V	400V	+500~-250	-----	1Ω~10Ω	1Ω~10Ω	1Ω~10Ω	50mΩ MAX	3A
				±200	-----	-----	10Ω~10MΩ	10Ω~22MΩ		
				±100	-----	10Ω~10MΩ	-----	-----		

\*ZERO OHM JUMPER&lt;0.050HM

Approval Specification for Thick Film Chip Resistors - Type **CR****5. Environmental performance**

Description	Specification Limits	Test Methods
Temperature Coefficient	(over 10ohm) $\pm 200$ ppm/ $^{\circ}\text{C}$ Max. (lower 10ohm) $+500 \sim -250$ ppm/ $^{\circ}\text{C}$	JIS C5202 5.2
Short Time Overload	$\pm(1.00\%+0.05\text{ohm})$ Max.	JIS C5202 5.5
Resistance to Soldering Heat	$\pm(1.00\%+0.05\text{ohm})$ Max.	JIS C5202 6.4
Solderability	95% Coverage Min.	JIS C5202 6.4
Load Life	$\pm(3.00\%+0.05\text{ohm})$ Max.	JIS C5202 7.10
Load Life Humidity	$\pm(2.00\%+0.05\text{ohm})$ Max.	JIS C5202 7.5
Temperature Cycle	$\pm(2.00\%+0.05\text{ohm})$ Max.	JIS C5202 7.6
Component high temperature resistance	$\pm(1.00\%+0.05\text{ohm})$ Max.	<260 $^{\circ}\text{C}$ 10second 3times
Component rework/hand soldering temperature resistance	Avoid solder iron tip direct touch the components body	Approx. 350 $^{\circ}\text{C}$ for 3seconds
MSL (moisture sensitive level)	Level 1	J-STD-020C

**6. Tapping Specification**

Dimensions		A	B	C	F	W
CR0201	mm	178 $\pm$ 2.0	60.0 $\pm$ 1.0	13.5 $\pm$ 0.5	11.4 $\pm$ 0.1	9.00 $\pm$ 0.3
CR0402						
CR0603	Inch	7.008 $\pm$ 0.079	2.362 $\pm$ 0.039	0.531 $\pm$ 0.020	0.449 $\pm$ 0.039	0.354 $\pm$ 0.012
CR0805						
CR1206						
CR1210						
CR2010	mm	178 $\pm$ 2.0	60.0 $\pm$ 1.0	13.5 $\pm$ 0.5	15.4 $\pm$ 1.0	13.0 $\pm$ 0.3
CR2512	Inch	7.008 $\pm$ 0.079	2.362 $\pm$ 0.039	0.531 $\pm$ 0.020	0.606 $\pm$ 0.039	0.512 $\pm$ 0.012

Remark: (1)CR0201/CR0402 Quantity per Reel 10,000 pcs/Reel

(2)CR2010/CR2512 Quantity per Reel 4,000 pcs/Reel

Reel

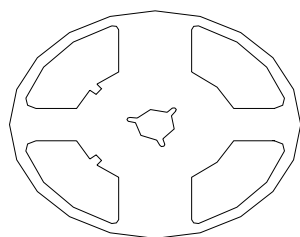
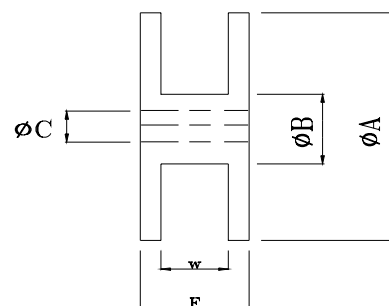
Standard Quantity per Reel  
5,000 pcs/Reel



Approval Specification for Thick Film Chip Resistors - Type **CR**

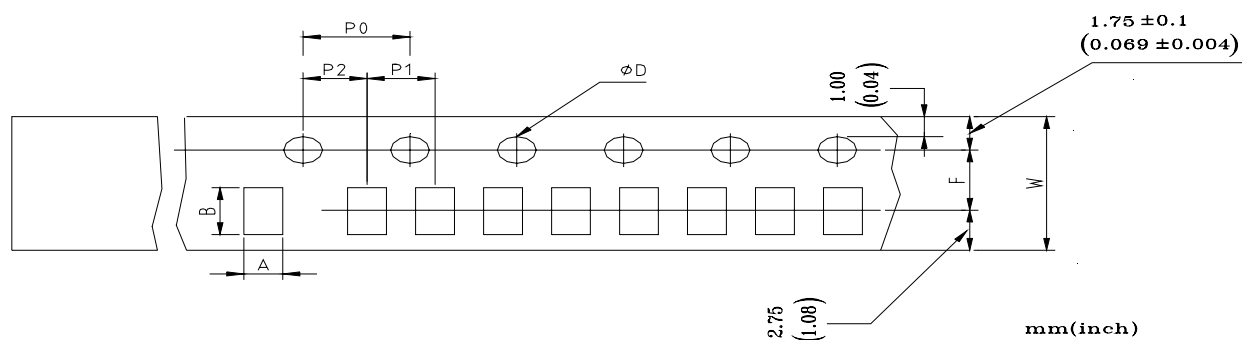

Dimensions		A	B	D	F	P0	P1	P2	W
CR0201	mm	0.38±0.05	0.68±0.05	1.50±0.10	3.50±0.05	4.00±0.10	2.00±0.10	2.00±0.05	8.00±0.20
	inch	0.015 ±0.002	0.027 ±0.002	0.059 ±0.004	0.138 ±0.002	0.157 ±0.004	0.079 ±0.004	0.079 ±0.002	0.315 ±0.008
CR0402	mm	0.65±0.10	1.15±0.10	1.50±0.10	3.50±0.05	4.00±0.10	2.00±0.10	2.00±0.05	8.00±0.20
	inch	0.026 ±0.004	0.045 ±0.004	0.059 ±0.004	0.138 ±0.002	0.157 ±0.004	0.079 ±0.004	0.079 ±0.002	0.315 ±0.008
CR0603	mm	1.10±0.10	1.90±0.10	1.50±0.10	3.50±0.05	4.00±0.10	4.00±0.10	2.00±0.05	8.00±0.20
	inch	0.043 ±0.004	0.075 ±0.004	0.059 ±0.004	0.138 ±0.002	0.157 ±0.004	0.157 ±0.004	0.079 ±0.002	0.315 ±0.008
CR0805	mm	1.65±0.20	2.40±0.20	1.50±0.10	3.50±0.05	4.00±0.10	4.00±0.10	2.00±0.05	8.00±0.20
	inch	0.065 ±0.008	0.094 ±0.008	0.059 ±0.004	0.138 ±0.002	0.157 ±0.004	0.157 ±0.004	0.079 ±0.002	0.315 ±0.008
CR1206	mm	2.00±0.20	3.60±0.20	1.50±0.10	3.50±0.05	4.00±0.10	4.00±0.10	2.00±0.05	8.00±0.20
	inch	0.079 ±0.008	0.142 ±0.002	0.059 ±0.004	0.138 ±0.002	0.157 ±0.004	0.157 ±0.004	0.079 ±0.002	0.315 ±0.008
CR1210	mm	2.80±0.10	3.50±0.10	1.50±0.10	3.50±0.05	4.00±0.10	4.00±0.10	2.00±0.05	8.00±0.20
	inch	0.110 ±0.004	0.138 ±0.004	0.059 ±0.004	0.138 ±0.002	0.157 ±0.004	0.157 ±0.004	0.079 ±0.002	0.315 ±0.008
CR2010	mm	2.90±0.10	5.30±0.10	1.50±0.10	5.50±0.05	4.00±0.10	4.00±0.10	2.00±0.05	12.0±0.10
	inch	0.114 ±0.004	0.209 ±0.004	0.059 ±0.004	0.216 ±0.002	0.157 ±0.004	0.157 ±0.004	0.079 ±0.002	0.472 ±0.004
CR2512	mm	3.40±0.10	6.60±0.10	1.50±0.10	5.50±0.05	4.00±0.10	4.00±0.10	2.00±0.05	12.0±0.10
	inch	0.134 ±0.004	0.260 ±0.004	0.059 ±0.004	0.216 ±0.002	0.157 ±0.004	0.157 ±0.004	0.079 ±0.002	0.315 ±0.004



## 7.Characteristics And Test Methods

### 7.1 Electrical characteristics test methods

#### 7.1.1 Resistance Value

Measurement of resistance take place by the bridge methods or by use of a measuring instrument corresponding accuracy, its accuracy being fully reliable with respect to tolerances on resistance. The applied voltage for measurement shall be as specified in Table as following.

Resistance	Voltage applied(V)
1Ω~100Ω	0.3VΩ
100Ω~1KΩ	1VΩ
1KΩ~10KΩ	3VΩ
10KΩ~100KΩ	10VΩ
100KΩ~1MΩ	25VΩ
1MΩ~10MΩ	50VΩ
10MΩ~aboveΩ	100VΩ

#### 7.1.2 Temperature Coefficient of Resistance

In according with 7.1.1 measure initial of resistor mounted on the test board, Then Keep the temperature at each step as following table, hold for 30 minutes after reaching a given temperature and measure resistance under the same condition as initial-value measurement. The temperature coefficient of resistance calculated from these measured values by the following formula.

$$\text{Temperature coefficient(ppm/°C)} = \frac{R - R_0}{R} * \frac{1}{t - t_0} * 10^6$$

Where R = Resistance value at tested temperature

R<sub>0</sub> = Initial resistance value

t = Actual measurement of tested temperature

t<sub>0</sub> = Initial temperature

STEP	TEMPERATURE
1	25±5°C
2	125±5°C





## Approval Specification for Thick Film Chip Resistors - Type **CR**

### 7.1.3 short-Time Overload

In accordance with 7.1.1 measure the initial of resistor mounted on the test socket, then apply to the resistor the voltage corresponding to 2.5 times rated voltage. However, in case the voltage corresponding to 2.5 times the rated voltage exceeds the maximum overload voltage, the maximum overload voltage shall be regarded as test voltage. Eliminate the voltage, leave aside with no load for 30 minutes and then measure resistance under the same condition as in initial-value measurement. At this time, the variation in relation to initial resistance shall be less than  $\pm(1.00\%+0.05\Omega)$  for 5% and less than  $\pm(0.5\%+0.05\Omega)$  for 1%.

$$\Delta R\% = \frac{R_2 - R_1}{R_1} * 100 \text{-----}(\%)$$

Where  $R_1$ =resistance at experiment front in ohms . ( $\Omega$ )

$R_2$ =resistance at experiment after in ohms . ( $\Omega$ )

### 7.1.4 Dielectric withstanding voltage

The applied test voltage shall be slow by increased form 0 V to maximum working voltage with DC voltage across electrode and the center of body for  $60\pm 5$ seconds. At this time there shall be no failure on the resistor as short circuit live, burning, breakdown, etc.

## 7.2 Mechanical Characteristics and Test Methods

### 7.2.1 Resistance to Soldering Heat

In accordance with 7.1.1, measure the initial value of a resistor Dip it in a soldering bath at  $260\pm 5^\circ\text{C}$  for  $10\pm 0.5$  seconds and take out at room temperature. Then, leave it aside for about one and measure resistance under the same condition as in initial value measurement. The variation in relation to the initial



## Approval Specification for Thick Film Chip Resistors - Type **CR**

resistance shall be less than,  $\pm(1.00\%+0.05\Omega)$  for 5% and less than  $\pm(0.5\%+0.05\Omega)$  for 1%, there being no failure in appearance and mechanical harm.

$$\Delta R\% = \frac{R_2 - R_1}{R_1} * 100 \text{-----}(\%)$$

Where R1=resistance at experiment front in ohms . ( $\Omega$ )

R2=resistance at experiment after in ohms . ( $\Omega$ )

### 7.2.2 Solderability

Dip the terminal in a flux (methanol solution containing rosin approx. 25% in weight) for one to two sec. and then dip into a soldering bath at  $245\pm 5^\circ\text{C}$  for  $2\pm 0.5\text{sec}$ . The solder to be used shall be JIS C 5202 6.5

### 7.2.3 Bending Strength

Test Method : JIS C 5202 6.1.4

The test printed circuit board equipped with the specimen SMD shall be bend. The specified amount of bend shall be maintained for  $5\pm 1\text{Sec}$  and the number of time shall be one .

Test Conditions : CHIP

Item	Test Time (Sec)	Amount of bend $+0.20(\text{mm})$
CHIP	$5\pm 1$	5 or 2 by type
POWER CHIP	$5\pm 1$	2
CHIP ARRAY	$5\pm 1$	1

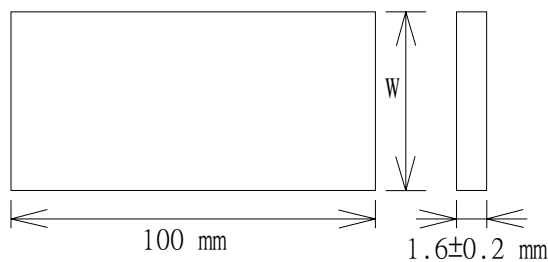



## Approval Specification for Thick Film Chip Resistors - Type CR

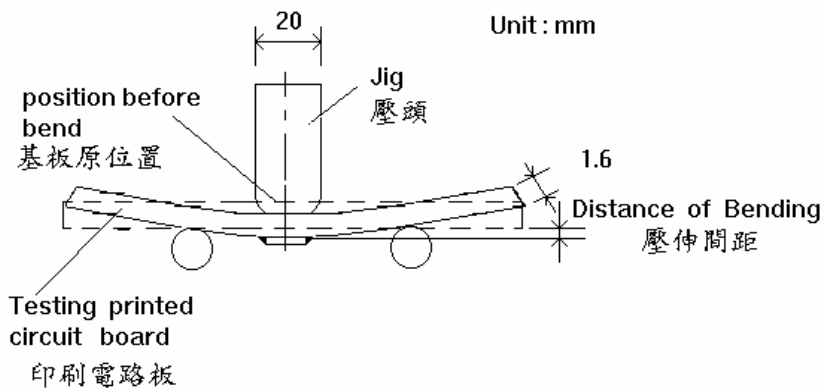
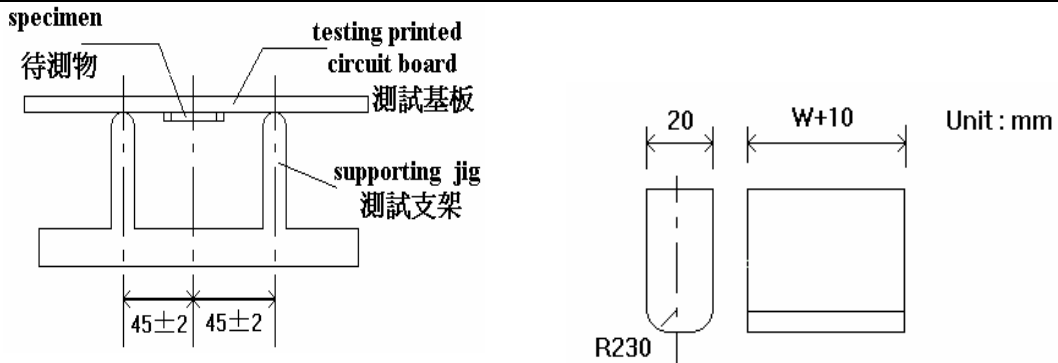

### 7.3 Temperature Cycling and Test Methods

#### 7.3.1 Low Temperature Operation

In accordance with MIL-STD-55342D PARA 4.7.4, measure the initial value of a resistor mounted on the test substrate and place it at the condition of  $25^{\circ}\text{C} \pm 3^{\circ}\text{C}$ , then change the chamber in condition at  $-65^{+0}_{-5}^{\circ}\text{C}$  for  $45^{+0}_{-5}$ mins at work voltage. Take it out at room temperature, leave aside for twenty-four hours and then measure resistance under the same condition as in initial-value measurement. At this time, the variation in relation to the initial resistance shall be below  $\pm(1.00\%+0.05\Omega)$  for 5% and shall be below  $\pm(0.5\%+0.05\Omega)$  for 1%, there being no mechanical damage.

$$\Delta R\% = \frac{R_2 - R_1}{R_1} * 100 \text{-----}(\%)$$

Where  $R_1$ =resistance at experiment front in ohms . ( $\Omega$ )

$R_2$ =resistance at experiment after in ohms . ( $\Omega$ )



### Approval Specification for Thick Film Chip Resistors - Type CR

#### 7.3.2 Moisture Resistance

In accordance with 7.1.1, measure the initial value of a resistor mounted on the test substrate . then, leave it in a thermal and humidity chamber condition for 1000 <sup>+24</sup>/<sub>-0</sub> hours , each step as following table. Take it out room temperature, leave aside for about one hour, and then measure resistance under the same condition as in initial-value measurement. At this time the variation in relation in to the initial resistance shall be below ±(2.00%+0.05Ω) for 5% and shall be below ± (0.5%+0.05Ω) for 1%, there being no mechanical damage.

Step	1	2	3	4	5	6	7	8	9	10	11
Temperature(°C)	65	65	25	65	65	25	25	-10	-10	25	25
Humidity(%)	92	92	92	92	92	92	92	0	0	0	92
Time(H:m)	2:30	3:00	2:30	2:30	3:00	2:30	1:30	0:30	3:00	0:30	2:30

$$\Delta R\% = \frac{R_2 - R_1}{R_1} * 100 \text{-----}(\%)$$

Where R1=resistance at experiment front in ohms . ( Ω )

R2=resistance at experiment after in ohms . ( Ω )

#### 7.3.3 Endurance for Humidity

In accordance with 7.1.1, measure the initial value of a resistor mounted on the test substrate . The specimen mounted as specified in the chamber at 40 ±2°C temperature and 90~95% relative humidity ,and then subjected to a voltage cycle consisting of rated D.C. voltage in article 3.4 application of 1h 30 mins and rest of 30 mins repeatedly for one the test durations given in 1000 <sup>+48</sup>/<sub>-0</sub> hours. Then, take it out at room temperature, leave aside for about one hour, and measure resistance under the same condition as in initial-value measurement. At this time, the variation in relation to the initial resistance shall be below ±(2.00%+0.05Ω) for 5% and shall be below ±(0.5%+0.05Ω) for 1%, there being no mechanical damage.

$$\Delta R\% = \frac{R_2 - R_1}{R_1} * 100 \text{-----}(\%)$$

Where R1=resistance at experiment front in ohms . ( Ω )

R2=resistance at experiment after in ohms . ( Ω )



## Approval Specification for Thick Film Chip Resistors - Type CR

### 7.3.4 Life

Test Method: MIL-STD-202F METHOD 108A

The specimen is measured for its resistance value in accordance with 1-1. The specimen mounted as specified in the chamber at the rated category temperature  $70\pm 2^{\circ}\text{C}$ , and with the rated d. c. voltage application  $1000^{+24}/_{-0}$  hours(42day). Next, the specimen is taken out of the test chamber, allowed to stand at room temperature without loaded for approximately 1h unless otherwise specified, measured for its resistance values again in accordance with 1-1. And then the variation in the resistance values taken before and after this test is calculated. At this time, the variation in relation to the initial resistance shall be below  $\pm(3.00\%+0.05\Omega)$  for 5% and shall be below  $\pm(1\%+0.05\Omega)$  for 1%, there being no mechanical damage.

$$\Delta R\% = \frac{R_2 - R_1}{R_1} * 100 \text{-----}(\%)$$

Where  $R_1$  = resistance at experiment front in ohms . ( $\Omega$ )

$R_2$  = resistance at experiment after in ohms . ( $\Omega$ )

### 7.3.5 Thermal shock

Test Method: MIL-STD-202F METHOD 107G

The specimen is measured for its resistance value in accordance with 1-1, and then placed in the test chamber. The test chamber at that temperature for  $125^{\circ}\text{C}$  and  $-55^{\circ}\text{C}$  it shall be 5 cycles. The specimen is allowed to stand at room temperature for 1 hr or more but not more than 2 hr, measured for its resistance value again in accordance with 1-1, and then the variation in the resistance values taken before and after this test is calculated. At this time, the variation in relation to the initial resistance shall be below  $\pm(1.00\%+0.05\Omega)$  for 5% and shall be below  $\pm(0.5\%+0.05\Omega)$  for 1%, there being no mechanical damage.

$$\Delta R\% = \frac{R_2 - R_1}{R_1} * 100 \text{-----}(\%)$$

Where  $R_1$  = resistance at experiment front in ohms . ( $\Omega$ )

$R_2$  = resistance at experiment after in ohms . ( $\Omega$ )



## Approval Specification for Thick Film Chip Resistors - Type **CR**

### 7.3.6 Peel force of top cover tape

The peel force of top cover tape shall be 0.1N to 0.7N(10 to 70 gf), when the top cover tape is pulled at a speed of 200 mm/min with the angle between the tape during peel and the direction of unreeling maintained at 165 to 180 degree as illustrated in Fig-10.



### 7.3.7 Recommend reflow soldering profile





### 波峰焊曲线

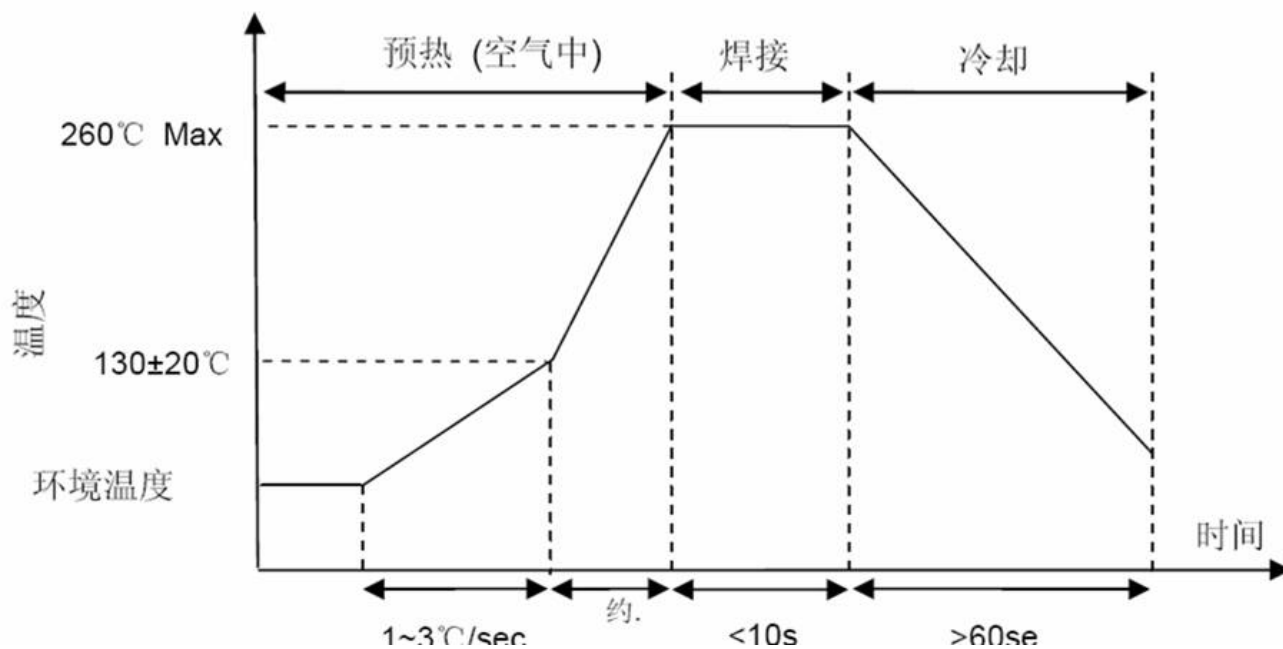

## X-ON Electronics

Largest Supplier of Electrical and Electronic Components

*Click to view similar products for [Thick Film Resistors - SMD category](#):*

*Click to view products by [LIZ manufacturer](#):*

Other Similar products are found below :

[CR-05FL7--150R](#) [CR-05FL7--19K6](#) [CR-05FL7--243R](#) [CR-05FL7--40K2](#) [CR-05FL7--698K](#) [CR-12FP4--324R](#) [CR-12JP4--680R](#)

[M55342K06B6E19RWL](#) [M55342K06B6E81RS3](#) [M55342M05B200DRWB](#) [M55342M06B4K70MS3](#) [MC0603-511-JTW](#) [742C083750JTR](#)

[MCR01MZPF1202](#) [MCR01MZPF1601](#) [MCR01MZPF1800](#) [MCR01MZPF6201](#) [MCR01MZPF9102](#) [MCR01MZPJ113](#) [MCR01MZPJ121](#)

[MCR01MZPJ125](#) [MCR01MZPJ751](#) [MCR03EZHZ103](#) [MCR03EZPF2004](#) [MCR03EZPJ270](#) [MCR03EZPJ821](#) [MCR10EZPF1102](#)

[MCR18EZPJ330](#) [RC0603F1473CS](#) [RC0603F150CS](#) [RC1005F1152CS](#) [RC1005F1182CS](#) [RC1005F1372CS](#) [RC1005F183CS](#)

[RC1005F1911CS](#) [RC1005F1912CS](#) [RC1005F203CS](#) [RC1005F2052CS](#) [RC1005F241CS](#) [RC1005F2431CS](#) [RC1005F3011CS](#)

[RC1005F303CS](#) [RC1005F4321CS](#) [RC1005F4642CS](#) [RC1005F471CS](#) [RC1005F4751CS](#) [RC1005F5621CS](#) [RC1005F6041CS](#)

[RC1005J106CS](#) [RC1005J121CS](#)