



Approval Specification for Thick Film Chip Resistors - Type **CR**

1. Scope

This specification prescribes lead free thick film chip resistors for use in electronics system

2. Designation

Chip Resistor 0805 1/8W ±5% 4K7 Ω

CR0805J80472G



| Series | Size Code | Tolerance | Power Rating | Value | SPECIAL VALUE |
|-----------|-----------|-----------|--------------|-----------|---------------|
| Name | 0201 | B=± 0.1% | 1= 1W | 4digitals | |
| Product.. | 0402 | C=± 0.25% | 2= 1/2W | 49R9=49.9 | V= bulk |
| CR=Chip | 0603 | D=± 0.5% | 3= 1/3W | 0472=4K7 | D= special |
| Resistor | 0805 | F=± 1% | 4= 1/4W | 0103=10K | requirement |
| | 1206 | G=± 2% | 8= 1/8W | 0564=560K | |
| | 1210 | J=± 5% | A= 1/10W | | |
| | 2010 | K=± 10% | F= 1/16W | | |
| | 2512 | | H=1/20W | | |

2.2 Remark:

(1) Common code for chip resistors

(2) Normal resistance value for tolerance ±0.1% , ±0.25%, ±0.5% ±1% :

the first three digits are significant figures of resistance value and the fourth one denotes the power number of 10, (10^X)

Example: 330 ohm: 3300, 4.7K ohm: 4701

22K ohm: 2202, 100K ohm: 1003

(3) Normal resistance value for tolerance ±2% , ±5%, ±10%:

the first digit is zero, the second and third digit are significant figures of resistance value and the fourth one denotes the power number of 10, (10^X)

Example: 330 ohm: 0331, 4.7K ohm: 0472

22K ohm: 0223, 100K ohm: 0104

(3) EXPLANATION OF PART NUMBER FOR 0603, ±1%

Approval Specification for Thick Film Chip Resistors - Type **CR**

EIA-96 Marking

| | | | | | | | |
|--------------|--------------|--------------|--------------|--------------|--------------|--------------|--------------|
| code R Value | code R Value | code R Value | code R Value | code R Value | code R Value | code R Value | code R Value |
| 01 100 | 13 133 | 25 178 | 37 237 | 49 316 | 61 422 | 73 562 | 85 750 |
| 02 102 | 14 137 | 26 182 | 38 243 | 50 324 | 62 432 | 74 576 | 86 768 |
| 03 105 | 15 140 | 27 187 | 39 249 | 51 332 | 63 442 | 75 590 | 87 787 |
| 04 107 | 16 143 | 28 191 | 40 255 | 52 340 | 64 453 | 76 604 | 88 806 |
| 05 110 | 17 147 | 29 196 | 41 261 | 53 348 | 65 464 | 77 619 | 89 825 |
| 06 113 | 18 150 | 30 200 | 42 267 | 54 357 | 66 475 | 78 634 | 90 845 |
| 07 115 | 19 154 | 31 205 | 43 274 | 55 365 | 67 487 | 79 649 | 91 866 |
| 08 118 | 20 158 | 32 210 | 44 280 | 56 374 | 68 499 | 80 665 | 92 887 |
| 09 121 | 21 162 | 33 215 | 45 287 | 57 383 | 69 511 | 81 681 | 93 909 |
| 10 124 | 22 165 | 34 221 | 46 294 | 58 392 | 70 523 | 82 698 | 94 931 |
| 11 127 | 23 169 | 35 226 | 47 301 | 59 402 | 71 536 | 83 715 | 95 953 |
| 12 130 | 24 174 | 36 223 | 48 309 | 60 412 | 72 549 | 84 732 | 96 976 |

This table shows the first two digits for the three-digit EIA-96 part marking scheme the third character is a letter multiplier:

$Y=10^{-2}$, $X=10^{-1}$, $A=10^0$, $B=10^1$, $C=10^2$, $D=10^3$, $E=10^4$, $F=10^5$

- (4) If the resistance value is not found in the table for 0603 product, will use normal three digits to show the value, but will add a special mark “-” under the three digits. Example as following:

“ 331 ” indicates that it is 0603 $\pm 1\%$ 330ohm product.

3. Rating

3.1 Rated Power (%)

Rated power shall be load power corresponding to normal wattage suitable for continuous use at 70°C ambient temperature in case the ambient temperature exceeds 70°C reduce the load power in accordance with derating curve shown as

| TYPE | Rated Power | Max. Working Voltage | Max. Overload Voltage |
|--------|-------------|----------------------|-----------------------|
| CR0201 | 1/20W | 25V | 50V |
| CR0402 | 1/16W | 50V | 100V |
| CR0603 | 1/10W | 50V | 100V |
| CR0805 | 1/8W | 150V | 300V |
| CR1206 | 1/4W | 200V | 400V |
| CR1210 | 1/3W | 200V | 400V |
| CR2010 | 1/2W | 200V | 400V |
| CR2512 | 1W | 200V | 400V |



Approval Specification for Thick Film Chip Resistors - Type CR

3.2 Derating Curve



3.3 Operating Temperature Range -55°C~+125°C ;

storage condition is 5~30°C, 30~75%RH.

3.4 Rated Voltage

The rated voltage is calculated from the rated power and normal resistance by the following formula: $E = \sqrt{RP}$

Where : E : Rated Voltage (V)

P : Rated Power (W)

R : Normal Resistance (ohm)

In case the value calculated by the formula exceed the maximum working voltage as 3.1 the maximum working voltage shall be regarded as rated

3.5 Resistance Range and Resistance Tolerance

| TYPE NO. | Tolerance (%) | Symbol | Resistance Range(ohm) | Standard Resistance Values |
|--------------------------------------|---------------|--------|---------------------------|----------------------------|
| CR0402 CR0603 CR0805 CR1206 | ±0.5% | D | 10~1M | E96 |
| CR0201 | ±1% | F | 1R0~10M | E96 |
| CR0402 | ±2% | G | | |
| CR0603 | ±5% | J | 1R0~22M (0201:1R0~10M) | E24 |
| CR0805 | ±10% | K | | |
| CR1206 | ±20% | M | | |
| CR1210 | | | | |
| CR2010 | | | | |
| CR2512 | | | | |



Approval Specification for Thick Film Chip Resistors - Type **CR**

4. Dimension

4.1 Dimension

| DIMENSIONS | | | | | |
|------------|-----------|-----------|-----------|-----------|-----------|
| | Type | L | W | T | E |
| CR0201 | 0.60±0.03 | 0.30±0.03 | 0.23±0.03 | 0.15±0.05 | 0.15±0.05 |
| CR0402 | 1.00±0.05 | 0.50±0.05 | 0.35±0.05 | 0.15±0.10 | 0.20±0.10 |
| CR0603 | 1.60±0.15 | 0.80±0.10 | 0.45±0.10 | 0.25±0.20 | 0.30±0.20 |
| CR0805 | 2.00±0.15 | 1.25±0.15 | 0.50±0.10 | 0.35±0.20 | 0.40±0.20 |
| CR1206 | 3.10±0.15 | 1.60±0.15 | 0.55±0.10 | 0.45±0.25 | 0.40±0.25 |
| CR1210 | 3.10±0.15 | 2.50±0.15 | 0.55±0.15 | 0.35±0.25 | 0.60±0.35 |
| CR2010 | 5.00±0.20 | 2.50±0.20 | 0.55±0.15 | 0.65±0.25 | 0.50±0.25 |
| CR2512 | 6.25±0.20 | 3.10±0.20 | 0.55±0.15 | 0.85±0.25 | 0.95±0.25 |

4.2. Construction and materials



Approval Specification for Thick Film Chip Resistors - Type **CR**

| No. | construction | Major material |
|-----|---------------------------|----------------|
| 1 | Ceramic substrate | Al2O3 |
| 2 | Conductive layer | Ag |
| 3 | Side conductive layer | NiCr |
| 4 | Resistive layer | RuO2 + glass |
| 5 | Inner protective layer | Glass |
| 6 | Protective layer | Epoxy |
| 7 | Marking | Epoxy |
| 8 | Termination barrier layer | Ni |
| 9 | Termination layer | Matte Tin |

4.3 Electrical Characteristics:

| Type | Rated Power at 70°C | Max. Working Voltage | Max. Overload Voltage | T.C.R (ppm/°C) | Resistance Range | | | | Jumper Resistance Value | Jumper Rated Current |
|------|---------------------|----------------------|-----------------------|----------------|------------------|------------|------------|------------|-------------------------|----------------------|
| | | | | | D(±0.5%) E96 | F(±1%) E96 | G(±2%) E24 | J(±5%) E24 | | |
| 0201 | 1/20W | 25V | 50V | ±600 | ----- | 1Ω~25Ω | 1Ω~25Ω | 1Ω~25Ω | 50mΩ MAX | 0.5A |
| | | | | ±250 | ----- | 25Ω~10MΩ | 25Ω~10MΩ | 25Ω~10MΩ | | |
| 0402 | 1/16W | 50 V | 100V | +500~-250 | ----- | 1Ω~10Ω | 1Ω~10Ω | 1Ω~10Ω | 50mΩ MAX | 1A |
| | | | | ±200 | ----- | 10Ω~1MΩ | 10Ω~10MΩ | 10Ω~22MΩ | | |
| | | | | ±100 | ----- | ----- | ----- | ----- | | |
| 0603 | 1/10W | 50V | 100V | +500~-250 | ----- | 1Ω~10Ω | 1Ω~10Ω | 1Ω~10Ω | 50mΩ MAX | 1A |
| | | | | ±200 | ----- | ----- | 10Ω~10MΩ | 10Ω~22MΩ | | |
| | | | | ±100 | ----- | 10Ω~1MΩ | 10Ω~10MΩ | ----- | | |
| 0805 | 1/8W | 150V | 300V | +500~-250 | ----- | 1Ω~10Ω | 1Ω~10Ω | 1Ω~10Ω | 50mΩ MAX | 1.5A |
| | | | | ±200 | ----- | ----- | 10Ω~10MΩ | 10Ω~22MΩ | | |
| | | | | ±100 | ----- | 10Ω~1MΩ | 10Ω~10MΩ | ----- | | |
| 1206 | 1/4W | 200V | 400V | +500~-250 | ----- | 1Ω~10Ω | 1Ω~10Ω | 1Ω~10Ω | 50mΩ MAX | 1.9A |
| | | | | ±200 | ----- | ----- | 10Ω~10MΩ | 10Ω~22MΩ | | |
| | | | | ±100 | ----- | 10Ω~1MΩ | 10Ω~10MΩ | ----- | | |
| 1210 | 1/3W | 200V | 400V | +500~-250 | ----- | 1Ω~10Ω | 1Ω~10Ω | 1Ω~10Ω | 50mΩ MAX | 2.2A |
| | | | | ±200 | ----- | ----- | 10Ω~10MΩ | 10Ω~22MΩ | | |
| | | | | ±100 | ----- | 10Ω~10MΩ | ----- | ----- | | |
| 2010 | 1/2W | 200V | 400V | +500~-250 | ----- | 1Ω~10Ω | 1Ω~10Ω | 1Ω~10Ω | 50mΩ MAX | 3A |
| | | | | ±200 | ----- | ----- | 10Ω~10MΩ | 10Ω~22MΩ | | |
| | | | | ±100 | ----- | 10Ω~10MΩ | ----- | ----- | | |
| 2512 | 1W | 200V | 400V | +500~-250 | ----- | 1Ω~10Ω | 1Ω~10Ω | 1Ω~10Ω | 50mΩ MAX | 3A |
| | | | | ±200 | ----- | ----- | 10Ω~10MΩ | 10Ω~22MΩ | | |
| | | | | ±100 | ----- | 10Ω~10MΩ | ----- | ----- | | |

*ZERO OHM JUMPER<0.050HM

Approval Specification for Thick Film Chip Resistors - Type **CR****5. Environmental performance**

| Description | Specification Limits | Test Methods |
|--|---|---|
| Temperature Coefficient | (over 10ohm) ± 200 ppm/ $^{\circ}\text{C}$ Max. (lower 10ohm) $+500 \sim -250$ ppm/ $^{\circ}\text{C}$ | JIS C5202 5.2 |
| Short Time Overload | $\pm(1.00\%+0.05\text{ohm})$ Max. | JIS C5202 5.5 |
| Resistance to Soldering Heat | $\pm(1.00\%+0.05\text{ohm})$ Max. | JIS C5202 6.4 |
| Solderability | 95% Coverage Min. | JIS C5202 6.4 |
| Load Life | $\pm(3.00\%+0.05\text{ohm})$ Max. | JIS C5202 7.10 |
| Load Life Humidity | $\pm(2.00\%+0.05\text{ohm})$ Max. | JIS C5202 7.5 |
| Temperature Cycle | $\pm(2.00\%+0.05\text{ohm})$ Max. | JIS C5202 7.6 |
| Component high temperature resistance | $\pm(1.00\%+0.05\text{ohm})$ Max. | $<260^{\circ}\text{C}$ 10second 3times |
| Component rework/hand soldering temperature resistance | Avoid solder iron tip direct touch the components body | Approx. 350°C for 3seconds |
| MSL (moisture sensitive level) | Level 1 | J-STD-020C |

6. Tapping Specification

| Dimensions | | A | B | C | F | W |
|------------|------|-------------------|-------------------|-------------------|-------------------|-------------------|
| CR0201 | mm | 178 ± 2.0 | 60.0 ± 1.0 | 13.5 ± 0.5 | 11.4 ± 0.1 | 9.00 ± 0.3 |
| CR0402 | | | | | | |
| CR0603 | Inch | 7.008 ± 0.079 | 2.362 ± 0.039 | 0.531 ± 0.020 | 0.449 ± 0.039 | 0.354 ± 0.012 |
| CR0805 | | | | | | |
| CR1206 | | | | | | |
| CR1210 | | | | | | |
| CR2010 | mm | 178 ± 2.0 | 60.0 ± 1.0 | 13.5 ± 0.5 | 15.4 ± 1.0 | 13.0 ± 0.3 |
| CR2512 | Inch | 7.008 ± 0.079 | 2.362 ± 0.039 | 0.531 ± 0.020 | 0.606 ± 0.039 | 0.512 ± 0.012 |

Remark: (1)CR0201/CR0402 Quantity per Reel 10,000 pcs/Reel

(2)CR2010/CR2512 Quantity per Reel 4,000 pcs/Reel

Reel

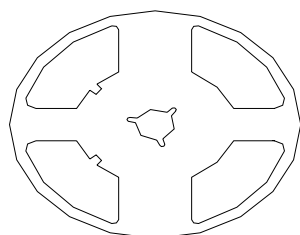
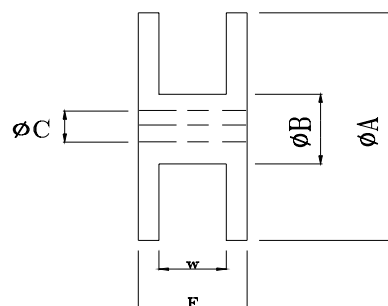
Standard Quantity per Reel
5,000 pcs/Reel



Approval Specification for Thick Film Chip Resistors - Type **CR**

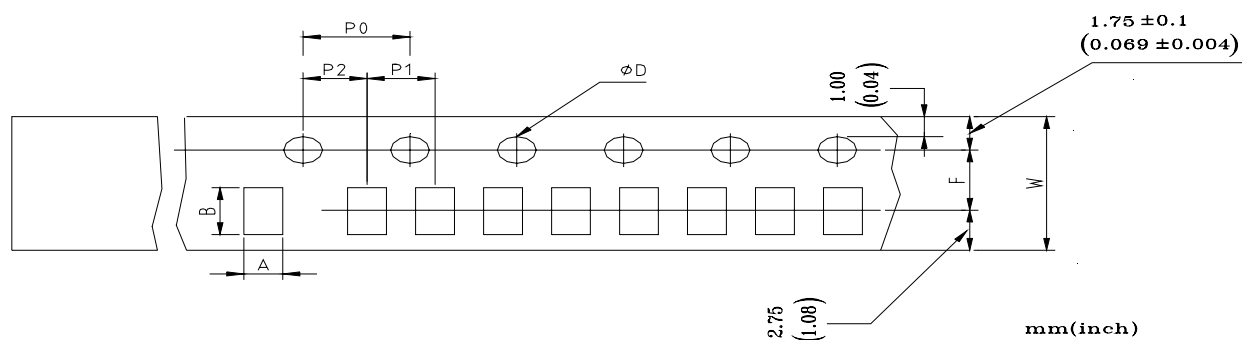

| Dimensions | | A | B | D | F | P0 | P1 | P2 | W |
|------------|------|-----------------|-----------------|-----------------|-----------------|-----------------|-----------------|-----------------|-----------------|
| CR0201 | mm | 0.38±0.05 | 0.68±0.05 | 1.50±0.10 | 3.50±0.05 | 4.00±0.10 | 2.00±0.10 | 2.00±0.05 | 8.00±0.20 |
| | inch | 0.015 ±0.002 | 0.027 ±0.002 | 0.059 ±0.004 | 0.138 ±0.002 | 0.157 ±0.004 | 0.079 ±0.004 | 0.079 ±0.002 | 0.315 ±0.008 |
| CR0402 | mm | 0.65±0.10 | 1.15±0.10 | 1.50±0.10 | 3.50±0.05 | 4.00±0.10 | 2.00±0.10 | 2.00±0.05 | 8.00±0.20 |
| | inch | 0.026 ±0.004 | 0.045 ±0.004 | 0.059 ±0.004 | 0.138 ±0.002 | 0.157 ±0.004 | 0.079 ±0.004 | 0.079 ±0.002 | 0.315 ±0.008 |
| CR0603 | mm | 1.10±0.10 | 1.90±0.10 | 1.50±0.10 | 3.50±0.05 | 4.00±0.10 | 4.00±0.10 | 2.00±0.05 | 8.00±0.20 |
| | inch | 0.043 ±0.004 | 0.075 ±0.004 | 0.059 ±0.004 | 0.138 ±0.002 | 0.157 ±0.004 | 0.157 ±0.004 | 0.079 ±0.002 | 0.315 ±0.008 |
| CR0805 | mm | 1.65±0.20 | 2.40±0.20 | 1.50±0.10 | 3.50±0.05 | 4.00±0.10 | 4.00±0.10 | 2.00±0.05 | 8.00±0.20 |
| | inch | 0.065 ±0.008 | 0.094 ±0.008 | 0.059 ±0.004 | 0.138 ±0.002 | 0.157 ±0.004 | 0.157 ±0.004 | 0.079 ±0.002 | 0.315 ±0.008 |
| CR1206 | mm | 2.00±0.20 | 3.60±0.20 | 1.50±0.10 | 3.50±0.05 | 4.00±0.10 | 4.00±0.10 | 2.00±0.05 | 8.00±0.20 |
| | inch | 0.079 ±0.008 | 0.142 ±0.002 | 0.059 ±0.004 | 0.138 ±0.002 | 0.157 ±0.004 | 0.157 ±0.004 | 0.079 ±0.002 | 0.315 ±0.008 |
| CR1210 | mm | 2.80±0.10 | 3.50±0.10 | 1.50±0.10 | 3.50±0.05 | 4.00±0.10 | 4.00±0.10 | 2.00±0.05 | 8.00±0.20 |
| | inch | 0.110 ±0.004 | 0.138 ±0.004 | 0.059 ±0.004 | 0.138 ±0.002 | 0.157 ±0.004 | 0.157 ±0.004 | 0.079 ±0.002 | 0.315 ±0.008 |
| CR2010 | mm | 2.90±0.10 | 5.30±0.10 | 1.50±0.10 | 5.50±0.05 | 4.00±0.10 | 4.00±0.10 | 2.00±0.05 | 12.0±0.10 |
| | inch | 0.114 ±0.004 | 0.209 ±0.004 | 0.059 ±0.004 | 0.216 ±0.002 | 0.157 ±0.004 | 0.157 ±0.004 | 0.079 ±0.002 | 0.472 ±0.004 |
| CR2512 | mm | 3.40±0.10 | 6.60±0.10 | 1.50±0.10 | 5.50±0.05 | 4.00±0.10 | 4.00±0.10 | 2.00±0.05 | 12.0±0.10 |
| | inch | 0.134 ±0.004 | 0.260 ±0.004 | 0.059 ±0.004 | 0.216 ±0.002 | 0.157 ±0.004 | 0.157 ±0.004 | 0.079 ±0.002 | 0.315 ±0.004 |



7.Characteristics And Test Methods

7.1 Electrical characteristics test methods

7.1.1 Resistance Value

Measurement of resistance take place by the bridge methods or by use of a measuring instrument corresponding accuracy, its accuracy being fully reliable with respect to tolerances on resistance. The applied voltage for measurement shall be as specified in Table as following.

| Resistance | Voltage applied(V) |
|-------------|--------------------|
| 1Ω~100Ω | 0.3VΩ |
| 100Ω~1KΩ | 1VΩ |
| 1KΩ~10KΩ | 3VΩ |
| 10KΩ~100KΩ | 10VΩ |
| 100KΩ~1MΩ | 25VΩ |
| 1MΩ~10MΩ | 50VΩ |
| 10MΩ~aboveΩ | 100VΩ |

7.1.2 Temperature Coefficient of Resistance

In according with 7.1.1 measure initial of resistor mounted on the test board, Then Keep the temperature at each step as following table, hold for 30 minutes after reaching a given temperature and measure resistance under the same condition as initial-value measurement. The temperature coefficient of resistance calculated from these measured values by the following formula.

$$\text{Temperature coefficient(ppm/°C)} = \frac{R - R_0}{R} * \frac{1}{t - t_0} * 10^6$$

Where R = Resistance value at tested temperature

R₀ = Initial resistance value

t = Actual measurement of tested temperature

t₀ = Initial temperature

| STEP | TEMPERATURE |
|------|-------------|
| 1 | 25±5°C |
| 2 | 125±5°C |



Approval Specification for Thick Film Chip Resistors - Type **CR**

7.1.3 short-Time Overload

In accordance with 7.1.1 measure the initial of resistor mounted on the test socket, then apply to the resistor the voltage corresponding to 2.5 times rated voltage. However, in case the voltage corresponding to 2.5 times the rated voltage exceeds the maximum overload voltage, the maximum overload voltage shall be regarded as test voltage. Eliminate the voltage, leave aside with no load for 30 minutes and then measure resistance under the same condition as in initial-value measurement. At this time, the variation in relation to initial resistance shall be less than $\pm(1.00\%+0.05\Omega)$ for 5% and less than $\pm(0.5\%+0.05\Omega)$ for 1%.

$$\Delta R\% = \frac{R_2 - R_1}{R_1} * 100 \text{-----}(\%)$$

Where R_1 =resistance at experiment front in ohms . (Ω)

R_2 =resistance at experiment after in ohms . (Ω)

7.1.4 Dielectric withstanding voltage

The applied test voltage shall be slow by increased form 0 V to maximum working voltage with DC voltage across electrode and the center of body for 60 ± 5 seconds. At this time there shall be no failure on the resistor as short circuit live, burning, breakdown, etc.

7.2 Mechanical Characteristics and Test Methods

7.2.1 Resistance to Soldering Heat

In accordance with 7.1.1, measure the initial value of a resistor Dip it in a soldering bath at $260\pm 5^\circ\text{C}$ for 10 ± 0.5 seconds and take out at room temperature. Then, leave it aside for about one and measure resistance under the same condition as in initial value measurement. The variation in relation to the initial



Approval Specification for Thick Film Chip Resistors - Type **CR**

resistance shall be less than, $\pm(1.00\%+0.05\Omega)$ for 5% and less than $\pm(0.5\%+0.05\Omega)$ for 1%, there being no failure in appearance and mechanical harm.

$$\Delta R\% = \frac{R_2 - R_1}{R_1} * 100 \text{-----}(\%)$$

Where R1=resistance at experiment front in ohms . (Ω)

R2=resistance at experiment after in ohms . (Ω)

7.2.2 Solderability

Dip the terminal in a flux (methanol solution containing rosin approx. 25% in weight) for one to two sec. and then dip into a soldering bath at $245\pm 5^\circ\text{C}$ for $2\pm 0.5\text{sec}$. The solder to be used shall be JIS C 5202 6.5

7.2.3 Bending Strength

Test Method : JIS C 5202 6.1.4

The test printed circuit board equipped with the specimen SMD shall be bend. The specified amount of bend shall be maintained for $5\pm 1\text{Sec}$ and the number of time shall be one .

Test Conditions : CHIP

| Item | Test Time (Sec) | Amount of bend $+0.20(\text{mm})$ |
|------------|-----------------|-----------------------------------|
| CHIP | 5 ± 1 | 5 or 2 by type |
| POWER CHIP | 5 ± 1 | 2 |
| CHIP ARRAY | 5 ± 1 | 1 |

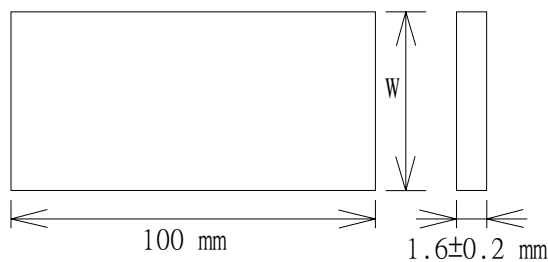



Approval Specification for Thick Film Chip Resistors - Type CR

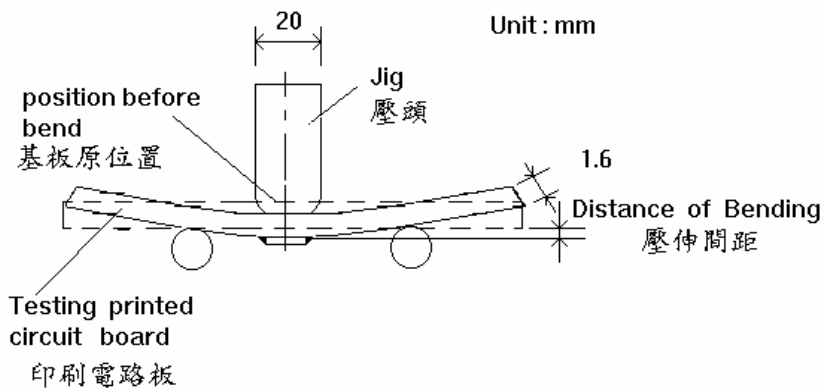
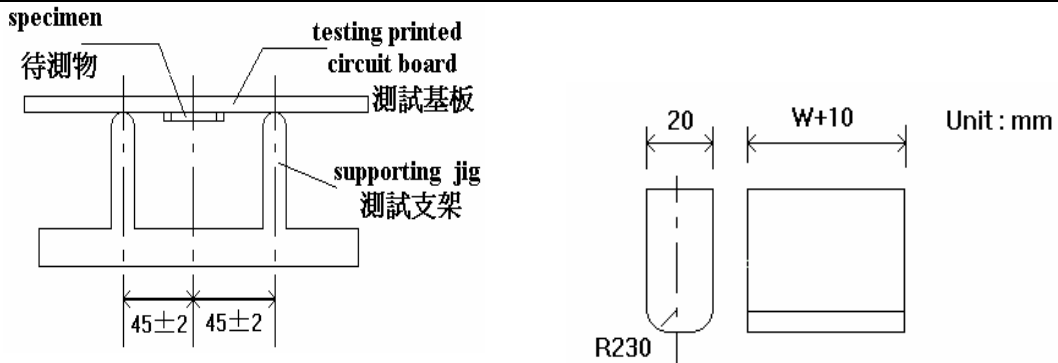

7.3 Temperature Cycling and Test Methods

7.3.1 Low Temperature Operation

In accordance with MIL-STD-55342D PARA 4.7.4, measure the initial value of a resistor mounted on the test substrate and place it at the condition of $25^{\circ}\text{C} \pm 3^{\circ}\text{C}$, then change the chamber in condition at $-65^{+0}_{-5}^{\circ}\text{C}$ for 45^{+0}_{-5} mins at work voltage. Take it out at room temperature, leave aside for twenty-four hours and then measure resistance under the same condition as in initial-value measurement. At this time, the variation in relation to the initial resistance shall be below $\pm(1.00\%+0.05\Omega)$ for 5% and shall be below $\pm(0.5\%+0.05\Omega)$ for 1%, there being no mechanical damage.

$$\Delta R\% = \frac{R_2 - R_1}{R_1} * 100 \text{-----}(\%)$$

Where R_1 =resistance at experiment front in ohms . (Ω)

R_2 =resistance at experiment after in ohms . (Ω)



Approval Specification for Thick Film Chip Resistors - Type CR

7.3.2 Moisture Resistance

In accordance with 7.1.1, measure the initial value of a resistor mounted on the test substrate . then, leave it in a thermal and humidity chamber condition for 1000 ⁺²⁴/₋₀ hours , each step as following table. Take it out room temperature, leave aside for about one hour, and then measure resistance under the same condition as in initial-value measurement. At this time the variation in relation in to the initial resistance shall be below ±(2.00%+0.05Ω) for 5% and shall be below ± (0.5%+0.05Ω) for 1%, there being no mechanical damage.

| Step | 1 | 2 | 3 | 4 | 5 | 6 | 7 | 8 | 9 | 10 | 11 |
|-----------------|------|------|------|------|------|------|------|------|------|------|------|
| Temperature(°C) | 65 | 65 | 25 | 65 | 65 | 25 | 25 | -10 | -10 | 25 | 25 |
| Humidity(%) | 92 | 92 | 92 | 92 | 92 | 92 | 92 | 0 | 0 | 0 | 92 |
| Time(H:m) | 2:30 | 3:00 | 2:30 | 2:30 | 3:00 | 2:30 | 1:30 | 0:30 | 3:00 | 0:30 | 2:30 |

$$\Delta R\% = \frac{R_2 - R_1}{R_1} * 100 \text{-----}(\%)$$

Where R1=resistance at experiment front in ohms . (Ω)

R2=resistance at experiment after in ohms . (Ω)

7.3.3 Endurance for Humidity

In accordance with 7.1.1, measure the initial value of a resistor mounted on the test substrate . The specimen mounted as specified in the chamber at 40 ±2°C temperature and 90~95% relative humidity , and then subjected to a voltage cycle consisting of rated D.C. voltage in article 3.4 application of 1h 30 mins and rest of 30 mins repeatedly for one the test durations given in 1000 ⁺⁴⁸/₋₀ hours. Then, take it out at room temperature, leave aside for about one hour, and measure resistance under the same condition as in initial-value measurement. At this time, the variation in relation to the initial resistance shall be below ±(2.00%+0.05Ω) for 5% and shall be below ±(0.5%+0.05Ω) for 1%, there being no mechanical damage.

$$\Delta R\% = \frac{R_2 - R_1}{R_1} * 100 \text{-----}(\%)$$

Where R1=resistance at experiment front in ohms . (Ω)

R2=resistance at experiment after in ohms . (Ω)



Approval Specification for Thick Film Chip Resistors - Type CR

7.3.4 Life

Test Method: MIL-STD-202F METHOD 108A

The specimen is measured for its resistance value in accordance with 1-1. The specimen mounted as specified in the chamber at the rated category temperature $70\pm 2^{\circ}\text{C}$, and with the rated d. c. voltage application $1000^{+24}/_{-0}$ hours(42day). Next, the specimen is taken out of the test chamber, allowed to stand at room temperature without loaded for approximately 1h unless otherwise specified, measured for its resistance values again in accordance with 1-1. And then the variation in the resistance values taken before and after this test is calculated. At this time, the variation in relation to the initial resistance shall be below $\pm(3.00\%+0.05\Omega)$ for 5% and shall be below $\pm(1\%+0.05\Omega)$ for 1%, there being no mechanical damage.

$$\Delta R\% = \frac{R_2 - R_1}{R_1} * 100 \text{-----}(\%)$$

Where R_1 =resistance at experiment front in ohms . (Ω)

R_2 =resistance at experiment after in ohms . (Ω)

7.3.5 Thermal shock

Test Method: MIL-STD-202F METHOD 107G

The specimen is measured for its resistance value in accordance with 1-1, and then placed in the test chamber. The test chamber at that temperature for 125°C and -55°C it shall be 5 cycles. The specimen is allowed to stand at room temperature for 1 hr or more but not more than 2 hr, measured for its resistance value again in accordance with 1-1, and then the variation in the resistance values taken before and after this test is calculated. At this time, the variation in relation to the initial resistance shall be below $\pm(1.00\%+0.05\Omega)$ for 5% and shall be below $\pm(0.5\%+0.05\Omega)$ for 1%, there being no mechanical damage.

$$\Delta R\% = \frac{R_2 - R_1}{R_1} * 100 \text{-----}(\%)$$

Where R_1 =resistance at experiment front in ohms . (Ω)

R_2 =resistance at experiment after in ohms . (Ω)



Approval Specification for Thick Film Chip Resistors - Type **CR**

7.3.6 Peel force of top cover tape

The peel force of top cover tape shall be 0.1N to 0.7N(10 to 70 gf), when the top cover tape is pulled at a speed of 200 mm/min with the angle between the tape during peel and the direction of unreeling maintained at 165 to 180 degree as illustrated in Fig-10.



7.3.7 Recommend reflow soldering profile





Approval Specification for Thick Film Chip Resistors - Type **CR**

波峰焊曲线

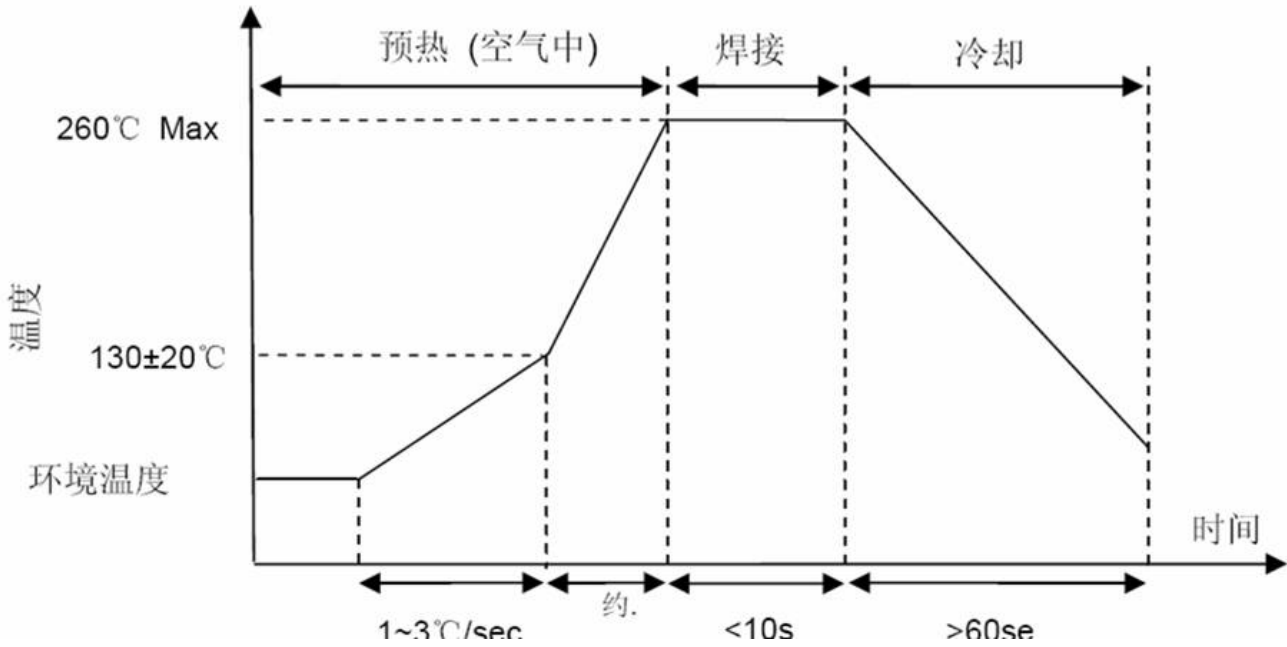

X-ON Electronics

Largest Supplier of Electrical and Electronic Components

Click to view similar products for [Thick Film Resistors - SMD category](#):

Click to view products by [LIZ manufacturer](#):

Other Similar products are found below :

[CR-05FL7--150R](#) [CR-05FL7--698K](#) [CR-12FP4--324R](#) [CR-12JP4--680R](#) [M55342K06B10D0RS6](#) [M55342K06B14E0RS6](#)
[M55342K06B1E78RS3](#) [M55342K06B24E9RS6](#) [M55342K06B6E19RWL](#) [M55342K06B6E81RS3](#) [M55342M05B200DRWB](#)
[M55342M06B4K70MS3](#) [MC0603-511-JTW](#) [742C083750JTR](#) [MCR01MZPF1202](#) [MCR01MZPF1601](#) [MCR01MZPF1800](#)
[MCR01MZPF6201](#) [MCR01MZPF9102](#) [MCR01MZPJ113](#) [MCR01MZPJ121](#) [MCR01MZPJ125](#) [MCR01MZPJ751](#) [MCR03EZHJ103](#)
[MCR03EZPF2004](#) [MCR03EZPJ270](#) [MCR03EZPJ821](#) [MCR10EZPF1102](#) [MCR10EZPF2700](#) [MCR18EZPJ330](#) [RC1005F1152CS](#)
[RC1005F1182CS](#) [RC1005F1372CS](#) [RC1005F183CS](#) [RC1005F1911CS](#) [RC1005F1912CS](#) [RC1005F203CS](#) [RC1005F2052CS](#)
[RC1005F241CS](#) [RC1005F2431CS](#) [RC1005F3011CS](#) [RC1005F303CS](#) [RC1005F4321CS](#) [RC1005F4642CS](#) [RC1005F471CS](#)
[RC1005F4751CS](#) [RC1005F5621CS](#) [RC1005F6041CS](#) [RC1005J106CS](#) [RC1005J121CS](#)