

1 2 3 4 5 6 7 8

REV.	ECN NO./DESCRIPTION	DATE
8	N150637	12/10'15
8A	R160606	06/27'17
9	N170379	07/27'17

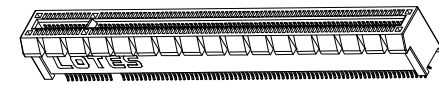
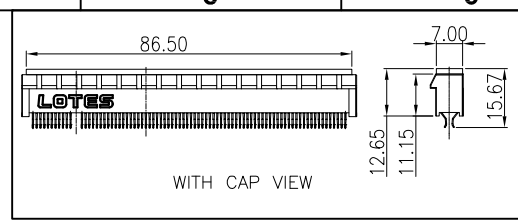
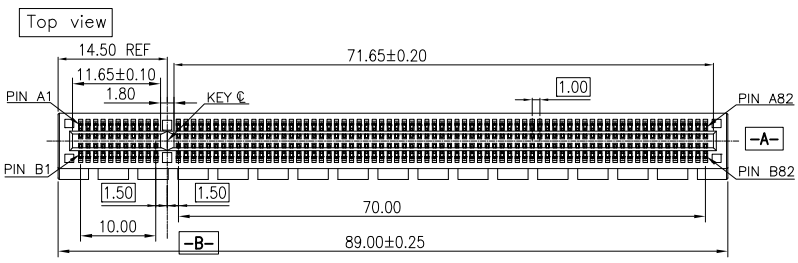

3D VIEW

- NOTES:
- MATERIAL:
HOUSING:HIGH TEMPERATURE THERMOPLASTIC(SEE TABLE)
TERMINAL:PHOSPHOR BRONZE(SEE TABLE)
 - FINISH:
TERMINAL: 50u" NI PLATING OVER ALL;
100u" MATTE Sn PLATING ON SOLDER TAIL;
GOLD PLATING ON CONTACT AREA.
 - MECHANICAL SPEC:
DURABILITY : 50 MATING CYCLES.
RETENTION FORCE : 0.40 kgf MIN PER PIN.
MATING FORCE : 1.15N MAX PER PIN.
UNMATING FORCE : 0.15N MIN PER PAIR.
 - ELECTRICAL SPEC:
CURRENT RATING: 1.1A.
CONTACT RESISTANCE: 30 MILLIOHMS MAX. INITIAL.
INSULATION RESISTANCE: 1000 MEGOHMS MIN.
DIELECTRIC WITHSTANDING VOLTAGE: 500V AC MIN.
 - IR REFLOW:
THE TEMPERATURE SHALL BE 260+/-5°C MAINTAINING 10+/-2 SECONDS
 - RoHS COMPLIANT OR HALOGEN FREE COMPLIANT.
 - PRODUCT NUMBER NOTE:
AAA - PCI - *** - K**

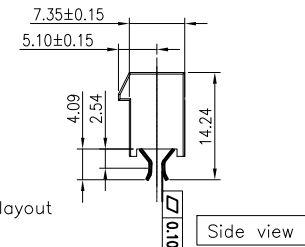
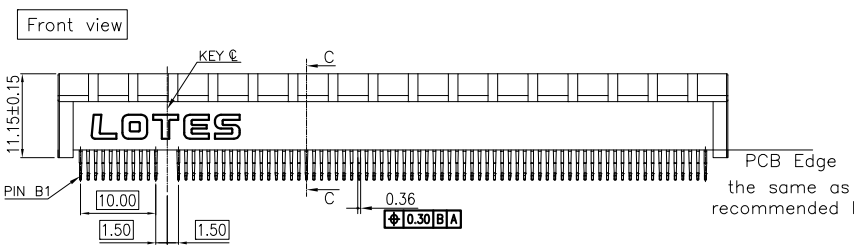

Side view

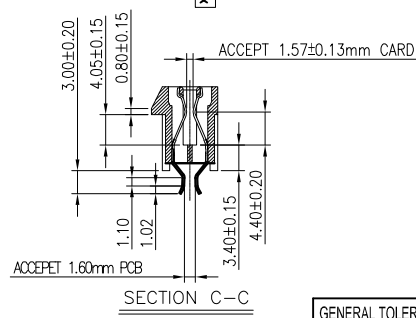
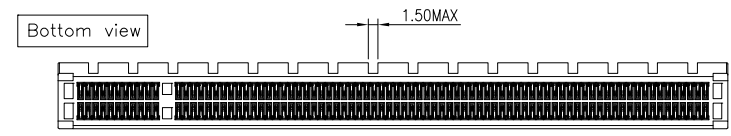

SECTION C-C

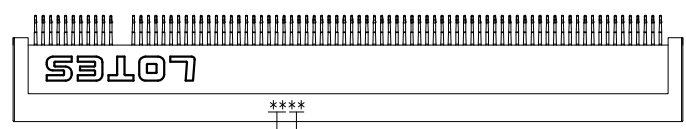
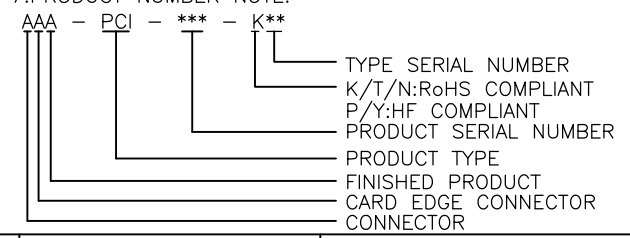

DATE CODE: WEEK YEAR

GENERAL TOLERANCES UNLESS SPECIFIED		PART NO. SEE TABLE	LOTES					
.X± 0.35	X°± 3°					APPROVED BY YINJIAXU 07/27'17	TITLE 164PIN PCI EXPRESS CONNECTOR	
.XX± 0.25	.X°± 2°							
.XXX± 0.15	.XX°± 1°							
CUSTOMER DRAWING		CHECKED BY MARK 07/27'17	DWG NO. GAP-AAA-PCI-014					
SIZE A4	UNITS MM[INCH]	DRAWN BY WUYAO 07/27'17	SHEET 1 / 2	SCALE 1:1	REV 9			

1 2 3 4 5 6 7 8

F
E
D
C
B
A

F
E
D
C
B
A

REV.	ECN NO./DESCRIPTION	DATE
8	N150637	12/10'15
8A	R160606	06/27'17
9	N170379	07/27'17

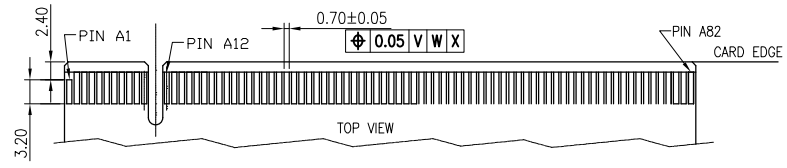
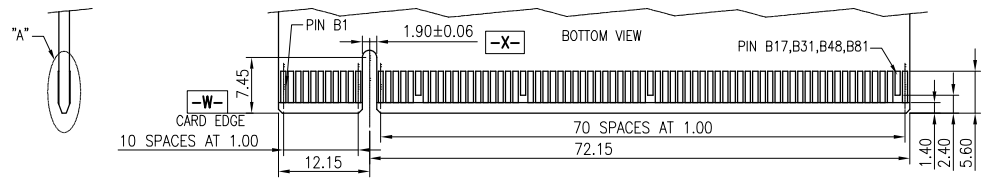

ADD-IN CARD EDGE-FINGER DIMENSIONS
 DEFAULT TOLERANCE ±0.05

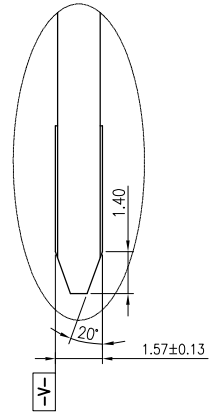

DETAIL "A"
 SCALE 4:1

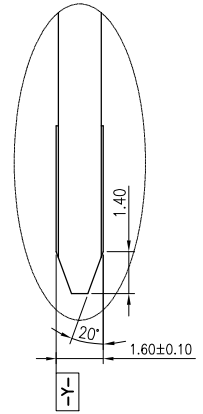

DETAIL "B"
 SCALE 4:1

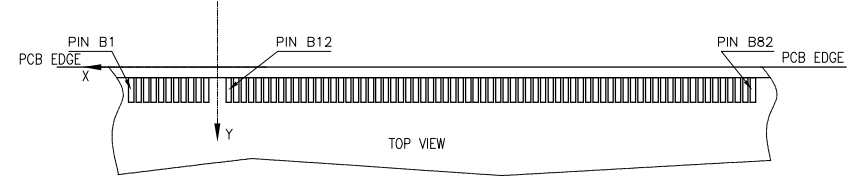
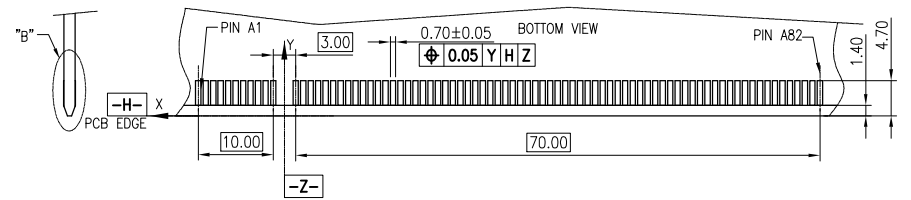

RECOMMENDED FOOTPRINT
 DEFAULT TOLERANCE ±0.05

GENERAL TOLERANCES UNLESS SPECIFIED		PART NO.	LOTES		
X ± 0.35	X° ± 3°	SEE TABLE			
.XX ± 0.25	.X° ± 2°	APPROVED BY	TITLE		
.XXX ± 0.15	.XX° ± 1°	YINJIAXU 07/27'17	164PIN PCI EXPRESS CONNECTOR		
CUSTOMER DRAWING		CHECKED BY	DWG NO.		
		MARK 07/27'17	GAP-AAA-PCI-014		
SIZE	UNITS	DRAWN BY	SHEET	SCALE	REV
A4	MM[INCH]	WUYAO 07/27'17			

NO.	PART NUMBER	HOUSING	TERMINAL
1	AAA-PCI-014-K06	PA9T+30%GF_BLACK;UL94 V-0	PHOSPHOR BRONZE_C5191_G/F
2	AAA-PCI-014-K15	PA9T+30%GF_BLACK;UL94 V-0	PHOSPHOR BRONZE_C5191_G/F

X-ON Electronics

Largest Supplier of Electrical and Electronic Components

Click to view similar products for [Standard Card Edge Connectors](#) category:

Click to view products by [LOTES](#) manufacturer:

Other Similar products are found below :

[CR7E-30DB-3.96E\(72\)](#) [6565204-6](#) [1437274-4](#) [EBT15622B2X](#) [1-582587-1](#) [284-0102-12100](#) [286-0052-12101A](#) [306022901000000](#) [307-012-502-202](#) [307-056-520-300](#) [A6D22DS29C2](#) [1926088-2](#) [287-0032-12101](#) [345-060-559-303](#) [392-008-559-201](#) [534671-1](#) [341-240-317](#) [345-044-500-300](#) [346-240-318](#) [387-012-523-300](#) [395-100-524-300](#) [09-07-2032](#) [10035388-802LF](#) [10115859-011LF](#) [10122859-009LF](#) [101269333204245CLF](#) [530555-1](#) [66925-516LF](#) [5145409-2](#) [73726-0005](#) [66308-1](#) [5036A30](#) [PEC-07-02-T-S-A](#) [346-014-520-801](#) [KSLX-62-BR](#) [307-048-502-202](#) [CE100F26-7-C](#) [CE100F28-3-D](#) [CE100F28-4-D](#) [CE156F18-9-C](#) [CE156F22-5-D](#) [CE156F22-9-C](#) [CT100F22-2-D](#) [CT100F22-3-D](#) [CT100F24-2-D](#) [CT100F24-3-D](#) [CT100F24-6-C](#) [CT156F22-4-D](#) [MLSS100-12-C](#) [MLSS100-16-C](#)