

- Dimensions compatible to EN/BS 50047
- Direct opening action of NC contacts
- Extensive range of operating heads
- Versions complete with interchangeable and rotatable heads
- Versions with removable and interchangeable auxiliary contact blocks.

	SEC. - PAGE
Metal and plastic limit switches, K series (dimensions to/compatible to EN/BS 50047)	
Top push rod plunger	9 - 2
Top roller push plunger	9 - 3
Roller centre push lever	9 - 4
Roller side push lever	9 - 5
Roller lever	9 - 6
Adjustable roller lever	9 - 8
Ceramic rod lever	9 - 10
Adjustable rod lever	9 - 11
Wobble stick, omnidirectional	9 - 12
Hinge operating	9 - 13
Slotted lever	9 - 14
Key operated	9 - 15
Accessories and spare parts	9 - 16
Prewired metal limit switches	9 - 18
Metal limit switches, PL series	
Top push rod plunger, top roller push plunger, roller centre push lever	9 - 19
Latch and manual release	9 - 20
Manual reload and magnetic release	9 - 20
Bi-directional	9 - 20
Rope-pull lever limit switches for normal stopping	9 - 21
Rope-pull lever limit switches for emergency stopping (ISO 13850 compliant)	9 - 23
Safety switches with solenoid and separate actuator	9 - 24
Plastic micro switches	9 - 26
Foot switches	9 - 27
Dimensions	9 - 28
Wiring diagrams	9 - 35



Page 9-2

PLASTIC AND METAL LIMIT SWITCHES K SERIES

- Dimensions to EN/BS 50047 standards for KB and KM types
- Dimensions compatible to EN/BS 50047 for KC and KN types
- Self-extinguishing polymer thermoplastic housing (KB-KC types)
- Aluminium-zinc alloy housing (KM-KN types)
- Removable and interchangeable auxiliary contact blocks
- Bi-directional versions
- Unique fixing mechanism of operating head
- IEC degree of protection IP65
- M20 cable entry; PG13.5 or 1/2 NPT entry available.



Page 9-18

PREWIRED METAL LIMIT SWITCHES

- Dimensions to EN/BS 50047 standards
- 2 metre long cable
- IEC degree of protection IP67.



Page 9-19

METAL LIMIT SWITCHES PL SERIES

- Aluminium-zinc alloy housing
- Maximum of 2 auxiliary contacts
- IEC degree of protection IP40 and IP65
- PG11 cable entry.



Page 9-21

ROPE-PULL LEVER LIMIT SWITCHES FOR NORMAL STOPPING

- Self-extinguishing polymer thermoplastic housing
- Aluminium-zinc alloy housing
- IEC degree of protection IP40, IP65 and IP66
- PG11 and PG13.5 cable entry.



Page 9-23

ROPE-PULL LEVER LIMIT SWITCHES FOR EMERGENCY STOPPING

- Compliant to ISO 13850 standards
- IEC degree of protection IP65 and IP66
- PG11 and PG13.5 cable entry.



Page 9-24

SAFETY SWITCHES WITH SOLENOID AND SEPARATE ACTUATOR

- Actuator locked by solenoid
- For safety applications up to:
 - Safety integrity level (SIL), category 3: according to EN/BS 62061
 - PLe according to EN/BS ISO 13849-1
- Interlock with mechanical lock Type 2 according to EN/BS ISO 14119
- Self-extinguishing polymer thermoplastic housing and actuator head
- IEC degree of protection IP65
- Three threaded conduit entries M20.



Page 9-26

PLASTIC MICRO SWITCHES

- Polymer thermoplastic housing
- Changeover contact switch
- IEC degree of protection IP00 or IP20.



Page 9-27

FOOT SWITCHES

- Versions with or without protection cover
- Self-extinguishing polymer thermoplastic housing
- Aluminium-zinc alloy housing
- IEC degree of protection IP54 and IP65
- M20 cable entry.

9 Limit, micro and foot switches

Limit switches, K series. One bottom cable entry. Dimensions to EN/BS 50047
Two side cable entries. Dimensions compatible to EN/BS 50047

Top push rod plunger



KBA... - KMA...

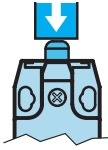

KCA... - KNA...

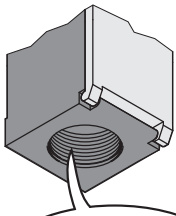

M20 CABLE ENTRY

For types with PG13.5 cable entry, add the letter P at the end of the order code while for 1/2 NPT, add N. E.g. KBA1S11P - KBA1S11N

Order code Plastic body	Metal body	Contacts	Plunger material	Qty per pkg n°	Wt [kg]
One bottom cable entry. Dimensions to EN/BS 50047.					
KBA1S11	KMA1S11	1NO+1NC Snap actionⓁ	Metal	5	Ⓛ
KBA1S02	KMA1S02	2NC Snap actionⓁ	Metal	5	Ⓛ
KBA1A11	KMA1A11	1NO+1NC Slow action make before breakⓁ	Metal	5	Ⓛ
KBA1L11	KMA1L11	1NO+1NC Slow actionⓁ	Metal	5	Ⓛ
KBA1L02	KMA1L02	2NC Slow actionⓁ	Metal	5	Ⓛ
KBA1L20	KMA1L20	2NO Slow action	Metal	5	Ⓛ
KBA1L12	KMA1L12	1NO+2NC Slow actionⓁ	Metal	5	Ⓛ
KBA1L21	KMA1L21	2NO+1NC Slow actionⓁ	Metal	5	Ⓛ
KBA1L03	KMA1L03	3NC Slow actionⓁ	Metal	5	Ⓛ

Two side cable entries. Dimensions compatible to EN/BS 50047.

KCA1S11	KNA1S11	1NO+1NC Snap actionⓁ	Metal	5	Ⓛ
KCA1S02	KNA1S02	2NC Snap actionⓁ	Metal	5	Ⓛ
KCA1A11	KNA1A11	1NO+1NC Slow action make before breakⓁ	Metal	5	Ⓛ
KCA1L11	KNA1L11	1NO+1NC Slow actionⓁ	Metal	5	Ⓛ
KCA1L02	KNA1L02	2NC Slow actionⓁ	Metal	5	Ⓛ
KCA1L20	KNA1L20	2NO Slow action	Metal	5	Ⓛ

Ⓛ Direct (positive) opening action Ⓜ; safety function according to IEC/EN/BS 60947-5-1.

Ⓜ Consult Technical support for information; see contact details on inside cover.

General characteristics

The LOVATO Electric limit switches have been designed to satisfy requirements comprising quick installation, easy wiring, simple setup, modularity, sturdiness and constant reliability.

The body cover is hinged at the bottom and removable. The innovative locking bayonet mechanism permits to remove and reposition the operating head in the required configuration with no tools. The auxiliary contact blocks are removable assuring remarkable wiring ease.

Operational characteristics

- Maximum operating rate: 3600 cycles/h
- Switching speed: 0.5...1.5m/s
- Mechanical life: >10 million cycles
- IEC conventional thermal current Ith: 10A
- UL/CSA and IEC/EN/BS 60947-5-1 designation:
 - A600 Q300 for KB...-KC... types
 - A300 Q300 for KM...-KN... types
- IEC rated insulation voltage Ui:
 - 690VAC for KB...-KC... types
 - 440VAC for KM...-KN... types
- IEC rated impulse withstand voltage Uimp:
 - 6kV for KB...-KC... types
 - 4kV for KM...-KN... types
- Class II insulation for KB...-KC... only
- Contact resistance: <10mΩ
- Short-circuit backup protection: 10A gG/SC quick fuse
- Operators of aluminium-zinc alloy
- Housing:
 - KB...-KC... types: self-extinguishing double-insulation polymer thermoplastic
 - KM...-KN... types: aluminium-zinc alloy
- Cable entry: M20 standard supplied; PG13.5 and 1/2 NPT available (see the side note for details)
- Operating head fixing: locking bayonet insert
- Operating force: 5N / 1.1lb
- Cable connection: self-releasing screw terminal
- Tightening torque:
 - Switch fixing: 2.5Nm / 22.1lb.in
 - Contact terminals: 0.8Nm / 7lb.in
 - Body lid screw fixing: 0.8Nm / 7lb.in
- Conductor section: 1 or 2 2.5mm² max / 16-14AWG
- Ambient conditions:
 - Operating temperature: -25...+70°C
 - Storage temperature: -40...+70°C
 - Pollution degree: 3
 - IEC degree of protection: IP20 for terminals
 - IEC degree of protection: IP65 for body housing.

Certifications and compliance

Certifications obtained: UL Listed for USA and Canada (cULus - File E93601), as Auxiliary Devices - Limit switches; EAC, CCC.

Compliant with standards: EN/BS 50047, IEC/EN/BS 60947-1, IEC/EN/BS 60947-5-1, IEC/EN/BS 60204-1, UL508, CSA C22.2 n° 14.

- ▶ Forward travel of snap action contacts
- ◀ Return travel of snap action contacts

□ open
■ closed

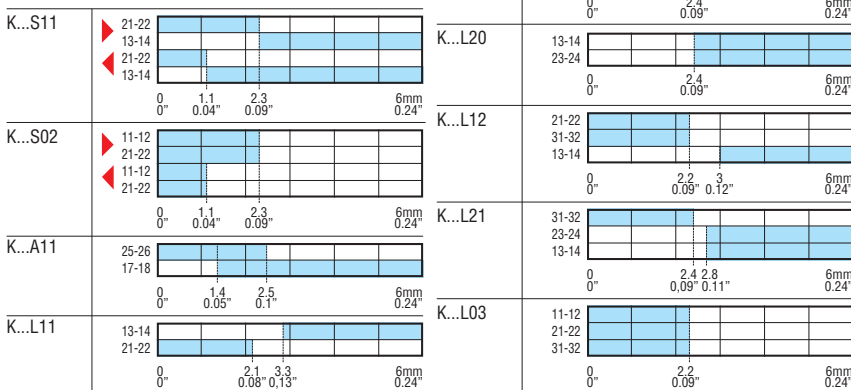

9 Limit, micro and foot switches

Limit switches, K series. One bottom cable entry. Dimensions to EN/BS 50047
Two side cable entries. Dimensions compatible to EN/BS 50047

Top roller push plunger



KBB... - KMB...

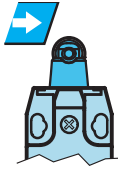

KCB... - KNB...

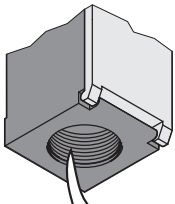

M20 CABLE ENTRY

For types with PG13.5 cable entry, add the letter P at the end of the order code while for 1/2 NPT, add N. E.g. KBB1S11P - KBB1S11N

Order code Plastic body	Order code Metal body	Contacts	Roller material	Qty per pkg	Wt [kg]
			Ø11x4	n°	[kg]

One bottom cable entry. Dimensions to EN/BS 50047.

KBB1S11	KMB1S11	1NO+1NC	Plastic	5	⊕
KBB2S11	KMB2S11	Snap action⊕	Metal	5	⊕
KBB1S02	KMB1S02	2NC	Plastic	5	⊕
KBB2S02	KMB2S02	Snap action⊕	Metal	5	⊕
KBB1A11	KMB1A11	1NO+1NC	Plastic	5	⊕
KBB2A11	KMB2A11	Slow action make before break⊕	Metal	5	⊕
KBB1L11	KMB1L11	1NO+1NC	Plastic	5	⊕
KBB2L11	KMB2L11	Slow action⊕	Metal	5	⊕
KBB1L02	KMB1L02	2NC	Plastic	5	⊕
KBB2L02	KMB2L02	Slow action⊕	Metal	5	⊕
KBB1L20	KMB1L20	2NO	Plastic	5	⊕
KBB2L20	KMB2L20	Slow action	Metal	5	⊕
KBB1L12	KMB1L12	1NO+2NC	Plastic	5	⊕
KBB2L12	KMB2L12	Slow action⊕	Metal	5	⊕
KBB1L21	KMB1L21	2NO+1NC	Plastic	5	⊕
KBB2L21	KMB2L21	Slow action⊕	Metal	5	⊕
KBB1L03	KMB1L03	3NC	Plastic	5	⊕
KBB2L03	KMB2L03	Slow action⊕	Metal	5	⊕

Two side cable entries. Dimensions compatible to EN/BS 50047.

KCB1S11	KNB1S11	1NO+1NC	Plastic	5	⊕
KCB2S11	KNB2S11	Snap action⊕	Metal	5	⊕
KCB1S02	KNB1S02	2NC	Plastic	5	⊕
KCB2S02	KNB2S02	Snap action⊕	Metal	5	⊕
KCB1A11	KNB1A11	1NO+1NC	Plastic	5	⊕
KCB2A11	KNB2A11	Slow action make before break⊕	Metal	5	⊕
KCB1L11	KNB1L11	1NO+1NC	Plastic	5	⊕
KCB2L11	KNB2L11	Slow action⊕	Metal	5	⊕
KCB1L02	KNB1L02	2NC	Plastic	5	⊕
KCB2L02	KNB2L02	Slow action⊕	Metal	5	⊕
KCB1L20	KNB1L20	2NO	Plastic	5	⊕
KCB2L20	KNB2L20	Slow action	Metal	5	⊕

⊕ Direct (positive) opening action ⊖; safety function according to IEC/EN/BS 60947-5-1.

⊕ Consult Technical support for information; see contact details on inside cover.

Ø11x4mm = Ø0.43x0.16".

General characteristics

The LOVATO Electric limit switches have been designed to satisfy requirements comprising quick installation, easy wiring, simple setup, modularity, sturdiness and constant reliability.

The body cover is hinged at the bottom and removable.

The innovative locking bayonet mechanism permits to remove and reposition the operating head in the required configuration with no tools. The heads have axial rotation of 45° angles.

The auxiliary contact blocks are removable assuring remarkable wiring ease.

Operational characteristics

- Maximum operating rate: 3600 cycles/h
- Switching speed: 0.5...1.5m/s
- Mechanical life: >10 million cycles
- IEC conventional thermal current Ith: 10A
- UL/CSA and IEC/EN/BS 60947-5-1 designation:
 - A600 Q300 for KB...-KC... types
 - A300 Q300 for KM...-KN... types
- IEC rated insulation voltage Ui:
 - 690VAC for KB...-KC... types
 - 440VAC for KM...-KN... types
- IEC rated impulse withstand voltage Uimp:
 - 6kV for KB...-KC... types
 - 4kV for KM...-KN... types
- Class II insulation for KB...-KC... only
- Contact resistance: <10mΩ
- Short-circuit backup protection: 10A gG/SC quick fuse
- Operators of aluminium-zinc alloy
- Housing:
 - KB...-KC... types: self-extinguishing double-insulation polymer thermoplastic
 - KM...-KN... types: aluminium-zinc alloy
- Cable entry: M20 standard supplied; PG13.5 and 1/2 NPT available (see the side note for details)
- Operating head fixing: locking bayonet insert
- Operating force: 5N / 1.1lb
- Cable connection: self-releasing screw terminal
- Tightening torque:
 - Switch fixing: 2.5Nm / 22.1lb.in
 - Contact terminals: 0.8Nm / 7lb.in
 - Body lid screw fixing: 0.8Nm / 7lb.in
- Conductor section: 1 or 2 2.5mm² max / 16-14AWG
- Ambient conditions:
 - Operating temperature: -25...+70°C
 - Storage temperature: -40...+70°C
 - Pollution degree: 3
 - IEC degree of protection: IP20 for terminals
 - IEC degree of protection: IP65 for body housing.

Certifications and compliance

Certifications obtained: UL Listed for USA and Canada (cULus - File E93601), as Auxiliary Devices - Limit switches; EAC, CCC.

Compliant with standards: EN/BS 50047, IEC/EN/BS 60947-1, IEC/EN/BS 60947-5-1, IEC/EN/BS 60204-1, UL508, CSA C22.2 n° 14.

- ▶ Forward travel of snap action contacts
- ◀ Return travel of snap action contacts

□ open

■ closed

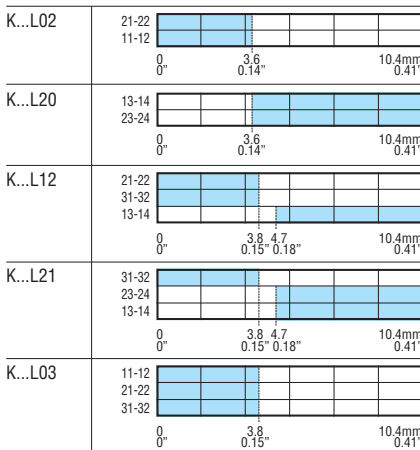
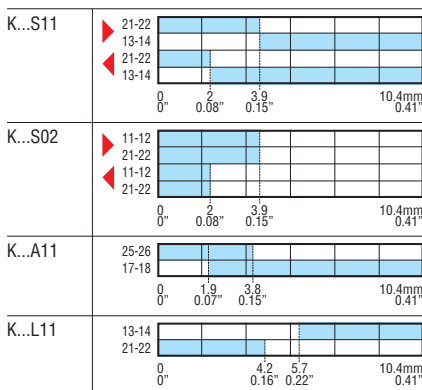

9 Limit, micro and foot switches

Limit switches, K series. One bottom cable entry. Dimensions to EN/BS 50047
Two side cable entries. Dimensions compatible to EN/BS 50047

Roller centre push lever



KBC... - KMC...

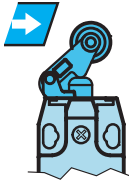

KCC... - KNC...

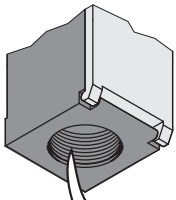

M20 CABLE ENTRY

For types with PG13.5 cable entry, add the letter P at the end of the order code while for 1/2 NPT, add N. E.g. KBC1S11P - KBC1S11N

Order code Plastic body	Metal body	Contacts	Roller material	Qty per pkg n°	Wt [kg]
-------------------------	------------	----------	-----------------	----------------	---------

One bottom cable entry. Dimensions to EN/BS 50047.

KBC1S11	KMC1S11	1NO+1NC	Plastic	5	⊕
KBC2S11	KMC2S11	Snap actionⓈ	Metal	5	⊕
KBC1S02	KMC1S02	2NC	Plastic	5	⊕
KBC2S02	KMC2S02	Snap actionⓈ	Metal	5	⊕
KBC1A11	KMC1A11	1NO+1NC	Plastic	5	⊕
KBC2A11	KMC2A11	Slow action make before breakⓈ	Metal	5	⊕
KBC1L11	KMC1L11	1NO+1NC	Plastic	5	⊕
KBC2L11	KMC2L11	Slow actionⓈ	Metal	5	⊕
KBC1L02	KMC1L02	2NC	Plastic	5	⊕
KBC2L02	KMC2L02	Slow actionⓈ	Metal	5	⊕
KBC1L20	KMC1L20	2NO	Plastic	5	⊕
KBC2L20	KMC2L20	Slow action	Metal	5	⊕
KBC1L12	KMC1L12	1NO+2NC	Plastic	5	⊕
KBC2L12	KMC2L12	Slow actionⓈ	Metal	5	⊕
KBC1L21	KMC1L21	2NO+1NC	Plastic	5	⊕
KBC2L21	KMC2L21	Slow actionⓈ	Metal	5	⊕
KBC1L03	KMC1L03	3NC	Plastic	5	⊕
KBC2L03	KMC2L03	Slow actionⓈ	Metal	5	⊕

Two side cable entries. Dimensions compatible to EN/BS 50047.

KCC1S11	KNC1S11	1NO+1NC	Plastic	5	⊕
KCC2S11	KNC2S11	Snap actionⓈ	Metal	5	⊕
KCC1S02	KNC1S02	2NC	Plastic	5	⊕
KCC2S02	KNC2S02	Snap actionⓈ	Metal	5	⊕
KCC1A11	KNC1A11	1NO+1NC	Plastic	5	⊕
KCC2A11	KNC2A11	Slow action make before breakⓈ	Metal	5	⊕
KCC1L11	KNC1L11	1NO+1NC	Plastic	5	⊕
KCC2L11	KNC2L11	Slow actionⓈ	Metal	5	⊕
KCC1L02	KNC1L02	2NC	Plastic	5	⊕
KCC2L02	KNC2L02	Slow actionⓈ	Metal	5	⊕
KCC1L20	KNC1L20	2NO	Plastic	5	⊕
KCC2L20	KNC2L20	Slow action	Metal	5	⊕

Ⓢ Direct (positive) opening action ⊕ safety function according to IEC/EN/BS 60947-5-1.

⊕ Consult Technical support for information; see contact details on inside cover.

Ø14x5mm = Ø0.55x0.2".

General characteristics

The LOVATO Electric limit switches have been designed to satisfy requirements comprising quick installation, easy wiring, simple setup, modularity, sturdiness and constant reliability.

The body cover is hinged at the bottom and removable.

The innovative locking bayonet mechanism permits to remove and reposition the operating head in the required configuration with no tools. The heads have axial rotation of 45° angles.

The auxiliary contact blocks are removable assuring remarkable wiring ease.

Operational characteristics

- Maximum operating rate: 3600 cycles/h
- Switching speed: 0.5...1.5m/s
- Mechanical life: >10 million cycles
- IEC conventional thermal current Ith: 10A
- UL/CSA and IEC/EN/BS 60947-5-1 designation:
 - A600 Q300 for KB...-KC... types
 - A300 Q300 for KM...-KN... types
- IEC rated insulation voltage Ui:
 - 690VAC for KB...-KC... types
 - 440VAC for KM...-KN... types
- IEC rated impulse withstand voltage Uimp:
 - 6kV for KB...-KC... types
 - 4kV for KM...-KN... types
- Class II insulation for KB...-KC... only
- Contact resistance: <10mΩ
- Short-circuit backup protection: 10A gG/SC quick fuse
- Operators of aluminium-zinc alloy
- Housing:
 - KB...-KC... types: self-extinguishing double-insulation polymer thermoplastic
 - KM...-KN... types: aluminium-zinc alloy
- Cable entry: M20 standard supplied; PG13.5 and 1/2 NPT available (see the side note for details)
- Operating head fixing: locking bayonet insert
- Operating force: 6N / 1.34lb
- Cable connection: self-releasing screw terminal
- Tightening torque:
 - Switch fixing: 2.5Nm / 22.1lb.in
 - Contact terminals: 0.8Nm / 7lb.in
 - Body lid screw fixing: 0.8Nm / 7lb.in
- Conductor section: 1 or 2 2.5mm² max / 16-14AWG
- Ambient conditions:
 - Operating temperature: -25...+70°C
 - Storage temperature: -40...+70°C
 - Pollution degree: 3
 - IEC degree of protection: IP20 for terminals
 - IEC degree of protection: IP65 for body housing.

Certifications and compliance

Certifications obtained: UL Listed for USA and Canada (cULus - File E93601), as Auxiliary Devices - Limit switches; EAC, CCC.

Compliant with standards: EN/BS 50047, IEC/EN/BS 60947-1, IEC/EN/BS 60947-5-1, IEC/EN/BS 60204-1, UL508, CSA C22.2 n° 14.

- ▶ Forward travel of snap action contacts
- ◀ Return travel of snap action contacts

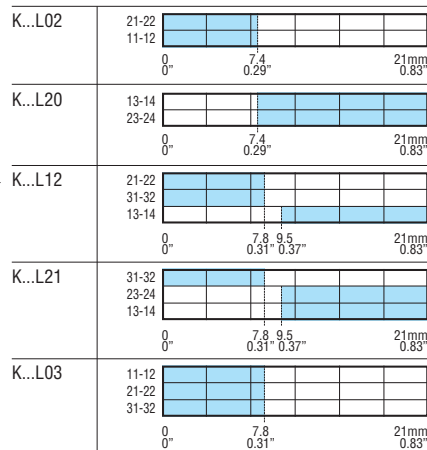
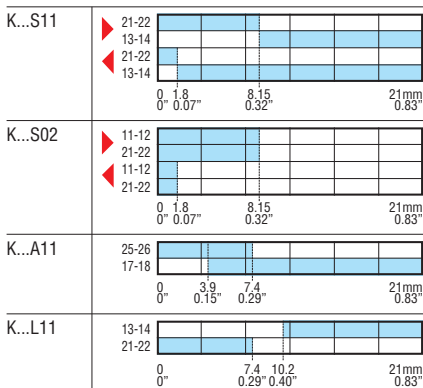

9 Limit, micro and foot switches

Limit switches, K series. One bottom cable entry. Dimensions to EN/BS 50047
Two side cable entries. Dimensions compatible to EN/BS 50047

Roller side push lever

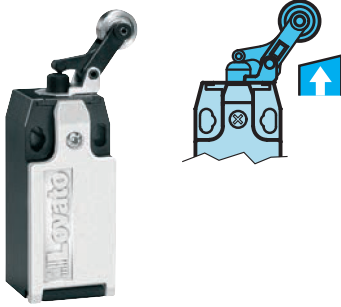

KBD... - KMD...



KCD... - KND...

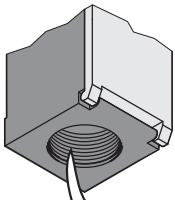

M20 CABLE ENTRY

For types with PG13.5 cable entry, add the letter P at the end of the order code while for 1/2 NPT, add N. E.g. KBD1S11P - KBD1S11N

Order code Plastic body	Order code Metal body	Contacts	Roller material	Qty per pkg	Wt [kg]
			Ø14x5	n°	[kg]

One bottom cable entry. Dimensions to EN/BS 50047.

KBD1S11	KMD1S11	1NO+1NC	Plastic	5	⊕
KBD2S11	KMD2S11	Snap action ⊕	Metal	5	⊕
KBD1S02	KMD1S02	2NC	Plastic	5	⊕
KBD2S02	KMD2S02	Snap action ⊕	Metal	5	⊕
KBD1A11	KMD1A11	1NO+1NC	Plastic	5	⊕
KBD2A11	KMD2A11	Slow action make before break ⊕	Metal	5	⊕
KBD1L11	KMD1L11	1NO+1NC	Plastic	5	⊕
KBD2L11	KMD2L11	Slow action ⊕	Metal	5	⊕
KBD1L02	KMD1L02	2NC	Plastic	5	⊕
KBD2L02	KMD2L02	Slow action ⊕	Metal	5	⊕
KBD1L20	KMD1L20	2NO	Plastic	5	⊕
KBD2L20	KMD2L20	Slow action	Metal	5	⊕
KBD1L12	KMD1L12	1NO+2NC	Plastic	5	⊕
KBD2L12	KMD2L12	Slow action ⊕	Metal	5	⊕
KBD1L21	KMD1L21	2NO+1NC	Plastic	5	⊕
KBD2L21	KMD2L21	Slow action ⊕	Metal	5	⊕
KBD1L03	KMD1L03	3NC	Plastic	5	⊕
KBD2L03	KMD2L03	Slow action ⊕	Metal	5	⊕

Two side cable entries. Dimensions compatible to EN/BS 50047.

KCD1S11	KND1S11	1NO+1NC	Plastic	5	⊕
KCD2S11	KND2S11	Snap action ⊕	Metal	5	⊕
KCD1S02	KND1S02	2NC	Plastic	5	⊕
KCD2S02	KND2S02	Snap action ⊕	Metal	5	⊕
KCD1A11	KND1A11	1NO+1NC	Plastic	5	⊕
KCD2A11	KND2A11	Slow action make before break ⊕	Metal	5	⊕
KCD1L11	KND1L11	1NO+1NC	Plastic	5	⊕
KCD2L11	KND2L11	Slow action ⊕	Metal	5	⊕
KCD1L02	KND1L02	2NC	Plastic	5	⊕
KCD2L02	KND2L02	Slow action ⊕	Metal	5	⊕
KCD1L20	KND1L20	2NO	Plastic	5	⊕
KCD2L20	KND2L20	Slow action	Metal	5	⊕

⊕ Direct (positive) opening action ⊖ safety function according to IEC/EN/BS 60947-5-1.

⊕ Consult Technical support for information; see contact details on inside cover.

Ø14x5mm = Ø0.55x0.2".

General characteristics

The LOVATO Electric limit switches have been designed to satisfy requirements comprising quick installation, easy wiring, simple setup, modularity, sturdiness and constant reliability.

The body cover is hinged at the bottom and removable. The innovative locking bayonet mechanism permits to remove and reposition the operating head in the required configuration with no tools. The heads have axial rotation of 45° angles.

The auxiliary contact blocks are removable assuring remarkable wiring ease.

Operational characteristics

- Maximum operating rate: 3600 cycles/h
- Switching speed: 0.5...1.5m/s
- Mechanical life: >10 million cycles
- IEC conventional thermal current Ith: 10A
- UL/CSA and IEC/EN/BS 60947-5-1 designation:
 - A600 Q300 for KB...-KC... types
 - A300 Q300 for KM...-KN... types
- IEC rated insulation voltage Ui:
 - 690VAC for KB...-KC... types
 - 440VAC for KM...-KN... types
- IEC rated impulse withstand voltage Uimp:
 - 6kV for KB...-KC... types
 - 4kV for KM...-KN... types
- Class II insulation for KB...-KC... only
- Contact resistance: <10mΩ
- Short-circuit backup protection: 10A gG/SC quick fuse
- Operators of aluminium-zinc alloy
- Housing:
 - KB...-KC... types: self-extinguishing double-insulation polymer thermoplastic
 - KM...-KN... types: aluminium-zinc alloy
- Cable entry: M20 standard supplied; PG13.5 and 1/2 NPT available (see the side note for details)
- Operating head fixing: locking bayonet insert
- Operating force: 6N / 1.34lb
- Cable connection: self-releasing screw terminal
- Tightening torque:
 - Switch fixing: 2.5Nm / 22.1lb.in
 - Contact terminals: 0.8Nm / 7lb.in
 - Body lid screw fixing: 0.8Nm / 7lb.in
- Conductor section: 1 or 2 2.5mm² max / 16-14AWG
- Ambient conditions:
 - Operating temperature: -25...+70°C
 - Storage temperature: -40...+70°C
 - Pollution degree: 3
 - IEC degree of protection: IP20 for terminals
 - IEC degree of protection: IP65 for body housing.

Certifications and compliance

Certifications obtained: UL Listed for USA and Canada (cULus - File E93601), as Auxiliary Devices - Limit switches; EAC, CCC.

Compliant with standards: EN/BS 50047, IEC/EN/BS 60947-1, IEC/EN/BS 60947-5-1, IEC/EN/BS 60204-1, UL508, CSA C22.2 n° 14.

- ▶ Forward travel of snap action contacts
- ◀ Return travel of snap action contacts
- open
- closed

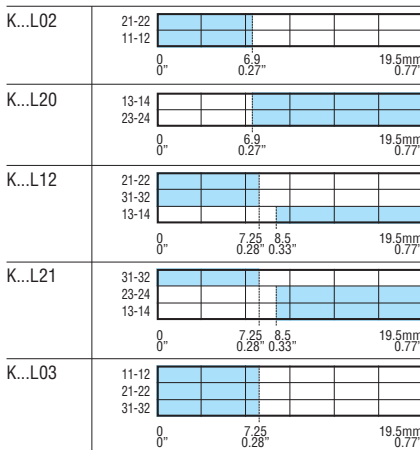
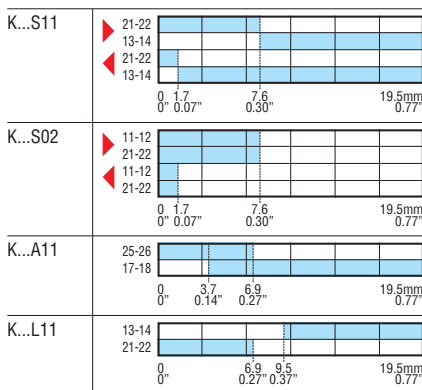

9 Limit, micro and foot switches

Limit switches, K series.

One bottom cable entry. Dimensions to EN/BS 50047

Roller lever plunger



KBE1... - KBE2...
KME1... - KME2...

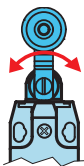

KBE3... - KME3...

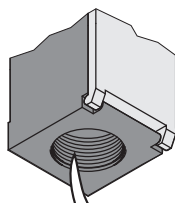

M20 CABLE ENTRY

For types with PG13.5 cable entry, add the letter P at the end of the order code while for 1/2 NPT, add N. E.g. KBE1S11P - KBE1S11N

Order code Plastic body	Order code Metal body	Contacts	Roller material	Qty per pkg	Wt [kg]
One bottom cable entry. Dimensions to EN/BS 50047.					
KBE1S11	KME1S11	1NO+1NC	Plastic ①	5	④
KBE2S11	KME2S11	Snap action ③	Metal ①	5	④
KBE3S11	KME3S11		Rubber ②	5	④
KBE1S02	KME1S02	2NC	Plastic ①	5	④
KBE2S02	KME2S02	Snap action ③	Metal ①	5	④
KBE3S02	KME3S02		Rubber	5	④
KBE1A11	KME1A11	1NO+1NC	Plastic ①	5	④
KBE2A11	KME2A11	Slow action make before break ⑥	Metal ①	5	④
KBE3A11	KME3A11		Rubber ②	5	④
KBE1L11	KME1L11	1NO+1NC	Plastic ①	5	④
KBE2L11	KME2L11	Slow action ③	Metal ①	5	④
KBE3L11	KME3L11		Rubber ②	5	④
KBE1L02	KME1L02	2NC	Plastic ①	5	④
KBE2L02	KME2L02	Slow action ③	Metal ①	5	④
KBE3L02	KME3L02		Rubber ②	5	④
KBE1L20	KME1L20	2NO	Plastic ①	5	④
KBE2L20	KME2L20	Slow action	Metal ①	5	④
KBE3L20	KME3L20		Rubber ②	5	④
KBE1L12	KME1L12	1NO+2NC	Plastic ①	5	④
KBE2L12	KME2L12	Slow action ③	Metal ①	5	④
KBE3L12	KME3L12		Rubber ②	5	④
KBE1L21	KME1L21	2NO+1NC	Plastic ①	5	④
KBE2L21	KME2L21	Slow action ③	Metal ①	5	④
KBE3L21	KME3L21		Rubber ②	5	④
KBE1L03	KME1L03	3NC	Plastic ①	5	④
KBE2L03	KME2L03	Slow action ③	Metal ①	5	④
KBE3L03	KME3L03		Rubber ②	5	④

BI-DIRECTIONAL.

One bottom cable entry. Dimensions to EN/BS 50047.

Order code Plastic body	Order code Metal body	Contacts	Roller material	Qty per pkg	Wt [kg]
KBE1D02	KME1D02	2NC ③ independent	Plastic ①	5	⑤

① Ø19x5mm = Ø0.75x0.2"

② Ø50x10mm = Ø1.97"x0.39"

③ Direct (positive) opening action ⊖; safety function according to IEC/EN/BS 60947-5-1.

④ Consult Technical support for information; see contact details on inside cover.

General characteristics

The LOVATO Electric limit switches have been designed to satisfy requirements comprising quick installation, easy wiring, simple setup, modularity, sturdiness and constant reliability.

The body cover is hinged at the bottom and removable.

The innovative locking bayonet mechanism permits to remove and reposition the operating head in the required configuration with no tools. The heads have axial rotation of 45° angles.

The auxiliary contact blocks are removable assuring remarkable wiring ease.

Operational characteristics

- Maximum operating rate: 3600 cycles/h
- Switching speed: 0.5...1.5m/s
- Mechanical life: >10 million cycles
- IEC conventional thermal current Ith: 10A
- UL/CSA and IEC/EN/BS 60947-5-1 designation:
 - A600 Q300 for KB... types
 - A300 Q300 for KM... types
- IEC rated insulation voltage Ui:
 - 690V for KB... types
 - 440V for KM... types
- IEC rated impulse withstand voltage Uimp:
 - 6kVAC for KB... types
 - 4kVAC for KM... types
- Class II insulation for KB only
- Contact resistance: <10mΩ
- Short-circuit backup protection: 10A gG/SC quick fuse
- Operators of aluminium-zinc alloy
- Housing:
 - KB... types: self-extinguishing double-insulation polymer thermoplastic
 - KM... types: aluminium-zinc alloy
- Cable entry: M20 standard supplied; PG13.5 and 1/2 NPT available (see the side note for details)
- Operating head fixing: locking bayonet insert
- Operating torque: 3Ncm / 4.25ozin
- Cable connection: self-releasing screw terminal
- Tightening torque:
 - Switch fixing: 2.5Nm / 22.1lb.in
 - Contact terminals: 0.8Nm / 7lb.in
 - Body lid screw fixing: 0.8Nm / 7lb.in
- Conductor section: 1 or 2 2.5mm² max / 16-14AWG
- Ambient conditions:
 - Operating temperature: -25...+70°C
 - Storage temperature: -40...+70°C
 - Pollution degree: 3
 - IEC degree of protection: IP20 for terminals
 - IEC degree of protection: IP65 for body housing.

Certifications and compliance

Certifications obtained: UL Listed for USA and Canada (cULus - File E93601), as Auxiliary Devices - Limit switches; EAC, CCC.

Compliant with standards: EN/BS 50047, IEC/EN/BS 60947-1, IEC/EN/BS 60947-5-1, IEC/EN/BS 60204-1, UL508, CSA C22.2 n° 14.

- ▶ Forward travel of snap action contacts
- ◀ Return travel of snap action contacts

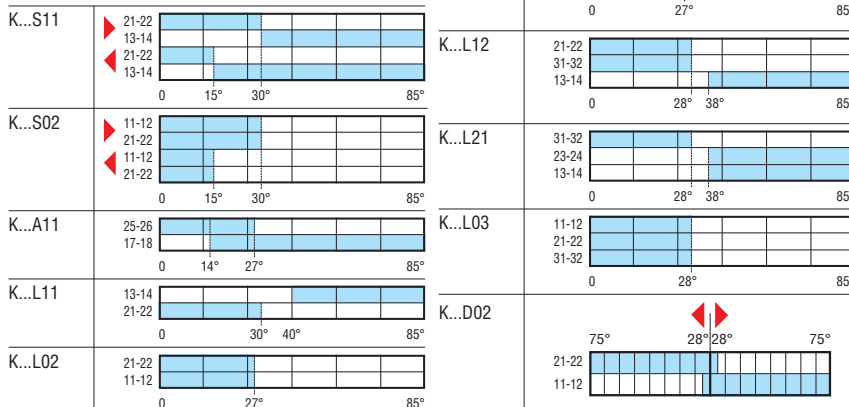

9 Limit, micro and foot switches

Limit switches, K series.

Two side cable entries. Dimensions compatible to EN/BS 50047

Roller lever plunger



KCE1... - KCE2...
KNE1... - KNE2...

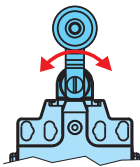

KCE3... - KNE3...

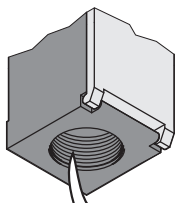

M20 CABLE ENTRY

For types with PG13.5 cable entry, add the letter P at the end of the order code while for 1/2 NPT, add N. E.g. KCE1S11P - KCE1S11N

Order code	Plastic body	Metal body	Contacts	Roller material	Qty per pkg	Wt
					n°	[kg]

Two side cable entries. Dimensions compatible to EN/BS 50047.

KCE1S11	KNE1S11	1NO+1NC	Plastic ①	5	④
KCE2S11	KNE2S11	Snap action ⑤	Metal ①	5	④
KCE3S11	KNE3S11		Rubber ②	5	④
KCE1S02	KNE1S02	2NC	Plastic ①	5	④
KCE2S02	KNE2S02	Snap action ⑤	Metal ①	5	④
KCE3S02	KNE3S02		Rubber	5	④
KCE1A11	KNE1A11	1NO+1NC	Plastic ①	5	④
KCE2A11	KNE2A11	Slow action make before break ⑥	Metal ①	5	④
KCE3A11	KNE3A11		Rubber ②	5	④
KCE1L11	KNE1L11	1NO+1NC	Plastic ①	5	④
KCE2L11	KNE2L11	Slow action ⑥	Metal ①	5	④
KCE3L11	KNE3L11		Rubber ②	5	④
KCE1L02	KNE1L02	2NC	Plastic ①	5	④
KCE2L02	KNE2L02	Slow action ⑥	Metal ①	5	④
KCE3L02	KNE3L02		Rubber ②	5	④
KCE1L20	KNE1L20	2NO	Plastic ①	5	④
KCE2L20	KNE2L20	Slow action	Metal ①	5	④
KCE3L20	KNE3L20		Rubber ②	5	④

BI-DIRECTIONAL.
Two side cable entries. Dimensions compatible to EN/BS 50047.

KCE1D02	KNE1D02	2NC ⑦ independent	Plastic ①	5	④
---------	---------	-------------------	-----------	---	---

- ① Ø19x5mm = Ø0.75"x0.2".
- ② Ø50x10mm = Ø1.97"x0.39".
- ③ Direct (positive) opening action ⊕; safety function according to IEC/EN/BS 60947-5-1.
- ④ Consult Technical support for information; see contact details on inside cover.

General characteristics

The LOVATO Electric limit switches have been designed to satisfy requirements comprising quick installation, easy wiring, simple setup, modularity, sturdiness and constant reliability.

The body cover is hinged at the bottom and removable. The innovative locking bayonet mechanism permits to remove and reposition the operating head in the required configuration with no tools. The heads have axial rotation of 90° angles.

The auxiliary contact blocks are removable assuring remarkable wiring ease.

Operational characteristics

- Maximum operating rate: 3600 cycles/h
- Switching speed: 0.5...1.5m/s
- Mechanical life: >10 million cycles
- IEC conventional thermal current Ith: 10A
- UL/CSA and IEC/EN/BS 60947-5-1 designation:
 - A600 Q300 for KC... types
 - A300 Q300 for KN... types
- IEC rated insulation voltage Ui:
 - 690VAC for KC... types
 - 440VAC for KN... types
- IEC rated impulse withstand voltage Uimp:
 - 6kV for KC... types
 - 4kV for KN... types
- Class II insulation for KC only
- Contact resistance: <10mΩ
- Short-circuit backup protection: 10A gG/SC quick fuse
- Operators of aluminium-zinc alloy
- Housing:
 - KC... types: self-extinguishing double-insulation polymer thermoplastic
 - KN... types: aluminium-zinc alloy
- Cable entry: M20 standard supplied; PG13.5 and 1/2 NPT available (see the side note for details)
- Operating head fixing: locking bayonet insert
- Operating torque: 3Ncm/4.25ozin
- Cable connection: self-releasing screw terminal
- Tightening torque:
 - Switch fixing: 2.5Nm / 22.1lb.in
 - Contact terminals: 0.8Nm / 7lb.in
 - Body lid screw fixing: 0.8Nm / 7lb.in
- Conductor section: 1 or 2 2.5mm² max / 16-14AWG
- Ambient conditions:
 - Operating temperature: -25...+70°C
 - Storage temperature: -40...+70°C
 - Pollution degree: 3
 - IEC degree of protection: IP20 for terminals
 - IEC degree of protection: IP65 for body housing.

Certifications and compliance

Certifications obtained: UL Listed for USA and Canada (cULus - File E93601), as Auxiliary Devices - Limit switches; EAC, CCC.

Compliant with standards: IEC/EN/BS 60947-1, IEC/EN/BS 60947-5-1, IEC/EN/BS 60204-1, UL508, CSA C22.2 n° 14.

- ▶ Forward travel of snap action contacts open
- ◀ Return travel of snap action contacts closed

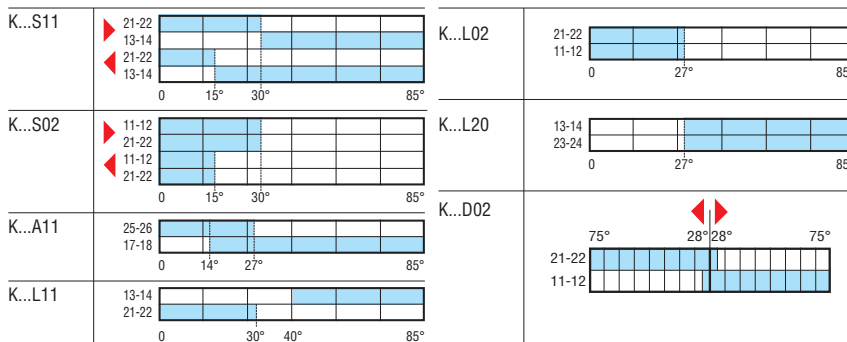

9 Limit, micro and foot switches

Limit switches, K series.

One bottom cable entry. Dimensions to EN/BS 50047

Adjustable roller lever



KB... - KMF...

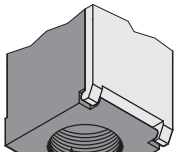
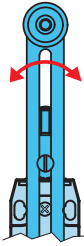

M20 CABLE ENTRY

For types with PG13.5 cable entry, add the letter P at the end of the order code while for 1/2 NPT, add N. E.g. KBF1S11P - KBF1S11N

Order code Plastic body	Metal body	Contacts	Roller material	Qty per pkg n°	Wt [kg]
One bottom cable entry. Dimensions to EN/BS 50047.					
KBF1S11	KMF1S11	1NO+1NC	Plastic ①	5	⑤
KBF2S11	KMF2S11	Snap action ④	Metal ①	5	⑤
KBF3S11	KMF3S11		Rubber ②	5	⑤
KBF4S11	KMF4S11		Rubber ③	5	⑤
KBF1S02	KMF1S02		2NC	Plastic ①	5
KBF2S02	KMF2S02	Snap action ④	Metal ①	5	⑤
KBF3S02	KMF3S02		Rubber ②	5	⑤
KBF4S02	KMF4S02		Rubber ③	5	⑤
KBF1A11	KMF1A11	1NO+1NC	Plastic ①	5	⑤
KBF2A11	KMF2A11	Slow action make before break ④	Metal ①	5	⑤
KBF3A11	KMF3A11		Rubber ②	5	⑤
KBF4A11	KMF4A11		Rubber ③	5	⑤
KBF1L11	KMF1L11		1NO+1NC	Plastic ①	5
KBF2L11	KMF2L11	Slow action ④	Metal ①	5	⑤
KBF3L11	KMF3L11		Rubber ②	5	⑤
KBF4L11	KMF4L11		Rubber ③	5	⑤
KBF1L02	KMF1L02	2NC	Plastic ①	5	⑤
KBF2L02	KMF2L02	Slow action ④	Metal ①	5	⑤
KBF3L02	KMF3L02		Rubber ②	5	⑤
KBF4L02	KMF4L02		Rubber ③	5	⑤
KBF1L20	KMF1L20	2NO	Plastic ①	5	⑤
KBF2L20	KMF2L20	Slow action	Metal ①	5	⑤
KBF3L20	KMF3L20		Rubber ②	5	⑤
KBF4L20	KMF4L20		Rubber ③	5	⑤
KBF1L12	KMF1L12	1NO+2NC	Plastic ①	5	⑤
KBF2L12	KMF2L12	Slow action ④	Metal ①	5	⑤
KBF3L12	KMF3L12		Rubber ②	5	⑤
KBF4L12	KMF4L12		Rubber ③	5	⑤
KBF1L21	KMF1L21		2NO+1NC	Plastic ①	5
KBF2L21	KMF2L21	Slow action ④	Metal ①	5	⑤
KBF3L21	KMF3L21		Rubber ②	5	⑤
KBF4L21	KMF4L21		Rubber ③	5	⑤
KBF1L03	KMF1L03	3NC	Plastic ①	5	⑤
KBF2L03	KMF2L03	Slow action ④	Metal ①	5	⑤
KBF3L03	KMF3L03		Rubber ②	5	⑤
KBF4L03	KMF4L03		Rubber ③	5	⑤

BI-DIRECTIONAL.

One bottom cable entry. Dimensions to EN/BS 50047.

KBF1D02	KMF1D02	2NC ④ independent	Plastic ①	5	⑤
---------	---------	----------------------	-----------	---	---

- ① Ø19x5mm = Ø0.75x0.2".
- ② Ø50x10mm = Ø1.97x0.34".
- ③ Ø50x10mm (Ø1.97x0.35") with offset alignment.
- ④ Direct (positive) opening action ☺; safety function according to IEC/EN/BS 60947-5-1.
- ⑤ Consult Technical support for information; see contact details on inside cover.

- ▶ Forward travel of snap action contacts
- ◀ Return travel of snap action contacts
- open
- closed

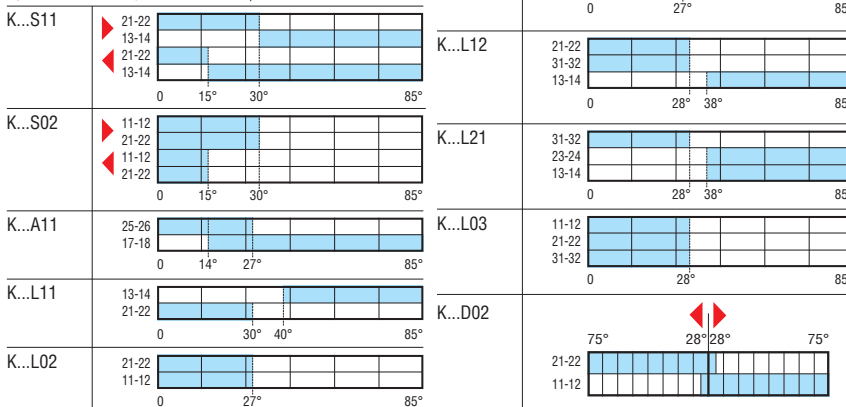

General characteristics

The LOVATO Electric limit switches have been designed to satisfy requirements comprising quick installation, easy wiring, simple setup, modularity, sturdiness and constant reliability.

The body cover is hinged at the bottom and removable.

The innovative locking bayonet mechanism permits to remove and reposition the operating head in the required configuration with no tools. The heads have axial rotation of 180° angles.

The auxiliary contact blocks are removable assuring remarkable wiring ease.

Operational characteristics

- Maximum operating rate: 3600 cycles/h
- Switching speed: 0.5...1.5m/s
- Mechanical life: >10 million cycles
- IEC conventional thermal current Ith: 10A
- UL/CSA and IEC/EN/BS 60947-5-1 designation:
 - A600 Q300 for KB... types
 - A300 Q300 for KM... types
- IEC rated insulation voltage Ui:
 - 690V for KB... types
 - 440V for KM... types
- IEC rated impulse withstand voltage Uimp:
 - 6kVAC for KB... types
 - 4kVAC for KM... types
- Class II insulation for KB only
- Contact resistance: <10mΩ
- Short-circuit backup protection: 10A gG/SC quick fuse
- Operators of aluminium-zinc alloy
- Housing:
 - KB... types: self-extinguishing double-insulation polymer thermoplastic
 - KM... types: aluminium-zinc alloy
- Cable entry: M20 standard supplied; PG13.5 and 1/2 NPT available (see the side note for details)
- Operating head fixing: locking bayonet insert
- Operating force: 3Ncm / 4.25ozin
- Cable connection: self-releasing screw terminal
- Tightening torque:
 - Switch fixing: 2.5Nm / 22.1lb.in
 - Contact terminals: 0.8Nm / 7lb.in
 - Body lid screw fixing: 0.8Nm / 7lb.in
- Conductor section: 1 or 2 2.5mm² max / 16-14AWG
- Ambient conditions:
 - Operating temperature: -25...+70°C
 - Storage temperature: -40...+70°C
 - Pollution degree: 3
 - IEC degree of protection: IP20 for terminals
 - IEC degree of protection: IP65 for body housing.

Certifications and compliance

Certifications obtained: UL Listed for USA and Canada (cULus - File E93601), as Auxiliary Devices - Limit switches; EAC, CCC.

Compliant with standards: EN/BS 50047, IEC/EN/BS 60947-1, IEC/EN/BS 60947-5-1, IEC/EN/BS 60204-1, UL508, CSA C22.2 n° 14.

9 Limit, micro and foot switches

Limit switches, K series.
Two side cable entries. Dimensions compatible to EN/BS 50047

Adjustable roller lever

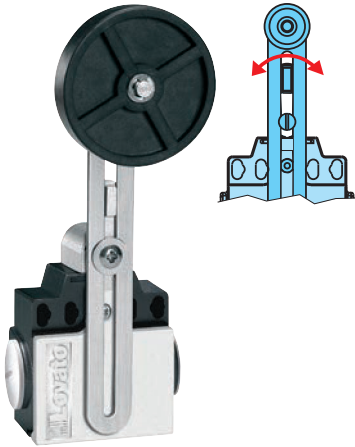

KCF... - KNF...

Order code Plastic body	Metal body	Contacts	Roller material	Qty per pkg	Wt n° [kg]
Two side cable entries. Dimensions compatible to EN/BS 50047.					
KCF1S11	KNF1S11	1NO+1NC Snap action [⊕]	Plastic ^①	5	④
KCF2S11	KNF2S11		Metal ^①	5	④
KCF3S11	KNF3S11		Rubber ^②	5	④
KCF4S11	KNF4S11		Rubber ^② offset align.	5	④
KCF1S02	KNF1S02	2NC Snap action [⊕]	Plastic ^①	5	④
KCF2S02	KNF2S02		Metal ^①	5	④
KCF3S02	KNF3S02		Rubber ^②	5	④
KCF4S02	KNF4S02		Rubber ^② offset align.	5	④
KCF1A11	KNF1A11	1NO+1NC Slow action make before break [⊕]	Plastic ^①	5	④
KCF2A11	KNF2A11		Metal ^①	5	④
KCF3A11	KNF3A11		Rubber ^②	5	④
KCF4A11	KNF4A11		Rubber ^② offset align.	5	④
KCF1L11	KNF1L11	1NO+1NC Slow action [⊕]	Plastic ^①	5	④
KCF2L11	KNF2L11		Metal ^①	5	④
KCF3L11	KNF3L11		Rubber ^②	5	④
KCF4L11	KNF4L11		Rubber ^② offset align.	5	④
KCF1L02	KNF1L02	2NC Slow action [⊕]	Plastic ^①	5	④
KCF2L02	KNF2L02		Metal ^①	5	④
KCF3L02	KNF3L02		Rubber ^②	5	④
KCF4L02	KNF4L02		Rubber ^② offset align.	5	④
KCF1L20	KNF1L20	2NO Slow action	Plastic ^①	5	④
KCF2L20	KNF2L20		Metal ^①	5	④
KCF3L20	KNF3L20		Rubber ^②	5	④
KCF4L20	KNF4L20		Rubber ^② offset align.	5	④

① Ø19x5mm = Ø0.75x0.2".
 ② Ø50x10mm = Ø1.97x0.34".
 ⊕ Direct (positive) opening action ⊖ safety function according to IEC/EN/BS 60947-5-1.
 ④ Consult Technical support for information; see contact details on inside cover.

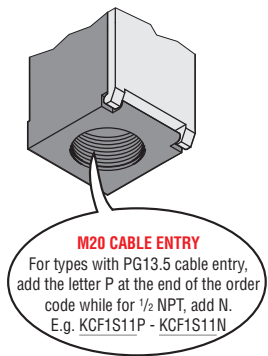

General characteristics

The LOVATO Electric limit switches have been designed to satisfy requirements comprising quick installation, easy wiring, simple setup, modularity, sturdiness and constant reliability.

The body cover is hinged at the bottom and removable. The innovative locking bayonet mechanism permits to remove and reposition the operating head in the required configuration with no tools. The heads have axial rotation of 180° angles.

The auxiliary contact blocks are removable assuring remarkable wiring ease.

Operational characteristics

- Maximum operating rate: 3600 cycles/h
- Switching speed: 0.5...1.5m/s
- Mechanical life: >10 million cycles
- IEC conventional thermal current Ith: 10A
- UL/CSA and IEC/EN/BS 60947-5-1 designation:
 - A600 Q300 for KC... types
 - A300 Q300 for KN... types
- IEC rated insulation voltage Ui:
 - 690VAC for KC... types
 - 440VAC for KN... types
- IEC rated impulse withstand voltage Uimp:
 - 6kV for KC... types
 - 4kV for KN... types
- Class II insulation for KC only
- Contact resistance: <10mΩ
- Short-circuit backup protection: 10A gG/SC quick fuse
- Operators of aluminium-zinc alloy
- Housing:
 - KC... types: self-extinguishing double-insulation polymer thermoplastic
 - KN... types: aluminium-zinc alloy
- Cable entry: M20 standard supplied; PG13.5 and 1/2 NPT available (see the side note for details)
- Operating head fixing: locking bayonet insert
- Operating force: 3Ncm/4.25ozin
- Cable connection: self-releasing screw terminal
- Tightening torque:
 - Switch fixing: 2.5Nm / 22.1lb.in
 - Contact terminals: 0.8Nm / 7lb.in
 - Body lid screw fixing: 0.8Nm / 7lb.in
- Conductor section: 1 or 2 2.5mm² max / 16-14AWG
- Ambient conditions:
 - Operating temperature: -25...+70°C
 - Storage temperature: -40...+70°C
 - Pollution degree: 3
 - IEC degree of protection: IP20 for terminals
 - IEC degree of protection: IP65 for body housing.

Certifications and compliance

Certifications obtained: UL Listed for USA and Canada (cULus - File E93601), as Auxiliary Devices - Limit switches; EAC, CCC.

Compliant with standards: EN/BS 50047, IEC/EN/BS 60947-1, IEC/EN/BS 60947-5-1, IEC/EN/BS 60204-1, UL508, CSA C22.2 n° 14.

▶ Forward travel of snap action contacts □ open
 ◀ Return travel of snap action contacts ■ closed

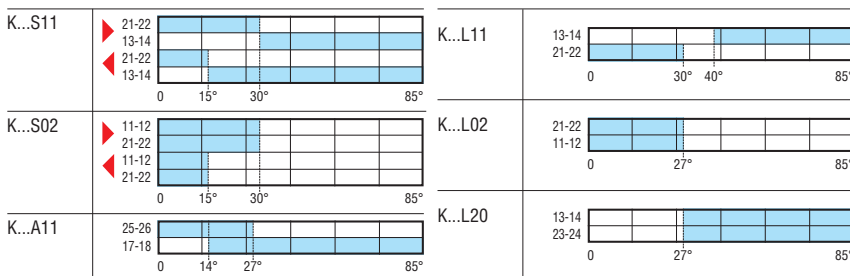

9 Limit, micro and foot switches

Limit switches, K series. One bottom cable entry. Dimensions to EN/BS 50047
Two side cable entries. Dimensions compatible to EN/BS 50047

Ceramic rod lever

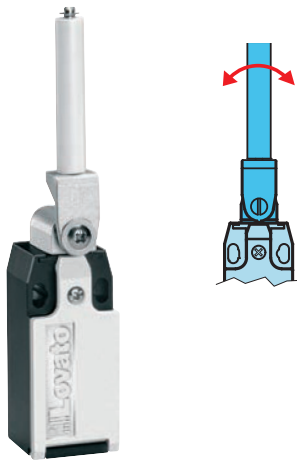

KBH... - KMH...



KCH... - KNH...

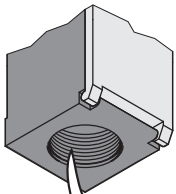

M20 CABLE ENTRY

For types with PG13.5 cable entry, add the letter P at the end of the order code while for 1/2 NPT, add N. E.g. KBH1S11P - KBH1S11N

Order code Plastic body	Metal body	Contacts	Rod material	Qty per pkg n°	Wt [kg]
-------------------------	------------	----------	--------------	----------------	---------

One bottom cable entry. Dimensions to EN/BS 50047.

KBH1S11	KMH1S11	1NO+1NC Snap action ①	Ceramic	5	②
KBH1S02	KMH1S02	2NC Snap action ①	Ceramic	5	②
KBH1A11	KMH1A11	1NO+1NC Slow action make before break ①	Ceramic	5	②
KBH1L11	KMH1L11	1NO+1NC Slow action ①	Ceramic	5	②
KBH1L02	KMH1L02	2NC Slow action ①	Ceramic	5	②
KBH1L20	KMH1L20	2NO Slow action	Ceramic	5	②
KBH1L12	KMH1L12	1NO+2NC Slow action ①	Ceramic	5	②
KBH1L21	KMH1L21	2NO+1NC Slow action ①	Ceramic	5	②
KBH1L03	KMH1L03	3NC Slow action ①	Ceramic	5	②

Two side cable entries. Dimensions compatible to EN/BS 50047.

KCH1S11	KNH1S11	1NO+1NC Snap action ①	Ceramic	5	②
KCH1S02	KNH1S02	2NC Snap action ①	Ceramic	5	②
KCH1A11	KNH1A11	1NO+1NC Slow action make before break ①	Ceramic	5	②
KCH1L11	KNH1L11	1NO+1NC Slow action ①	Ceramic	5	②
KCH1L02	KNH1L02	2NC Slow action ①	Ceramic	5	②
KCH1L20	KNH1L20	2NO Slow action	Ceramic	5	②

① Direct (positive) opening action ☺; safety function according to IEC/EN/BS 60947-5-1.

② Consult Technical support for information; see contact details on inside cover.

General characteristics

The LOVATO Electric limit switches have been designed to satisfy requirements comprising quick installation, easy wiring, simple setup, modularity, sturdiness and constant reliability.

The body cover is hinged at the bottom and removable.

The innovative locking bayonet mechanism permits to remove and reposition the operating head in the required configuration with no tools. The heads have axial rotation of 45° angles.

The auxiliary contact blocks are removable assuring remarkable wiring ease.

Operational characteristics

- Maximum operating rate: 3600 cycles/h
- Switching speed: 0.5...1.5m/s
- Mechanical life: >10 million cycles
- IEC conventional thermal current Ith: 10A
- UL/CSA and IEC/EN/BS 60947-5-1 designation:
 - A600 Q300 for KB...-KC... types
 - A300 Q300 for KM...-KN... types
- IEC rated insulation voltage Ui:
 - 690VAC for KB...-KC... types
 - 440VAC for KM...-KN... types
- IEC rated impulse withstand voltage Uimp:
 - 6kV for KB...-KC... types
 - 4kV for KM...-KN... types
- Class II insulation for KB...-KC... only
- Contact resistance: <10mΩ
- Short-circuit backup protection: 10A gG/SC quick fuse
- Operators of aluminium-zinc alloy
- Housing:
 - KB...-KC... types: self-extinguishing double-insulation polymer thermoplastic
 - KM...-KN... types: aluminium-zinc alloy
- Cable entry: M20 standard supplied; PG13.5 and 1/2 NPT available (see the side note for details)
- Operating head fixing: locking bayonet insert
- Operating torque: 3Ncm/4.25ozin
- Cable connection: self-releasing screw terminal
- Tightening torque:
 - Switch fixing: 2.5Nm / 22.1lb.in
 - Contact terminals: 0.8Nm / 7lb.in
 - Body lid screw fixing: 0.8Nm / 7lb.in
- Conductor section: 1 or 2 2.5mm² max / 16-14AWG
- Ambient conditions:
 - Operating temperature: -25...+70°C
 - Storage temperature: -40...+70°C
 - Pollution degree: 3
 - IEC degree of protection: IP20 for terminals
 - IEC degree of protection: IP65 for body housing.

Certifications and compliance

Certifications obtained: UL Listed for USA and Canada (cULus - File E93601), as Auxiliary Devices - Limit switches; EAC, CCC.

Compliant with standards: EN/BS 50047, IEC/EN/BS 60947-1, IEC/EN/BS 60947-5-1, IEC/EN/BS 60204-1, UL508, CSA C22.2 n° 14.

- ▶ Forward travel of snap action contacts
- ◀ Return travel of snap action contacts

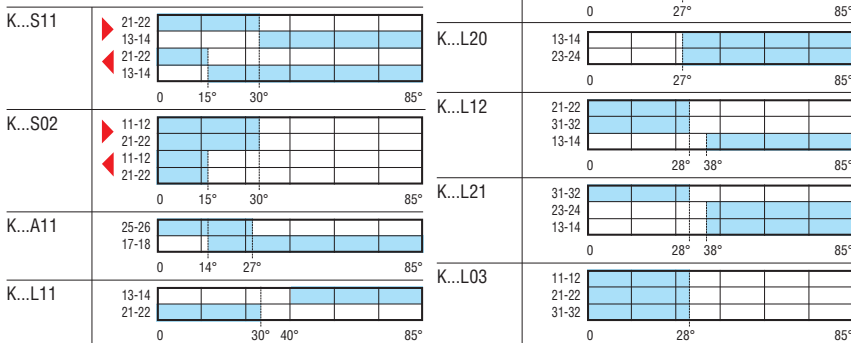

9 Limit, micro and foot switches

Limit switches, K series. One bottom cable entry. Dimensions to EN/BS 50047
Two side cable entries. Dimensions compatible to EN/BS 50047

Adjustable rod lever



KBL... - KML...

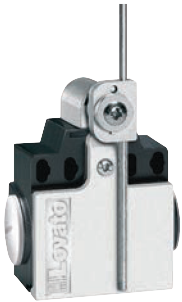

KCL... - KNL...

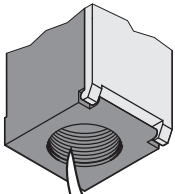

M20 CABLE ENTRY

For types with PG13.5 cable entry, add the letter P at the end of the order code while for 1/2 NPT, add N. E.g. KBL1S11P - KBL1S11N

Order code Plastic body	Metal body	Contacts	Rod material	Qty per pkg	Wt
				n°	[kg]

One bottom cable entry. Dimensions to EN/BS 50047.

KBL1S11	KML1S11	1NO+1NC	Plastic	5	⊕
KBL2S11	KML2S11	Snap actionⓈ	Steel	5	⊕
KBL1S02	KML1S02	2NC	Plastic	5	⊕
KBL2S02	KML2S02	Snap actionⓈ	Steel	5	⊕
KBL1A11	KML1A11	1NO+1NC	Plastic	5	⊕
KBL2A11	KML2A11	Slow action make before breakⓈ	Steel	5	⊕
KBL1L11	KML1L11	1NO+1NC	Plastic	5	⊕
KBL2L11	KML2L11	Slow actionⓈ	Steel	5	⊕
KBL1L02	KML1L02	2NC	Plastic	5	⊕
KBL2L02	KML2L02	Slow actionⓈ	Steel	5	⊕
KBL1L20	KML1L20	2NO	Plastic	5	⊕
KBL2L20	KML2L20	Slow action	Steel	5	⊕
KBL1L12	KML1L12	1NO+2NC	Plastic	5	⊕
KBL2L12	KML2L12	Slow actionⓈ	Steel	5	⊕
KBL1L21	KML1L21	2NO+1NC	Plastic	5	⊕
KBL2L21	KML2L21	Slow actionⓈ	Steel	5	⊕
KBL1L03	KML1L03	3NC	Plastic	5	⊕
KBL2L03	KML2L03	Slow actionⓈ	Steel	5	⊕

Two side cable entries. Dimensions compatible to EN/BS 50047.

KCL1S11	KNL1S11	1NO+1NC	Plastic	5	⊕
KCL2S11	KNL2S11	Snap actionⓈ	Steel	5	⊕
KCL1S02	KNL1S02	2NC	Plastic	5	⊕
KCL2S02	KNL2S02	Snap actionⓈ	Steel	5	⊕
KCL1A11	KNL1A11	1NO+1NC	Plastic	5	⊕
KCL2A11	KNL2A11	Slow action make before breakⓈ	Steel	5	⊕
KCL1L11	KNL1L11	1NO+1NC	Plastic	5	⊕
KCL2L11	KNL2L11	Slow actionⓈ	Steel	5	⊕
KCL1L02	KNL1L02	2NC	Plastic	5	⊕
KCL2L02	KNL2L02	Slow actionⓈ	Steel	5	⊕
KCL1L20	KNL1L20	2NO	Plastic	5	⊕
KCL2L20	KNL2L20	Slow action	Steel	5	⊕

BI-DIRECTIONAL.

One bottom cable entry. Dimensions to EN/BS 50047.

KBL1D02	KML1D02	2NC Ⓢ independent	PlasticⓈ	5	⊕
KBL2D02	KML2D02	2NC Ⓢ independent	SteelⓈ	5	⊕

Ⓢ Direct (positive) opening action ⊖; safety function according to IEC/EN/BS 60947-5-1.

Ⓢ Consult Technical support for information; see contact details on inside cover.

General characteristics

The LOVATO Electric limit switches have been designed to satisfy requirements comprising quick installation, easy wiring, simple setup, modularity, sturdiness and constant reliability.

The body cover is hinged at the bottom and removable. The innovative locking bayonet mechanism permits to remove and reposition the operating head in the required configuration with no tools. The heads have axial rotation of 90° angles (180° for KC... and KN... types). The auxiliary contact blocks are removable assuring remarkable wiring ease.

Operational characteristics

- Maximum operating rate: 3600 cycles/h
- Switching speed: 0.5...1.5m/s
- Mechanical life: >10 million cycles
- IEC conventional thermal current Ith: 10A
- UL/CSA and IEC/EN/BS 60947-5-1 designation:
 - A600 Q300 for KB...-KC... types
 - A300 Q300 for KM...-KN... types
- IEC rated insulation voltage Ui:
 - 690VAC for KB...-KC... types
 - 440VAC for KM...-KN... types
- IEC rated impulse withstand voltage Uimp:
 - 6kV for KB...-KC... types
 - 4kV for KM...-KN... types
- Class II insulation for KB...-KC... only
- Contact resistance: <10mΩ
- Short-circuit backup protection: 10A gG/SC quick fuse
- Operators of aluminium-zinc alloy
- Housing:
 - KB...-KC... types: self-extinguishing double-insulation polymer thermoplastic
 - KM...-KN... types: aluminium-zinc alloy
- Cable entry: M20 standard supplied; PG13.5 and 1/2 NPT available (see the side note for details)
- Operating head fixing: locking bayonet insert
- Operating force: 3Ncm/4.25ozin
- Cable connection: self-releasing screw terminal
- Tightening torque:
 - Switch fixing: 2.5Nm / 22.1lb.in
 - Contact terminals: 0.8Nm / 7lb.in
 - Body lid screw fixing: 0.8Nm / 7lb.in
- Conductor section: 1 or 2 2.5mm² max / 16-14AWG
- Ambient conditions:
 - Operating temperature: -25...+70°C
 - Storage temperature: -40...+70°C
 - Pollution degree: 3
 - IEC degree of protection: IP20 for terminals
 - IEC degree of protection: IP65 for body housing.

Certifications and compliance

Certifications obtained: UL Listed for USA and Canada (cULus - File E93601), as Auxiliary Devices - Limit switches; EAC, CCC.

Compliant with standards: EN/BS 50047, IEC/EN/BS 60947-1, IEC/EN/BS 60947-5-1, IEC/EN/BS 60204-1, UL508, CSA C22.2 n° 14.

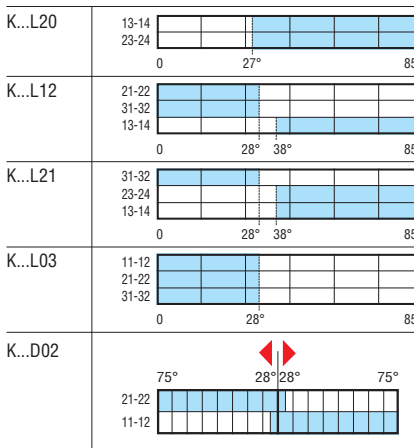
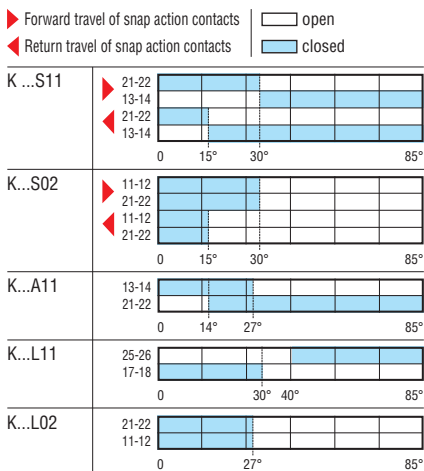

9 Limit, micro and foot switches

Limit switches, K series. One bottom cable entry. Dimensions to EN/BS 50047
Two side cable entries. Dimensions compatible to EN/BS 50047

Wobble stick, omnidirectional



KBM1... - KMM1...



KCM2... - KNM2...

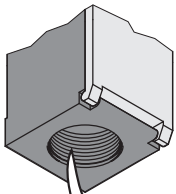

M20 CABLE ENTRY

For types with PG13.5 cable entry, add the letter P at the end of the order code while for 1/2 NPT, add N. E.g. KBM1S11P - KBM1S11N

Order code Plastic body	Metal body	Contacts	Rod material	Qty per pkg n°	Wt [kg]
One bottom cable entry. Dimensions to EN/BS 50047.					
KBM1S11	KMM1S11	1NO+1NC	Flexible	5	ⓘ
KBM2S11	KMM2S11	Snap action	Semirigid	5	ⓘ
KBM1S02	KMM1S02	2NC	Flexible	5	ⓘ
KBM2S02	KMM2S02	Snap action	Semirigid	5	ⓘ
KBM1A11	KMM1A11	1NO+1NC	Flexible	5	ⓘ
KBM2A11	KMM2A11	Slow action make before break	Semirigid	5	ⓘ
KBM1L11	KMM1L11	1NO+1NC	Flexible	5	ⓘ
KBM2L11	KMM2L11	Slow action	Semirigid	5	ⓘ
KBM1L02	KMM1L02	2NC	Flexible	5	ⓘ
KBM2L02	KMM2L02	Slow action	Semirigid	5	ⓘ
KBM1L20	KMM1L20	2NO	Flexible	5	ⓘ
KBM2L20	KMM2L20	Slow action	Semirigid	5	ⓘ
KBM1L12	KMM1L12	1NO+2NC	Flexible	5	ⓘ
KBM2L12	KMM2L12	Slow action	Semirigid	5	ⓘ
KBM1L21	KMM1L21	2NO+1NC	Flexible	5	ⓘ
KBM2L21	KMM2L21	Slow action	Semirigid	5	ⓘ
KBM1L03	KMM1L03	3NC	Flexible	5	ⓘ
KBM2L03	KMM2L03	Slow action	Semirigid	5	ⓘ

Two side cable entries. Dimensions compatible to EN/BS 50047.

KCM1S11	KNM1S11	1NO+1NC	Flexible	5	ⓘ
KCM2S11	KNM2S11	Snap action	Semirigid	5	ⓘ
KCM1S02	KNM1S02	2NC	Flexible	5	ⓘ
KCM2S02	KNM2S02	Snap action	Semirigid	5	ⓘ
KCM1A11	KNM1A11	1NO+1NC	Flexible	5	ⓘ
KCM2A11	KNM2A11	Slow action make before break	Semirigid	5	ⓘ
KCM1L11	KNM1L11	1NO+1NC	Flexible	5	ⓘ
KCM2L11	KNM2 L11	Slow action	Semirigid	5	ⓘ
KCM1L02	KNM1L02	2NC	Flexible	5	ⓘ
KCM2L02	KNM2L02	Slow action	Semirigid	5	ⓘ
KCM1L20	KNM1L20	2NO	Flexible	5	ⓘ
KCM2L20	KNM2L20	Slow action	Semirigid	5	ⓘ

ⓘ Consult Technical support for information; see contact details on inside cover.

General characteristics

The LOVATO Electric limit switches have been designed to satisfy requirements comprising quick installation, easy wiring, simple setup, modularity, sturdiness and constant reliability.

The body cover is hinged at the bottom and removable. The innovative locking bayonet mechanism permits to remove and reposition the operating head in the required configuration with no tools. The auxiliary contact blocks are removable assuring remarkable wiring ease.

Operational characteristics

- Maximum operating rate: 3600 cycles/h
- Switching speed: 0.5...1.5m/s
- Mechanical life: >10 million cycles
- IEC conventional thermal current Ith: 10A
- UL/CSA and IEC/EN/BS 60947-5-1 designation:
 - A600 Q300 for KB...-KC... types
 - A300 Q300 for KM...-KN... types
- IEC rated insulation voltage Ui:
 - 690VAC for KB...-KC... types
 - 440VAC for KM...-KN... types
- IEC rated impulse withstand voltage Uimp:
 - 6kV for KB...-KC... types
 - 4kV for KM...-KN... types
- Class II insulation for KB...-KC... only
- Contact resistance: <10mΩ
- Short-circuit backup protection: 10A gG/SC quick fuse
- Operators of aluminium-zinc alloy
- Housing:
 - KB...-KC... types: self-extinguishing double-insulation polymer thermoplastic
 - KM...-KN... types: aluminium-zinc alloy
- Cable entry: M20 standard supplied; PG13.5 and 1/2 NPT available (see the side note for details)
- Operating head fixing: locking bayonet insert
- Operating torque: 1Ncm/1.42ozin
- Cable connection: self-releasing screw terminal
- Tightening torque:
 - Switch fixing: 2.5Nm / 22.1lb.in
 - Contact terminals: 0.8Nm / 7lb.in
 - Body lid screw fixing: 0.8Nm / 7lb.in
- Conductor section: 1 or 2 2.5mm² max / 16-14AWG
- Ambient conditions:
 - Operating temperature: -25...+70°C
 - Storage temperature: -40...+70°C
 - Pollution degree: 3
 - IEC degree of protection: IP20 for terminals
 - IEC degree of protection: IP65 for body housing.

Certifications and compliance

Certifications obtained: UL Listed for USA and Canada (cULus - File E93601), as Auxiliary Devices - Limit switches; EAC, CCC.
Compliant with standards: EN/BS 50047, IEC/EN/BS 60947-1, IEC/EN/BS 60947-5-1, IEC/EN/BS 60204-1, UL508, CSA C22.2 n° 14.

- ▶ Forward travel of snap action contacts
- ◀ Return travel of snap action contacts

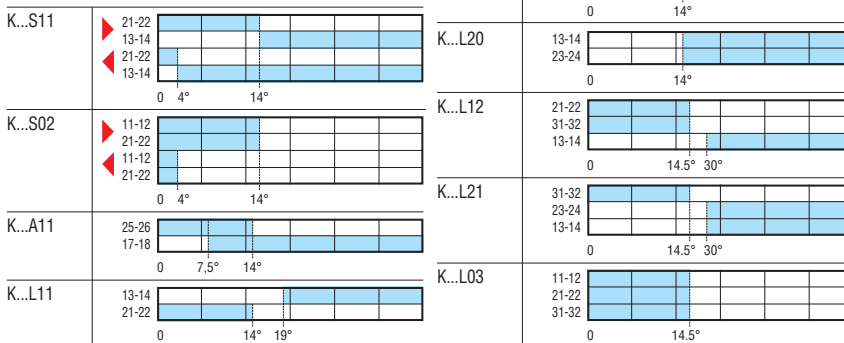

9 Limit, micro and foot switches

Limit switches, K series. One bottom cable entry. Dimensions to EN/BS 50047
Two side cable entries. Dimensions compatible to EN/BS 50047

Hinge operating



KBP... - KMP...



KCP... - KNP...

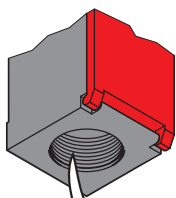

M20 CABLE ENTRY

For types with PG13.5 cable entry, add the letter P at the end of the order code while for 1/2 NPT, add N. E.g. KBP1L11P - KBP1L11N

Order code	Plastic body	Metal body	Contacts	Shaft features	Qty per pkg	Wt
					n°	[kg]

One bottom cable entry. Dimensions to EN/BS 50047.

KBP1L11	KMP1L11	1NO+1NC Slow action Ⓢ	Short cylinder	5	Ⓢ
KBP2L11	KMP2L11	1NO+1NC Slow action Ⓢ	Long solid	5	Ⓢ
KBP3L11	KMP3L11	1NO+1NC Slow action Ⓢ	Long solid w/ reduction	5	Ⓢ
KBP1L02	KMP1L02	2NC Slow action Ⓢ	Short cylinder	5	Ⓢ
KBP2L02	KMP2L02	2NC Slow action Ⓢ	Long solid	5	Ⓢ
KBP3L02	KMP3L02	2NC Slow action Ⓢ	Long solid w/ reduction	5	Ⓢ
KBP1L12	KMP1L12	1NO+2NC Slow action Ⓢ	Short cylinder	5	Ⓢ
KBP2L12	KMP2L12	1NO+2NC Slow action Ⓢ	Long solid	5	Ⓢ
KBP3L12	KMP3L12	1NO+2NC Slow action Ⓢ	Long solid w/ reduction	5	Ⓢ
KBP1L21	KMP1L21	2NO+1NC Slow action Ⓢ	Short cylinder	5	Ⓢ
KBP2L21	KMP2L21	2NO+1NC Slow action Ⓢ	Long solid	5	Ⓢ
KBP3L21	KMP3L21	2NO+1NC Slow action Ⓢ	Long solid w/ reduction	5	Ⓢ
KBP1L03	KMP1L03	3NC Slow action Ⓢ	Short cylinder	5	Ⓢ
KBP2L03	KMP2L03	3NC Slow action Ⓢ	Long solid	5	Ⓢ
KBP3L03	KMP3L03	3NC Slow action Ⓢ	Long solid w/ reduction	5	Ⓢ

Two side cable entries. Dimensions compatible to EN/BS 50047.

KCP1L11	KNP1L11	1NO+1NC Slow action Ⓢ	Short cylinder	5	Ⓢ
KCP2L02	KNP2L02	1NO+1NC Slow action Ⓢ	Long solid	5	Ⓢ
KCP3L11	KNP3L11	1NO+1NC Slow action Ⓢ	Long solid w/ reduction	5	Ⓢ
KCP1L02	KNP1L02	2NC Slow action Ⓢ	Short cylinder	5	Ⓢ
KCP2L02	KNP2L02	2NC Slow action Ⓢ	Long solid	5	Ⓢ
KCP3L02	KNP3L02	2NC Slow action Ⓢ	Long solid w/ reduction	5	Ⓢ

Ⓢ Direct (positive) opening action ⊖; safety function according to IEC/EN/BS 60947-5-1.

Ⓢ Consult Technical support for information; see contact details on inside cover.

General characteristics

The LOVATO Electric limit switches have been designed to satisfy requirements comprising quick installation, easy wiring, simple setup, modularity, sturdiness and constant reliability.

The body cover is hinged at the bottom and removable.

The innovative locking bayonet mechanism permits to remove and reposition the operating head in the required configuration with no tools.

The auxiliary contact blocks are removable assuring remarkable wiring ease.

Operational characteristics

- Maximum operating rate: 3600 cycles/h
- Switching speed: 0.5...1.5m/s
- Mechanical life: 100,000 cycles
- B10d: 100,000 cycles
- IEC conventional thermal current Ith: 10A
- UL/CSA and IEC/EN/BS 60947-5-1 designation:
 - A600 Q300 for KB...-KC... types
 - A300 Q300 for KM...-KN... types
- IEC rated insulation voltage Ui:
 - 690VAC for KB...-KC... types
 - 440VAC for KM...-KN... types
- IEC rated impulse withstand voltage Uimp:
 - 6kV for KB...-KC... types
 - 4kV for KM...-KN... types
- Class II insulation for KB...-KC... only
- Contact resistance: <10mΩ
- Short-circuit backup protection: 10A gG/SC quick fuse
- Operators of aluminium-zinc alloy
- Housing:
 - KB...-KC... types: self-extinguishing double-insulation polymer thermoplastic
 - KM...-KN... types: aluminium-zinc alloy
- Cable entry: M20 standard supplied; PG13.5 and 1/2 NPT available (see the side note for details)
- Operating head fixing: locking bayonet insert
- Operating torque: 15Ncm/21.2ozin
- Cable connection: self-releasing screw terminal
- Tightening torque:
 - Switch fixing: 2.5Nm / 22.1lb.in
 - Contact terminals: 0.8Nm / 7lb.in
 - Body lid screw fixing: 0.8Nm / 7lb.in
- Conductor section: 1 or 2 2.5mm² max / 16-14AWG
- Ambient conditions:
 - Operating temperature: -25...+70°C
 - Storage temperature: -40...+70°C
 - Pollution degree: 3
 - IEC degree of protection: IP20 for terminals
 - IEC degree of protection: IP65 for body housing.

Certifications and compliance

Certifications obtained: UL Listed for USA and Canada (cULus - File E93601), as Auxiliary Devices - Limit switches; EAC, CCC.

Compliant with standards: EN/BS 50047, IEC/EN/BS 60947-1, IEC/EN/BS 60947-5-1, IEC/EN/BS 60204-1, UL508, CSA C22.2 n° 14.

□ open
■ closed

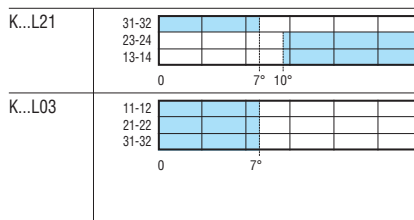
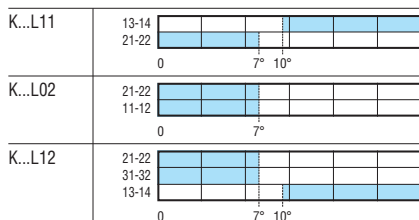

9 Limit, micro and foot switches

Limit switches, K series. One bottom cable entry. Dimensions to EN/BS 50047
Two side cable entries. Dimensions compatible to EN/BS 50047

Slotted lever

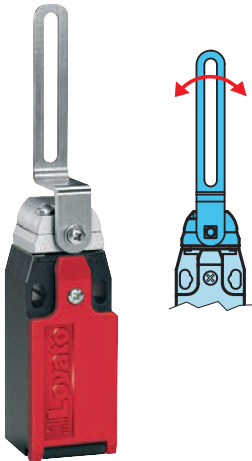

KBQ... - KMQ...



KCQ... - KNQ...

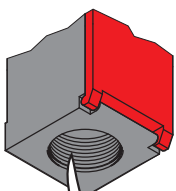

M20 CABLE ENTRY
For types with PG13.5 cable entry, add the letter P at the end of the order code while for 1/2 NPT, add N.
E.g. KBQ1L11P - KBQ1L11N

Order code Plastic body	Order code Metal body	Contacts	Qty per pkg	Wt [kg]
One bottom cable entry. Dimensions to EN/BS 50047.				
KBQ1L11	KMQ1L11	1NO+1NC Slow action ①	5	②
KBQ1L02	KMQ1L02	2NC Slow action ①	5	②
KBQ1L12	KMQ1L12	1NO+2NC Slow action ①	5	②
KBQ1L21	KMQ1L21	2NO+1NC Slow action ①	5	②
KBQ1L03	KMQ1L03	3NC Slow action ①	5	②

Two side cable entries. Dimensions compatible to EN/BS 50047.

KCQ1L11	KNQ1L11	1NO+1NC Slow action ①	5	②
KCQ1L02	KNQ1L02	2NC Slow action ①	5	②

① Direct (positive) opening action \ominus ; safety function according to IEC/EN/BS 60947-5-1.
② Consult Technical support for information; see contact details on inside cover.

General characteristics

The LOVATO Electric limit switches have been designed to satisfy requirements comprising quick installation, easy wiring, simple setup, modularity, sturdiness and constant reliability.

The body cover is hinged at the bottom and removable. The innovative locking bayonet mechanism permits to remove and reposition the operating head in the required configuration with no tools. The auxiliary contact blocks are removable assuring remarkable wiring ease.

Operational characteristics

- Maximum operating rate: 3600 cycles/h
- Switching speed: 0.5...1.5m/s
- Mechanical life: 100,000 cycles
- B10d: 100,000 cycles
- IEC conventional thermal current Ith: 10A
- UL/CSA and IEC/EN/BS 60947-5-1 designation:
 - A600 Q300 for KB...-KC... types
 - A300 Q300 for KM...-KN... types
- IEC rated insulation voltage Ui:
 - 690VAC for KB...-KC... types
 - 440VAC for KM...-KN... types
- IEC rated impulse withstand voltage Uimp:
 - 6kV for KB...-KC... types
 - 4kV for KM...-KN... types
- Class II insulation for KB...-KC... only
- Contact resistance: <10mΩ
- Short-circuit backup protection: 10A gG/SC quick fuse
- Operators of aluminium-zinc alloy
- Housing:
 - KB...-KC... types: self-extinguishing double-insulation polymer thermoplastic
 - KM...-KN... types: aluminium-zinc alloy
- Cable entry: M20 standard supplied; PG13.5 and 1/2 NPT available (see the side note for details)
- Operating head fixing: locking bayonet insert
- Operating torque: 15Ncm/21.2ozin
- Cable connection: self-releasing screw terminal
- Tightening torque:
 - Switch fixing: 2.5Nm / 22.1lb.in
 - Contact terminals: 0.8Nm / 7lb.in
 - Body lid screw fixing: 0.8Nm / 7lb.in
- Conductor section: 1 or 2 2.5mm² max / 16-14AWG
- Ambient conditions:
 - Operating temperature: -25...+70°C
 - Storage temperature: -40...+70°C
 - Pollution degree: 3
 - IEC degree of protection: IP20 for terminals
 - IEC degree of protection: IP65 for body housing.

Certifications and compliance

Certifications obtained: UL Listed for USA and Canada (cULus - File E93601), as Auxiliary Devices - Limit switches; EAC, CCC.
Compliant with standards: EN/BS 50047, IEC/EN/BS 60947-1, IEC/EN/BS 60947-5-1, IEC/EN/BS 60204-1, UL508, CSA C22.2 n° 14.

□ open
■ closed

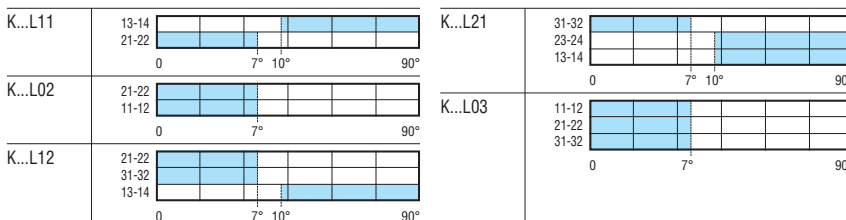

9 Limit, micro and foot switches

Limit switches, K series. One bottom cable entry. Dimensions to EN/BS 50047
Two side cable entries. Dimensions compatible to EN/BS 50047

Key operated



KBN...



KCN...

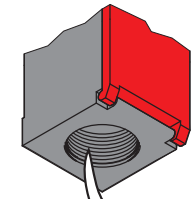

M20 CABLE ENTRY

For types with PG13.5 cable entry, add the letter P at the end of the order code while for 1/2 NPT, add N. E.g. KBN1L11P - KBN1L11N

□ open
■ closed

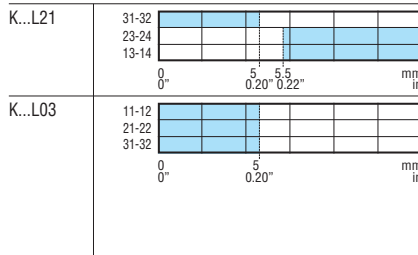
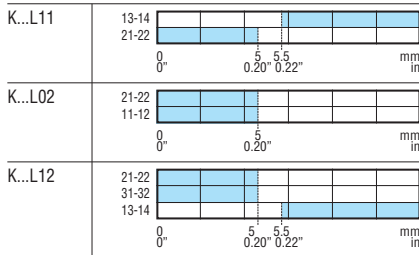

Order code Plastic body	Contacts	Key shape [⊕]	Qty per pkg n°	Wt [kg]
-------------------------------	----------	---------------------------	-------------------------	------------

One bottom cable entry. Dimensions to EN/BS 50047.

KBN1L11	1NO+1NC	Straight	5	0.092
KBN2L11	Slow action [⊖]	Angled	5	0.092
KBN3L11		Straight "T"	5	0.092
KBN4L11		Angled "T"	5	0.092
KBN1L02		2NC	Straight	5
KBN2L02	Slow action [⊖]	Angled	5	0.092
KBN3L02		Straight "T"	5	0.092
KBN4L02		Angled "T"	5	0.092
KBN1L12		1NO+2NC	Straight	5
KBN2L12	Slow action [⊖]	Angled	5	0.096
KBN3L12		Straight "T"	5	0.096
KBN4L12		Angled "T"	5	0.096
KBN1L21	2NO+1NC	Straight	5	0.096
KBN2L21	Slow action [⊖]	Angled	5	0.096
KBN3L21		Straight "T"	5	0.096
KBN4L21		Angled "T"	5	0.096
KBN1L03	3NC	Straight	5	0.096
KBN2L03	Slow action [⊖]	Angled	5	0.096
KBN3L03		Straight "T"	5	0.096
KBN4L03		Angled "T"	5	0.096

Two side cable entries. Dimensions compatible to EN/BS 50047.

KCN1L11	1NO+1NC	Straight	5	0.107
KCN2L11	Slow action [⊖]	Angled	5	0.107
KCN3L11		Straight "T"	5	0.107
KCN4L11		Angled "T"	5	0.107
KCN1L02	2NC	Straight	5	0.107
KCN2L02	Slow action [⊖]	Angled	5	0.107
KCN3L02		Straight "T"	5	0.107
KCN4L02		Angled "T"	5	0.107

⊕ Direct (positive) opening action ⊖; safety function according to IEC/EN/BS 60947-5-1.

⊕ The key is standard supplied.

General characteristics

The LOVATO Electric limit switches have been designed to satisfy requirements comprising quick installation, easy wiring, simple setup, modularity, sturdiness and constant reliability.

The body cover is hinged at the bottom and removable. The heads have axial rotation in any of 4 positions at 90° angles.

The auxiliary contact blocks are removable assuring remarkable wiring ease.

Operational characteristics

- Maximum operating rate: 3600 cycles/h
- Switching speed: 0.5...1.5m/s
- Mechanical life: 100,000 cycles
- B10d: 100,000 cycles
- IEC conventional thermal current Ith: 10A
- UL/CSA and IEC/EN/BS 60947-5-1 designation:
 - A600 Q600
- IEC rated insulation voltage Ui: 690V
- IEC rated impulse withstand voltage Uimp: 6kV
- Class II insulation
- Contact resistance: <10mΩ
- Short-circuit backup protection: 10A gG/SC quick fuse
- Housing and operators in self-extinguishing double-insulation polymer thermoplastic
- Cable entry: M20 standard supplied; PG13.5 and 1/2 NPT available (see the side note for details)
- Operating head fixing: locking bayonet insert
- Operating force: 8N/1.8lb
- Cable connection: self-releasing screw terminal
- Tightening torque:
 - Switch fixing: 2.5Nm / 22.1lb.in
 - Contact terminals: 0.8Nm / 7lb.in
 - Body lid screw fixing: 0.8Nm / 7lb.in
- Conductor section: 1 or 2 2.5mm² max / 16-14AWG
- Ambient conditions:
 - Operating temperature: -25...+70°C
 - Storage temperature: -40...+70°C
 - Pollution degree: 3
 - IEC degree of protection: IP20 for terminals
 - IEC degree of protection: IP65 for body housing.

Certifications and compliance

Certifications obtained: UL Listed for USA and Canada (cULus - File E93601), as Auxiliary Devices - Limit switches; EAC, CCC.

Compliant with standards: EN/BS 50047, IEC/EN/BS 60947-1, IEC/EN/BS 60947-5-1, IEC/EN/BS 60204-1, UL508, CSA C22.2 n° 14.

Accessories and spare parts for key operated switches



KXN1



KXN2



KXN3



KXN4



KXN5

Order code	Description	Qty per pkg n°	Wt [kg]
KXN1	Straight key	5	0.013
KXN2	Angled key	5	0.013
KXN3	Straight "T" key	5	0.012
KXN4	Angled "T" key	5	0.012
KXN5	Toggle key	5	0.019

9 Limit, micro and foot switches

Limit switches, K series.

Accessories and spare parts for KB - KC - KM and KN type limit switches

INDEX

Contact blocks



KXB...

Order code	Contacts	Qty per pkg	Wt [kg]
KXBS11	1NO+1NC Snap action ^{①②}	5	0.022
KXBS02	2NC Snap action ^{①②}	5	0.022
KXBA11	1NO+1NC Slow action make before break ^{①②}	5	0.022
KXBL11	1NO+1NC Slow action ^②	5	0.022
KXBL02	2NC Slow action ^②	5	0.022
KXBL20	2NO Slow action	5	0.022
KXBL12	1NO+2NC Slow action ^{②③}	5	0.026
KXBL21	2NO+1NC Slow action ^{②③}	5	0.026
KXBL03	3NC Slow action ^{②③}	5	0.026

- ① Not suitable for key operated KBN / KCN, hinged operating KBP / KCP / KMP / KNP and slotted lever KBQ / KCQ / KMQ / KNQ types.
- ② Direct (positive) opening action \curvearrowright ; safety function according to IEC/EN/BS 60947-5-1.
- ③ Not suitable for KC and KN types, KG and KR foot switches.

Body complete with contact block



KXCB... - KXCM...



KXCC... - KXCN...

Order code Plastic body	Order code Metal body	Contacts	Qty per pkg	Wt [kg]
-------------------------	-----------------------	----------	-------------	---------

One bottom cable entry. Dimensions to EN/BS 50047.

KXCBS11	KXCMS11	1NO+1NC Snap action ^{①②}	5	④
KXCBS02	KXCMS02	2NC Snap action ^{①②}	5	④
KXCBA11	KXCMA11	1NO+1NC Slow action make before break ^{①②}	5	④
KXCBL11	KXCML11	1NO+1NC Slow action ^②	5	④
KXCBL02	KXCML02	2NC Slow action ^②	5	④
KXCBL12	KXCML12	1NO+2NC Slow action ^{②③}	5	④
KXCBL21	KXCML21	2NO+1NC Slow action ^{②③}	5	④
KXCBL03	KXCML03	3NC Slow action ^{②③}	5	④

Two side cable entries. Dimensions compatible to EN/BS 50047.

KXCCS11	KXCNS11	1NO+1NC Snap action ^{①②}	5	④
KXCCS02	KXCNS02	2NC Snap action ^{①②}	5	④
KXCCA11	KXCNA11	1NO+1NC Slow action make before break ^{①②}	5	④
KXCCL11	KXCNL11	1NO+1NC Slow action ^②	5	④
KXCCL02	KXCNL02	2NC Slow action ^②	5	④
KXCCL20	KXCNL20	2NO Slow action	5	④

- ① Not suitable for key operated KBN / KCN, hinged operating KBP / KCP / KMP / KNP and slotted lever KBQ / KCQ / KMQ / KNQ types.
- ② Direct (positive) opening action \curvearrowright ; safety function according to IEC/EN/BS 60947-5-1.
- ③ Not suitable for KC and KN types.
- ④ Consult Technical support for information; see contact details on inside cover.

General characteristics

The KXB... contact blocks can be used with the K series of limit switches. Combinations of 2 contacts with slow or snap action and, for KB... and KM... types only, 3 slow action contacts are available.

The NC contacts have direct opening operation, a specific safety principle.

The particular four-point contacts warrant high conductivity in any sort of application. The removal of the contacts from the limit switch body provides remarkable wiring ease and reduces installation time as well.

The KXC... bodies, complete with auxiliary contacts, can be used as spare parts for the K series limit switches or coupled with the KXA... operating heads, to obtain complete limit switches in the required configurations.

The body cover is hinged at the bottom and removable to have the best access. Each body includes the innovative locking bayonet mechanism of the operating head. Plastic and metal types are available.

Operational characteristics

- Mechanical life: >10 million cycles
- IEC conventional thermal current Ith: 10A
- Conductivity: 10mA 5V
- UL/CSA and IEC/EN/BS 60947-5-1 designation:
 - A600 Q300 for KXCB...-KXCC... types
 - A300 Q300 for KXCM...-KXCN... types
- IEC rated insulation voltage Ui:
 - 690VAC for KXCB...-KXCC... types
 - 440VAC for KXCM...-KXCN... types
- IEC rated impulse withstand voltage Uimp:
 - 6kV for KXCB...-KXCC... types
 - 4kV for KXCM...-KXCN... types
- Class II insulation for KXCB...-KXCC... only
- Contact resistance: <10mΩ
- Short-circuit backup protection: 10A gG/SC quick fuse
- Housing:
 - KXCB...-KXCC... types: self-extinguishing double-insulation polymer thermoplastic
 - KXCM...-KXCN... types: aluminium-zinc alloy
- Cable entry: M20 standard supplied; PG13.5 and 1/2 NPT available (see the side note for details)
- Operating head fixing: locking bayonet insert
- Cable connection: self-releasing screw terminal
- Tightening torque:
 - Switch fixing: 2.5Nm / 22.1lb.in
 - Contact terminals: 0.8Nm / 7lb.in
 - Body lid screw fixing: 0.8Nm / 7lb.in
- Conductor section: 1 or 2 2.5mm² max / 16-14AWG
- Ambient conditions:
 - Operating temperature: -25...+70°C
 - Storage temperature: -40...+70°C
 - Pollution degree: 3
 - IEC degree of protection: IP20 for terminals
 - IEC degree of protection: IP65 for body housing.

Certifications and compliance

Certifications obtained: UL Listed for US and Canada (File E93601), as Auxiliary Devices for KX C... body types only. UL Recognized for USA and Canada (cURus - File E93601) as component - Auxiliary devices for contact blocks only; products having this type of marking are intended for use as components of complete workshop-assembled equipment; EAC for all.

Comply with standards: EN/BS50047, IEC/EN/BS 60947-1, IEC/EN/BS 60947-5-1, IEC/EN/BS 60204-1, UL508, CSA C22.2 n° 14.

- ▶ Forward travel of snap action contacts open
- ◀ Return travel of snap action contacts closed

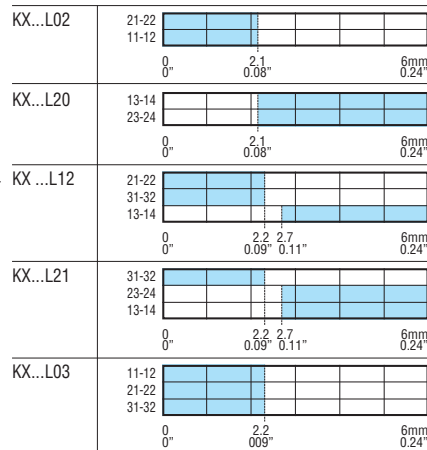
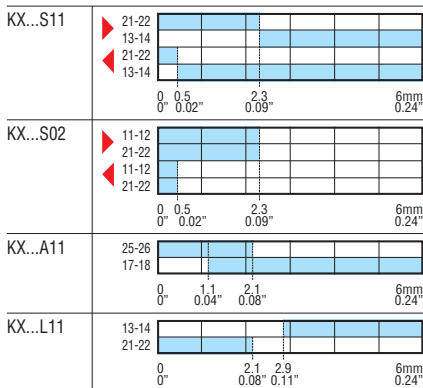

9 Limit, micro and foot switches

Limit switches, K series.

Accessories and spare parts for KB, KC, KM and KN type limit switches

Operating heads

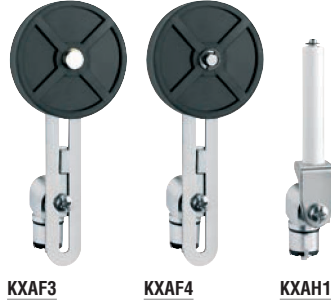
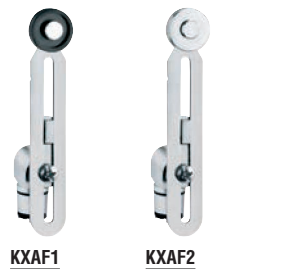

Order code	Description	Qty per pkg	Wt
		n°	[kg]
KXAA1	Top push rod plunger	5	0.013
KXAB1	Plastic top roller push plunger	5	0.019
KXAB2	Metal top roller push plunger	5	0.020
KXAC1	Plastic roller centre push lever	5	0.018
KXAC2	Metal roller centre push lever	5	0.022
KXAD1	Plastic roller side push lever	5	0.018
KXAD2	Metal roller side push lever	5	0.023
KXAE1	Plastic roller lever plunger	5	0.039
KXAE2	Metal roller lever plunger	5	0.048
KXAE3	Rubber Ø50x10mm roller lever plunger	5	0.058
KXAF1	Adjustable plastic roller lever Ø19x5mm ①	5	0.055
KXAF2	Adjustable metal roller lever Ø19x5mm ①	5	0.065
KXAF3	Adjustable rubber Ø50x10mm roller lever	5	0.072
KXAF4	Adjustable offset rubber Ø50x10mm roller lever	5	0.081
KXAH1	Ceramic rod lever	5	0.056
KXAL1	Adjustable plastic rod lever	5	0.043
KXAL2	Adjustable stainless steel rod lever	5	0.051
KXAM1	Flexible wobble stick	5	0.032
KXAM2	Semirigid wobble stick	5	0.023

① Ø19x5mm = Ø0.75"x0.2".

② Ø50x10mm = Ø1.97"x0.39".

General characteristics

The KXA... operating heads can be used as spare parts for the K series limit switches or coupled with the KXC... bodies to obtain complete limit switches in the required configurations.

The heads are made of metal and warrant sturdiness and operating reliability in all conditions.

The shape of the coupling section with the body of the K series switches permits to orient the head in any 45° angle position while the initial lever and rod position can be adjusted 360° at 15° angle positions.

The head fixing to the body is achieved by the innovative locking bayonet mechanism so there is no need of tools. Tightening torque for eventual operating head actuator fixing is 0.8Nm/7lb.in.

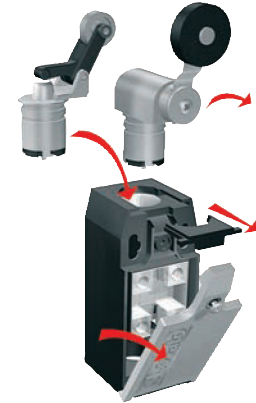

Cable glands and cable conduit



Order code	Description	Qty per pkg	Wt
		n°	[kg]
KXP01	M20 cable gland	50	0.009
KXP02	PG13.5 cable gland	50	0.009
KXP03	M20 rubber cable conduit	50	0.004

General characteristics

The cable glands are in plastic with either M20 or PG13.5 thread and provide to keep the cable in place and maintain the proper IP protection of the limit switch after installation.

Operational characteristics for cable gland

- Material: self-extinguishing polyamide
- IEC degree of protection: IP68
- Gland seal with cable diameter: 6...12mm/0.24...0.47".

Certifications and compliance

Certifications obtained: EAC.
Compliant with standards: EN/BS 50262, UL508.



Order code	Contacts 1NO+1NC	Head material	Cable length ⊕	Qty per pkg	Wt [kg]
			m	n°	

TOP PUSH ROD PLUNGER.

KPA1S11	Snap action ⊕	Metal	2	1	0.286
KPA1L11	Slow action ⊕	Metal	2	1	0.286
KPA2S11⊕	Snap action ⊕	Metal	2	1	0.302
KPA2L11⊕	Slow action ⊕	Metal	2	1	0.302

TOP ROLLER PUSH PLUNGER.

KPB1S11	Snap action ⊕	Plastic	2	1	0.290
KPB1L11	Slow action ⊕	Plastic	2	1	0.290
KPB2S11	Snap action ⊕	Metal	2	1	0.290
KPB2L11	Slow action ⊕	Metal	2	1	0.290
KPB3S11⊕	Snap action ⊕	Plastic	2	1	0.288
KPB3L11⊕	Slow action ⊕	Plastic	2	1	0.288
KPB4S11⊕	Snap action ⊕	Metal	2	1	0.296
KPB4L11⊕	Slow action ⊕	Metal	2	1	0.296

M12 HEAD TOP ROLLER PUSH PLUNGER.

KPB5S11	Snap action ⊕	Plastic	2	1	0.308
KPB5L11	Slow action ⊕	Plastic	2	1	0.308
KPB6S11	Snap action ⊕	Metal	2	1	0.310
KPB6L11	Slow action ⊕	Metal	2	1	0.310
KPB7S11⊕	Snap action ⊕	Plastic	2	1	0.310
KPB7L11⊕	Slow action ⊕	Plastic	2	1	0.310
KPB8S11⊕	Snap action ⊕	Metal	2	1	0.310
KPB8L11⊕	Slow action ⊕	Metal	2	1	0.310

ROLLER LEVER PLUNGER.

KPE1S11	Snap action ⊕	Plastic	2	1	0.336
KPE1L11	Slow action ⊕	Plastic	2	1	0.336
KPE2S11	Snap action ⊕	Metal	2	1	0.336
KPE2L11	Slow action ⊕	Metal	2	1	0.336

ADJUSTABLE ROLLER LEVER.

KPF1S11	Snap action ⊕	Plastic	2	1	0.344
KPF1L11	Slow action ⊕	Plastic	2	1	0.344

ADJUSTABLE ROD LEVER.

KPL2S11	Snap action ⊕	Metal	2	1	0.342
KPL2L11	Slow action ⊕	Metal	2	1	0.342

OMNIDIRECTIONAL WOBBLE STICK.

KPM2S11	Snap action ⊕	Metal	2	1	0.298
---------	---------------	-------	---	---	-------

- ⊕ Direct (positive) opening action ⊖; safety function according to IEC/EN/BS 60947-5-1.
- ⊕ For prewired switches with 1m long cable only, add suffix 010 at the end of the order code.
Example: KPA1S11010 for prewired switch, top push metal rod plunger, with 1NO+1NC snap action contacts and 1m long cable.
- ⊕ M12 head fixing.
- ⊕ Roller operation perpendicular to switch body.

Operational characteristics

- 2 meters long cable ⊕ (5 core, each 0.75mm²/18 AWG)
- Maximum operating rate: 3600 cycles/h
- Mechanical life: >10 million cycles
- IEC conventional thermal current Ith: 10A
- conductivity: 10mA 5V
- UL/CSA and IEC/EN/BS 60947-5-1 designation: B300 R300
- IEC rated insulation voltage Ui: 400VAC
- IEC rated impulse withstand voltage Uimp: 4kV
- Class I insulation
- Contact resistance: <25mΩ
- Body housing: aluminium and zinc alloy
- Operating force/torque:
 - KPA types: 15N / 3.4lb
 - KPB types: 10N / 2.2lb
 - KPE, KPF and KPL types: 0.08Nm / 0.7lb.in
 - KPM types: 0.1Nm / 0.9lb.in
- Tightening torque for switch fixing: 2.5Nm / 22.1lb.in for body housing fixing possible: 0.8Nm / 7lb.in
- Ambient conditions:
 - Operating temperature: -25...+70°C
 - Storage temperature: -40...+70°C
 - Pollution degree: 3
 - IEC degree of protection: IP67 for body housing.

Certifications and compliance

Certifications obtained: UL Listed for USA and Canada (cULus - File E93601), as Auxiliary Devices - Limit switches; EAC.
Compliant with standards: IEC/EN/BS 60947-1, IEC/EN/BS 60947-5-1, UL508, CSA C22.2 n° 14.

- ▶ Forward travel of snap action contacts | open
- ◀ Return travel of snap action contacts | closed

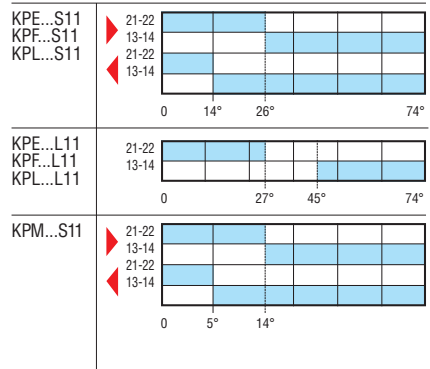
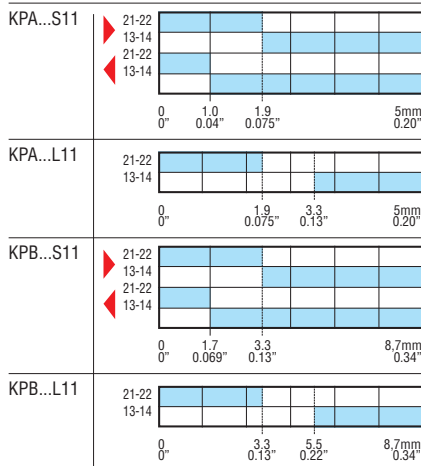

9 Limit, micro and foot switches

Metal limit switches, PL series

Top push rod plunger



PLN...A...

Order code	Contacts	Degree of protection	Qty per pkg	Wt
		IEC	n°	[kg]
PLNA1A	1NCⓘ	IP40	1	0.240
PLNA1AW		IP65	1	0.240
PLNA2A	2NCⓘ	IP40	1	0.240
PLNA2AW		IP65	1	0.240
PLNC1A	1NO	IP40	1	0.240
PLNC1AW		IP65	1	0.240
PLNC2A	2NO	IP40	1	0.240
PLNC2AW		IP65	1	0.240
PLNU1A	1NO+1NC	IP40	1	0.240
PLNU1AW		IP65	1	0.240

ⓘ Direct (positive) opening action ⊖; safety function according to IEC/EN/BS 60947-5-1.

Top roller push plunger



PLN...R...

Order code	Contacts	Degree of protection	Qty per pkg	Wt
		IEC	n°	[kg]
PLNA1R	1NCⓘ	IP40	1	0.230
PLNA1RW		IP65	1	0.230
PLNA2R	2NCⓘ	IP40	1	0.230
PLNA2RW		IP65	1	0.230
PLNC1R	1NO	IP40	1	0.230
PLNC1RW		IP65	1	0.230
PLNC2R	2NO	IP40	1	0.230
PLNC2RW		IP65	1	0.230
PLNU1R	1NO+1NC	IP40	1	0.230
PLNU1RW		IP65	1	0.230

ⓘ Direct (positive) opening action ⊖; safety function according to IEC/EN/BS 60947-5-1.

Roller centre push lever



PLN...H

Order code	Contacts	Degree of protection	Qty per pkg	Wt
		IEC	n°	[kg]
PLNA1H	1NCⓘ	IP40	1	0.270
PLNA1HW		IP65	1	0.270
PLNA2H	2NCⓘ	IP40	1	0.270
PLNA2HW		IP65	1	0.270
PLNU1H	1NO+1NC	IP40	1	0.270
PLNU1HW		IP65	1	0.270
With offset roller.				
PLNA1HSB	1NCⓘ	IP40	1	0.290
PLNA1HSBW		IP65	1	0.290
PLNA2HSB	2NCⓘ	IP40	1	0.290
PLNA2HSBW		IP65	1	0.290
PLNU1HSB	1NO+1NC	IP40	1	0.290
PLNU1HSBW		IP65	1	0.290

ⓘ Direct (positive) opening action ⊖; safety function according to IEC/EN/BS 60947-5-1.



PLN...HSBW

Type	Travel [mm (in)]	Legend
		□ open ■ closed
PLNA1A... PLNA1R...	11-12 1.5 0.06" 11.5 0.45" [mm (in)]	
PLNA1H... PLNA1HSB...	11-12 2.4 0.09" 20 0.79" [mm (in)]	
PLNA2A... PLNA2R...	11-12 21-22 1.5 0.06" 6.5 0.25" [mm (in)]	
PLNA2H... PLNA2HSB...	11-12 21-22 2.4 0.09" 11.5 0.45" [mm (in)]	
PLNC1A... PLNC1R...	13-14 2.2 0.09" 11.5 0.45" [mm (in)]	
PLNC2A... PLNC2R...	13-14 23-24 4.2 0.16" 6.4 0.25" [mm (in)]	
PLNU1A... PLNU1R...	21-22 13-14 1.5 0.06" 11.5 0.45" 5.9 (0.23") [mm (in)]	
PLNU1H... PLNU1HSB...	21-22 13-14 2.4 0.09" 20 0.79" 10.4 (0.41") [mm (in)]	

General characteristics

The PL types are for general purpose use. The extensive range of models with numerous actuators and multiple contact configurations is the optimal solution to the diverse installation requirements.

Overall simple design, oversize contacts and choice materials ensure durable and safe operation. The metal alloy housing and resistant thermoplastic actuators warrant reliable heavy-duty features for any sort of operating conditions.

The PL series limit switches are available with IEC IP40 or IP65 degree of protection; this characteristic is ensured by the use of appropriate sealing gasket.

The IEC IP65 version is easily identified by the "W" suffix of its order code and can be used in adverse ambient conditions.

Operational characteristics

- Maximum operating rate: 3600 cycles/h
- Mechanical life: >10 million cycles
- IEC utilisation category:
 - DC13 duty: 10A 24V
 - AC15 duty: 5A 250V, 3A 400V
- IEC conventional thermal current Ith: 10A
- IEC rated insulation voltage Ui: 400VAC
- Contact resistance: <10mΩ
- Short-circuit backup protection: 10A gG/SC quick fuse
- Housing cable entry: PG11 (PLN...W types only complete with cable gland)
- Cable connection: screw terminal with clamp suitable for cables up to 2.5mm² / 14 AWG
- Tightening torque:
 - Switch fixing: 2.5Nm / 22.1lb.in
 - Contact terminals: 0.8Nm / 7lb.in
 - Body lid screw fixing: 0.8Nm / 7lb.in
- Ambient conditions:
 - Operating temperature: -25...+70°C
 - Storage temperature: -40...+70°C
 - Pollution degree: 3
 - IEC degree of protection: IP40 / IP65 (see table indications).

Certifications and compliance

Certifications obtained: IMQ, EAC.
Compliant with standards: IEC/EN/BS 60947-1, IEC/EN/BS 60947-5-1, EN/BS 81-1.

9 Limit, micro and foot switches

Metal limit switches, PL series



Latch and manual release



PLNA1RAG

Order code	Contacts	Degree of protection	Qty per pkg	Wt
		IEC	n°	[kg]

Top roller push plunger.

PLNA1RAG	1NC	IP40	1	0.220
PLNA1RAGW	1NC	IP65	1	0.230

Direct (positive) opening action ; safety function according to IEC/EN/BS 60947-5-1.

Manual reload and magnetic release



PLA1AM

Order code	Contacts	Degree of protection	Qty per pkg	Wt
		IEC	n°	[kg]

Top push rod plunger.

PLA1AM	1NC	IP40	1	0.245
PLA1AMW	1NC	IP65	1	0.250

Top roller push plunger.

PLA1RM	1NC	IP40	1	0.250
PLA1RMW	1NC	IP65	1	0.260

Direct (positive) opening action ; safety function according to IEC/EN/BS 60947-5-1.



PLA1RMW

Bi-directional



PLN978

Order code	Contacts	Degree of protection	Qty per pkg	Wt
		IEC	n°	[kg]

Rod plunger.

PLN978	2NC independent	IP65	1	0.265
---------------	--------------------	------	---	-------

Direct (positive) opening action ; safety function according to IEC/EN/BS 60947-5-1.

Type	Travel [mm (in)] (The arrows indicate the direction of operation)	open closed
PLNA1RAG PLNA1RAGW	 1 0.04" 7 0.27" 21-22 [mm (in)]	
PLA1AM PLA1AMW PLA1RM PLA1RMW	 0.5 0.02" 8 0.31" 21-22 [mm (in)]	
PLN978	 8 0.31" 0.5 0.02" 0.5 0.02" 8 0.31" 11-12 21-22 [mm (in)]	

General characteristics

The PL limit switches were initially made specifically for hoisting or lifting duty and then used in other diverse applications. The type with latch and manual release as well as the one with manual reload and magnetic release are designed so the switch remains opened after the switching of the NC contact. In the first instance, the contact closing is made by pushing the release button. In the second case, the reloading is obtained by pushing the shaft end or else pulling it from the top for the IP65 types.

The limit switches with dual operation can be replaced by two standard switches, for the stop control of moving mechanisms with two directions of running (e.g. automatic doors). It is equipped with two opposed operating mechanisms and one NC contact for each mechanism (i.e. 2NC).

The simple constructive design, oversize contacts and careful material combinations warrant safe and constant operation. The metal-alloy housing and the thermoplastic mechanism material of first-rate mechanical features assure reliability and durability with any type of operating condition.

Operational characteristics

- Maximum operating rate: 3600 cycles/h
- Mechanical life: >10 million cycles
- IEC utilisation category:
 - DC13 duty: 10A 24V
 - AC15 duty: 5A 250V, 3A 400V
- IEC conventional thermal current I_{th}: 10A
- IEC rated insulation voltage: 400VAC
- Contact resistance: <10mΩ
- Short-circuit backup protection: 10A gG/SC quick fuse
- Housing cable entry: PG11 (PL...W and PLN978 types only complete with cable gland)
- Cable connection: screw terminal with clamp suitable for cables up to 2.5mm² / 14 AWG
- Tightening torque:
 - Switch fixing: 2.5Nm / 22.1lb.in
 - Contact terminals: 0.8Nm / 7lb.in
 - Body lid screw fixing: 0.8Nm / 7lb.in
- Ambient conditions:
 - Operating temperature: -25...+70°C
 - Storage temperature: -40...+70°C
 - Pollution degree: 3
 - IEC degree of protection: IP40 / IP65 (see table indications).

Certifications and compliance

Certifications obtained: IMQ, EAC.
Compliant with standards: IEC/EN/BS 60947-5-1, IEC/EN/BS 60204-1, EN/BS 81-1.

9 Limit, micro and foot switches

Rope-pull lever limit switches for normal stopping

Dimensions to EN/BS 50047



RS113... - RS213... - RS313...

Order code	Contacts	Ring material	Qty per pkg	Wt
			n°	[kg]
Without reset button.				
RS11310	1NO+1NC Snap action	Steel	1	0.090
RS21310	1NO+1NC Slow action	Steel	1	0.090
RS31310	2NO Slow action	Steel	1	0.090

Type	▶ Forward travel of snap action contacts	□ open
	◀ Return travel of snap action contacts	■ closed
RS113...	▶ 21-22 13-14 ◀ 21-22 13-14	
RS213...	21-22 13-14	
RS313...	21-22 11-12	

General characteristics

The RS series limit switches are designed and manufactured according to European standards for dimensions and operating characteristics.

The double-insulated housing of the limit switch is made of glass-reinforced self-extinguishing polyamide resin to protect internal circuits against shocks or impacts and in industrial environments, against accidental ingress of tools and accidental contact.

The contacts are dimensioned to ensure self cleaning of the silver-alloy contact surfaces.

Operational characteristics

- Maximum operating rate: 3600 cycles/h for RS...13
- Switching speed: 0.5...1.5m/s
- Mechanical life: >10 million cycles
- IEC utilisation category:
 - DC13 duty: 1.5A 24V
 - AC15 duty: 6A 250V
- IEC conventional thermal current Ith: 10A
- IEC rated insulation voltage Ui: 250VAC
- Contact resistance: <10mΩ
- Short-circuit backup protection: 10A gG/SC quick fuse
- Operating force: 25N/5.6lb
- Cable entry: PG11 (RS...13)
- Cable connection: self-releasing screw terminal
- Tightening torque:
 - Switch fixing: 2.5Nm / 22.1lb.in
 - Contact terminals: 0.8Nm / 7lb.in
 - Body lid screw fixing: 0.8Nm / 7lb.in
- Conductor section: 1 or 2 2.5mm² max / 16-14 AWG
- Ambient conditions:
 - Operating temperature: -25...+70°C
 - Storage temperature: -40...+70°C
 - Pollution degree: 3
 - IEC degree of protection: IP65 (RS...13).

Certifications and compliance

Certifications obtained: UL Listed for USA and Canada (cULus - File E93601), as Auxiliary Devices - Limit switches; EAC.

Compliant with standards: IEC/EN/BS 60947-1, IEC/EN/BS 60947-5-1, IEC/EN/BS 60204-1, EN/BS 81-1, EN/BS 50041, UL508, CSA C22.2 n° 14.

9 Limit, micro and foot switches

Rope-pull lever limit switches for normal stopping



PLN...AT...W

Order code	Contacts	Degree of protection	Operating force	Qty per pkg	Wt
		IEC	[N] / [lb]	n°	[kg]

Without reset button

PLNU1AT	1NO+1NC	IP40	10 / 2.2	1	0.240
PLNU1ATW	①	IP65	10 / 2.2	1	0.240
PLNU1AT25	1NO+1NC	IP40	25 / 5.6	1	0.240
PLNU1AT25W	①	IP65	25 / 5.6	1	0.240

① Direct (positive) opening action ⊖; safety function according to IEC/EN/BS 60947-5-1.

Order code	Contacts	Degree of protection	Operating force	Qty per pkg	Wt
		IEC	[N] / [lb]	n°	[kg]

Without reset button.

P2L81311	1NO+1NC	IP65	40 / 9	1	0.459
P2L81312	①	IP65	120 / 27	1	0.459
P2L101311	2NO+2NC	IP65	40 / 9	1	0.459
P2L101312	①	IP65	120 / 27	1	0.459

① Direct (positive) opening action ⊖; safety function according to IEC/EN/BS 60947-5-1.



P2L...

Type	Travel [mm (in)]	Legend
PLNU1AT...		
P2L8...		
P2L10...		

General characteristics

The PLN and P2L types are limit switches for general use. The simple constructive design, oversize contacts and careful material combinations warrant safe and constant operation. The metal-alloy housing and the thermoplastic mechanism material of first-rate mechanical features assure reliability and durability with any type of operating condition.

Operational characteristics

- Maximum operating rate: 3600 cycles/h
- Mechanical life: >10 million cycles
- IEC utilisation category:
 - DC13 duty: 10A 24V
 - AC15 duty: 5A 250V; 3A 400V
- IEC conventional thermal current Ith: 10A for PLN types; 6A for P2L types
- IEC rated insulation voltage Ui: 400VAC
- Contact resistance: <10mΩ
- Short-circuit backup protection: 10A gG/SC quick fuse
- Cable entry: PG11 (PLN...W and P2L types only complete with cable gland)
- Cable connection: self-releasing screw terminal suitable for cables up to 2.5mm² / 14 AWG
- Tightening torque for switch fixing: 2.5Nm/2.21lb.in
- Ambient conditions:
 - Operating temperature: -25...+70°C
 - Storage temperature: -40...+70°C
 - Pollution degree: 3
 - IEC degree of protection: IP40 / IP65 (see order code table indications).

Certifications and compliance

Certifications obtained: IMQ.
Compliant with standards: IEC/EN/BS 60947-1, IEC/EN/BS 60947-5-1, EN/BS 81-1.

9 Limit, micro and foot switches

Rope-pull lever limit switches for emergency stopping, ISO 13850 compliant.
Accessories and spare parts



RS131310



PLN131311



P2L...

Accessories and spare parts



P33032



P33033



P33034



P33035



P33036

Order code	Contacts	Force	Qty per pkg	Wt
		[N]/[lb]	n°	[kg]
With reset button.				
RS131310	1NO + 1NC	25/5.6	1	0.092
PLN131311	1NO + 1NC	60/13.5	1	0.248
P2L131311	1NO + 1NC	40/9	1	0.459
P2L131312	1NO + 1NC	120/27	1	0.459
P2L151311	2NO + 2NC	40/9	1	0.459
P2L151312	2NO + 2NC	120/27	1	0.459

- ① Direct (positive) opening action \ominus ; safety function according to IEC/EN/BS 60947-5-1.
- ② Dimensions according with EN/BS 50047.
- ③ Dimensions according with EN/BS 50041.

Example of wiring diagram

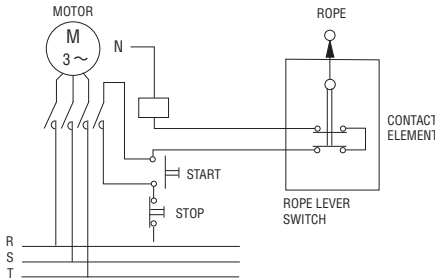

Type	Travel [mm (in)]	Legend
		□ open ■ closed
RS...	11-12 21-22 0 [mm (in)] 6 (0.24")	
PLN...	11-12 21-22 0 [mm (in)] 8 (0.31")	
P2L13...	11-12 21-22 0 [mm (in)] 10 (0.39")	
P2L15...	31-32 41-42 13-14 23-24 0 [mm (in)] 10 (0.39")	

General characteristics

The rope-operated switches for emergency stop are mainly suitable for emergency stop or alarm systems for machinery which occupies a large space. This emergency stop can be achieved from any point when the rope is manually pulled each time.

The choice of the body, between plastic and metal, can satisfy the most diversified requirements for sturdiness and size.

Operational characteristics

- Maximum operating rate: 1800 cycles/h
- Mechanical life: 100,000 cycles
- IEC utilisation category:
 - DC13 duty: 1.5A 24V (10A 24V only for PLN-P2L)
 - AC15 duty: 6A 250V (3A 400V only for PLN-P2L)
- IEC conventional thermal current Ith: 10A for RS and PLN; 6A for P2L
- IEC rated insulation voltage Ui: 250VAC (400V for PLN-P2L)
- Contact resistance: <10mΩ
- Short-circuit backup protection: 10A gG/SC quick fuse
- Cable entry: PG11 for RS, PLN and P2L types (PLN and P2L complete with cable gland)
- Cable connection: self-releasing screw terminal
- Tightening torque:
 - Switch fixing: 2.5Nm / 22.1lb.in
 - Contact terminals: 0.8Nm / 7lb.in (for RS), 1.8Nm / 15.9lb.in (for PL and P2L)
 - Body lid screw fixing: 0.8Nm / 7lb.in
- Conductor section: 1 or 2 2.5mm² max / 16-14 AWG
- Ambient conditions:
 - Operating temperature: -25...+70°C
 - Storage temperature: -40...+70°C
 - Pollution degree: 3
 - IEC degree of protection: IP65.

Operation

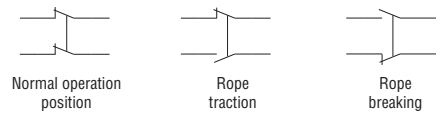

Certification and compliance

Certifications obtained: UL Listed for USA and Canada (cULus - File E93601), as Auxiliary Devices - Limit switches for RS13... types only; EAC for all.
Compliant with standards: IEC/EN/BS 60947-1, IEC/EN/BS 60947-5-1, IEC/EN/BS 60204-1, ISO 13850; also UL508, CSA-C22.2 n° 14 for RS types.

Safety switches with solenoid



KEN1...

Order code	Key actuated contacts ①	Solenoid actuated contacts ①	Solenoid rated voltage [V]	Qty per pkg n°	Wt [kg]
Locked actuator with energised solenoid ②					
KEN1E1024F	1NC	2NC+1NO	24V AC/DC	1	0.440
KEN1E2024F	1NA	2NC+1NO		1	0.440
KEN1E3024F	1NO+1NC	2NC		1	0.440
KEN1E1120F	1NC	2NC+1NO	120V AC/DC	1	0.440
KEN1E2120F	1NO	2NC+1NO		1	0.440
KEN1E3120F	1NO+1NC	2NC		1	0.440
KEN1E1230F	1NC	2NC+1NO	230V AC/DC	1	0.440
KEN1E2230F	1NO	2NC+1NO		1	0.440
KEN1E3230F	1NO+1NC	2NC		1	0.440
Locked actuator with de-energised solenoid ②					
KEN1M1024F	1NC	2NC+1NO	24V AC/DC	1	0.440
KEN1M2024F	1NO	2NC+1NO		1	0.440
KEN1M3024F	1NO+1NC	2NC		1	0.440
KEN1M1120F	1NC	2NC+1NO	120V AC/DC	1	0.440
KEN1M2120F	1NO	2NC+1NO		1	0.440
KEN1M3120F	1NO+1NC	2NC		1	0.440
KEN1M1230F	1NC	2NC+1NO	230V AC/DC	1	0.440
KEN1M2230F	1NO	2NC+1NO		1	0.440
KEN1M3230F	1NO+1NC	2NC		1	0.440

① Contacts status are referred to the operating condition (KEN1E...energised solenoid and inserted key actuator / KEN1M... de-energised solenoid and inserted key actuator).

② Key actuator has to be ordered separately

Keys



KEXN1



KEXN2



KEXN5

Order code	Description	Qty per pkg n°	Wt [kg]
KEXN1	Straight key	1	0.013
KEXN2	Angled key	1	0.013
KEXN5	Toggle key	1	0.019

ACTUATOR HAED ORIENTATION



Follow these steps in order to properly direct the actuator head of KEN... safety switches:

- Unscrew the 4 Ø2 Pozidriv 1 screws
- Remove the actuator
- Check the gasket is properly placed
- Put the actuator head in the desired position and press for fixing it into the case
- Screw the the 4 Ø2 Pozidriv 1 screws (tightening torque 0.8Nm / 7lb.in)
- Before start using the new configuration, repeat the functional tests of the system.

General characteristics

The safety switches with solenoid avoid access in hazardous areas until the receiving of an appropriate signal: the actuator key could be locked or released through a solenoid dependent upon it's powered state (locked actuator with energised solenoid for KEN1E... /locked actuator with de-energised solenoid for KEN1M...).

A manual emergency release is available.

Three different electric contact combinations are available. Contacts are actuated separately by key actuator or by solenoid and allow to cover the installations' main common needs.

Operational characteristics

- For safety applications up to:
 - Safety integrity level (SIL), category 3 according to EN/BS 62061
 - PLe according to EN/BS ISO 13849-1
- Interlock with mechanical lock Type 2 according to EN/BS ISO 14119.
- Actuator insertion force: 15N
- Release actuator extraction force: 30N
- Locked actuator holding force: 1200N
- Maximum operating rate: 600 cycles/h
- Mechanical life: 1.000.000 cycles
- B10d: 4.000.000 cycles
- IEC conventional thermal current: 10A
- IEC/EN/BS 60947-5-1 designation: A300 Q300
- AC15 duty:
 - 24V - 10A
 - 230V - 4A
- DC13 duty:
 - 24V - 4A
- IEC rated insulation voltage Ui: 250V
- Rated impulse withstand voltage: 2.5kV
- Short-circuit backup protection: 10A Gg
- Max solenoid consumption:
 - 24V: 8.3W
 - 120V: 8.1W
 - 230V: 6.8W
- IEC terminals degree of protection: IP20
- IEC body housing degree of protection: IP65
- Self-extinguishing polymer thermoplastic housing and actuator head
- Actuator head orientation can be modified by the user in 4 axial positions (90° step)
- Cables entries: 3 x M20
- Cable connection: self-releasing screw terminal
- Tightening torque:
 - Case cover: 0.8Nm / 7lb.in
 - Manual release: 0.5Nm / 4.3lb.in
 - Head actuator fixing: 0.8Nm / 7lb.in
 - Contact terminals: 0.5Nm / 4.3lb.in
 - Supply terminals: 0.5Nm / 4.3lb.in
- Conductor section: 1 or 2 conductors 1.5mm² max
- Ambient conditions:
 - Operating temperature: -25...+55°C
 - Storage temperature: -40...+70°C
 - Pollution degree: 3.

Certifications and compliance

Certifications obtained: cULus, EAC.
Compliant with standards: IEC/EN/BS 60947-1, IEC/EN/BS 60947-5-1, IEC/EN/BS 60204, UNI EN/BS ISO 14119, UL508, CSA C22.2 n°14.

9 Limit, micro and foot switches

Safety switches with solenoid and separate actuator

Key actuator status	KEN1E...: locked actuator with energised solenoid			KEN1M...: locked actuator with de-energised solenoid		
	inserted and locked	inserted and unlocked	not inserted	inserted and locked	inserted and unlocked	not inserted
Solenoid status	energised	de-energised	-	de-energised	energised	-

Contact activation

KEN1...1...	Key actuator	11 12	11 12	11 12	11 12	11 12	11 12
	Solenoid	21 22	21 22	21 22	21 22	21 22	21 22
	Solenoid	33 34	33 34	33 34	33 34	33 34	33 34
	Solenoid	41 42	41 42	41 42	41 42	41 42	41 42
KEN1...2...	Key actuator	13 14	13 14	13 14	13 14	13 14	13 14
	Solenoid	21 22	21 22	21 22	21 22	21 22	21 22
	Solenoid	33 34	33 34	33 34	33 34	33 34	33 34
	Solenoid	41 42	41 42	41 42	41 42	41 42	41 42
KEN1...3...	Key actuator	13 14	13 14	13 14	13 14	13 14	13 14
	Solenoid	21 22	21 22	21 22	21 22	21 22	21 22
	Key actuator	31 32	31 32	31 32	31 32	31 32	31 32
	Solenoid	41 42	41 42	41 42	41 42	41 42	41 42

9 Limit, micro and foot switches

Plastic micro switches.
Accessories



KSA1...

KSA2...



KSA3...

KSA4...

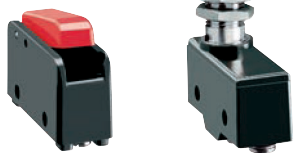

KSA9...

KSB1...

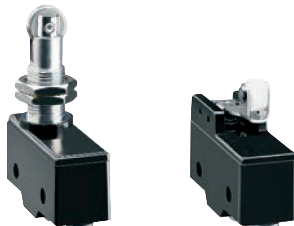

KSB2...

KSC1...

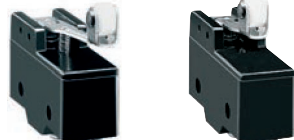

KSC2...

KSC3...

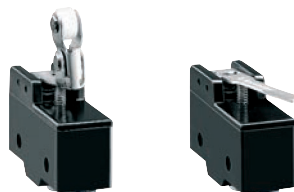

KSC9...

KSL1...

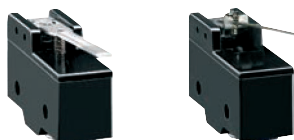

KSL2...

KSL3...

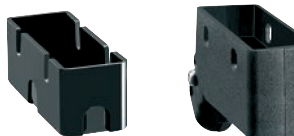

KSSC01

KSSCB2

Order code	Contacts	Terminals	Qty per pkg	Wt
			n°	[kg]
TOP PUSH ROD. METAL PLUNGER. Pin.				
KSA1S	1NO/NC	Solder	10	0.031
KSA1V	1NO/NC	Screw	10	0.031
KSA1F	1NO/NC	Faston	10	0.032
TOP PUSH ROD. METAL PLUNGER. High rod plunger.				
KSA2S	1NO/NC	Solder	10	0.033
KSA2V	1NO/NC	Screw	10	0.033
KSA2F	1NO/NC	Faston	10	0.034
TOP PUSH ROD. METAL PLUNGER. Low rod plunger.				
KSA3S	1NO/NC	Solder	10	0.033
KSA3V	1NO/NC	Screw	10	0.033
KSA3F	1NO/NC	Faston	10	0.035
TOP PUSH ROD. METAL PLUNGER. M12 fixing head.				
KSA4S	1NO/NC	Solder	10	0.052
KSA4V	1NO/NC	Screw	10	0.052
KSA4F	1NO/NC	Faston	10	0.053
PUSH BUTTON.				
KSA9S	1NO/NC	Solder	10	0.034
KSA9V	1NO/NC	Screw	10	0.034
KSA9F	1NO/NC	Faston	10	0.035
TOP ROLLER PUSH PLUNGER. M12 fixing head.				
KSB1S	1NO/NC	Solder	10	0.057
KSB1V	1NO/NC	Screw	10	0.057
KSB1F	1NO/NC	Faston	10	0.058
TOP ROLLER PUSH PLUNGER. M12 fixing head, 90° roller.				
KSB2S	1NO/NC	Solder	10	0.057
KSB2V	1NO/NC	Screw	10	0.057
KSB2F	1NO/NC	Faston	10	0.060
ROLLER CENTRE PUSH LEVER. 26.6mm/1.05" long lever.				
KSC1S	1NO/NC	Solder	10	0.036
KSC1V	1NO/NC	Screw	10	0.036
KSC1F	1NO/NC	Faston	10	0.037
ROLLER CENTRE PUSH LEVER. 48.5mm/1.91" long lever.				
KSC2S	1NO/NC	Solder	10	0.037
KSC2V	1NO/NC	Screw	10	0.037
KSC2F	1NO/NC	Faston	10	0.038
ROLLER CENTRE PUSH LEVER. 37mm/1.45" long lever.				
KSC3S	1NO/NC	Solder	10	0.037
KSC3V	1NO/NC	Screw	10	0.037
KSC3F	1NO/NC	Faston	10	0.038
ROLLER CENTRE PUSH LEVER. One-way roller lever.				
KSC9S	1NO/NC	Solder	10	0.038
KSC9V	1NO/NC	Screw	10	0.038
KSC9F	1NO/NC	Faston	10	0.039
METAL LEVER. 63mm/2.48" long flat lever.				
KSL1S	1NO/NC	Solder	10	0.035
KSL1V	1NO/NC	Screw	10	0.035
KSL1F	1NO/NC	Faston	10	0.037
METAL LEVER. 54mm/2.13" long flat lever.				
KSL2S	1NO/NC	Solder	10	0.035
KSL2V	1NO/NC	Screw	10	0.035
KSL2F	1NO/NC	Faston	10	0.037
METAL LEVER. 168.3mm/6.63" long flat cylindrical lever.				
KSL3S	1NO/NC	Solder	10	0.037
KSL3V	1NO/NC	Screw	10	0.037
KSL3F	1NO/NC	Faston	10	0.038
ACCESSORIES. ❶				
KSSC01	Terminal shroud		10	0.007
KSSCB2	Terminal shroud with conduit		10	0.015

❶ Suitable only for KS...V.

Operational characteristics

- Maximum operating rate: 240 cycles/min
- Switching speed: 0.01...1m/s
- Operating speed: 0.05...1m/s
- Electrical life: 500,000 cycles
- Mechanical life: 20 million cycles
- IEC conventional thermal current Ith: 15A
- UL/CSA and IEC/EN/BS 60947-5-1 designation: A600 P300
- Conductivity: 10mA 5V
- IEC rating: AC15 240VAC 3A
- IEC rated insulation voltage Ui: 250VAC
- Contact resistance: <15mΩ
- Body housing: polymer thermoplastic
- Operating force:
 - KSA1-KSA4 and KSB types: 2.5N/9oz
 - KSA9 and KSC3 types: 1.5N/5.4oz
 - KSC1 types: 1N/3.6oz
 - KSC2 and KSL2: 1.3N/4.7oz
 - KSC9 types: 1.7N/6.1oz
 - KSL1 types: 6.4N/23oz
 - KSL3 types: 0.1N/0.36oz
- Tightening torque:
 - For M12 head fixing: 4.9...6.9Nm/43...61lb.in
 - For side screws: 0.6...1Nm/5.3...8.8lb.in
 - For terminal screws: 0.7...1Nm/6.2...8.8lb.in
- Ambient conditions:
 - Operating temperature: -25...+70°C
 - Storage temperature: -40...+70°C
 - Pollution degree: 3
 - IEC degree of protection: IP00 or IP20 with terminal shroud.

Certifications and compliance

Certifications obtained: UL Recognized for USA and Canada (File E172189) as Industrial Control Switches - Component; products having this type of marking are intended for use as components of complete workshop - assembled equipment; EAC.
Compliance with standards: IEC/EN/BS 60947-1, IEC/EN/BS 60947-5-1, IEC/EN/BS 61058-1, UL508, CSA C22.2 n° 14.

9 Limit, micro and foot switches

Foot switches.
Accessories



KG200 ...
KG220 ...



KR200 ...



KG110 ...



KR210 ...
KR211 ...

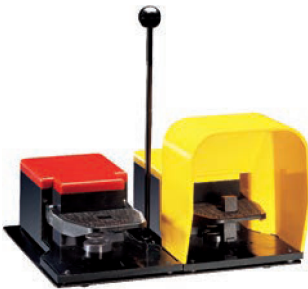

KGD003 - KGD004

- ① Direct (positive) opening action \ominus ; safety function according to IEC/EN/BS 60947-5-1.
- ② Consult Technical support for information; see contact details on inside cover.
- ③ A possible second contact block can be fitted; blocks with only 2 contacts in total can be used. See accessories below.

Accessories



KXP...



KXP03

- ④ A possible second contact block can be fitted on the left-hand pedal; blocks with only 2 contacts in total can be used. See accessories below and contact blocks on page 9-16.

Order code Plastic body	Metal body	Model	Contacts	Qty per pkg	Wt
				n°	[kg]

ONE PEDAL FOOT SWITCHES. With free actuation.

KG100S11 ③	KR100S11 ③	Open	1NO+1NC Snap action ①	1	②
KG100L11 ③	KR100L11 ③	Open	1NO+1NC Slow action ①	1	②
KG200S11 ③	KR200S11 ③	With cover	1NO+1NC Snap action ①	1	②
KG200L11 ③	KR200L11 ③	With cover	1NO+1NC Slow action ①	1	②

With safety lever.

KG110S11 ③	KR110S11 ③	Open	1NO+1NC Snap action ①	1	②
KG110L11 ③	KR110L11 ③	Open	1NO+1NC Slow action ①	1	②
KG210S11 ③	KR210S11 ③	With cover	1NO+1NC Snap action ①	1	②
KG210L11 ③	KR210L11 ③	With cover	1NO+1NC Slow action ①	1	②
KG210S22 ③	KR210S22 ③	With cover	2NO+2NC Snap action ①	1	②

With pedal actuator lock.

KG120S11 ③	KR120S11 ③	Open	1NO+1NC Snap action ①	1	②
KG120L11 ③	KR120L11 ③	Open	1NO+1NC Slow action ①	1	②
KG220S11 ③	KR220S11 ③	With cover	1NO+1NC Snap action ①	1	②
KG220L11 ③	KR220L11 ③	With cover	1NO+1NC Slow action ①	1	②

With two-stage safety lever.

KG211S22 ③	KR211S22 ③	With cover	2NO+2NC 2-stage snap action ①	1	②
---------------	---------------	---------------	-------------------------------------	---	---

Order code Plastic body	Metal body	Model	Contacts (for each pedal)	Qty per pkg	Wt
				n°	[kg]

TWO PEDAL FOOT SWITCHES. With safety lever on both pedals.

KGD001 ③	KRD001 ③	Both w/cover	1NO+1NC Snap action ①	1	②
KGD002 ③	KRD002 ③	Both w/cover	2NO+2NC Snap action ①	1	②

Left pedal with free actuation and right pedal with safety lever.

KGD003 ③	KRD003 ③	Left open Right w/cover	1NO+1NC Snap action ①	1	②
KGD004 ④	KRD004 ④	Left open Right w/cover	1NO+1NC Snap action ① 2NO+2NC Snap action ①	1	②

General characteristics

The KG... and KR... foot switches are used to control machinery and other equipment, leaving the operator's hands free to do other functions. The sturdiness of the metal and plastic body and the wide range of the available versions provide the proper solution for each control need.

Main features are:

- Thermoplastic or metal version.
The plastic or metal body gives adequate robustness to the foot switch, for installation in all ambient and application conditions.
- Versions complete with or without pedal protection cover.
The cover assures protection against accidental foot switch operation, due to sudden tool or heavy material dropping or other shock or vibration. The type without cover, open version, is instead immediately accessible and is preferred when the most important pedal operation is to stop a machine.
- Versions with safety lever.
The safety mechanism prevents unintentional foot switch activation and excludes the pedal pressing if the operator's foot is not completely in place.
- Stable pedal base.
The foot switch is equipped with rubber feet and metal-reinforced base for a firm and non-sliding position and a more reliable and safe activation.

Operational characteristics

- Mechanical life: >10 million cycles
- Conventional thermal current Ith: 10A
- Designation to IEC/EN/BS 60947-5-1:
 - A600 Q600 for KG types
 - A300 Q300 for KR types
- Tightening torque for contacts: 1Nm/8.8lb.in
- Rated insulation voltage Ui:
 - 690VAC for KG types
 - 440VAC for KR types
- Rated impulse withstand voltage Uimp:
 - 6kV for KG types
 - 4kV for KR types
- Class II insulation (KG types only)
- Contact resistance: <10mΩ
- Short-circuit backup protection: 10A gG fuse
- Cable connection: self-releasing screw terminal
- Housing:
 - KG types: self-extinguishing double-insulation polymer thermoplastic
 - KR types: aluminium-zinc alloy
- Cable entry: M20
- Ambient conditions:
 - Operating temperature: -25...+70°C
 - Storage temperature: -40...+70°C
 - Pollution degree: 3
- IEC degree of protection:
 - IP20 for terminals
 - IP54 for body housing
 - IP65 available on request (add the letter S at the end of the order code. E.g. KG100S11S).

Certifications and compliance

Certifications obtained: cURus for contacts only and EAC for foot switches.

Compliant with standards: IEC/EN/BS 60947-1, IEC/EN/BS 60947-5-1, IEC/EN/BS 60204-1, IEC/EN/BS 60447.

General characteristics

The cable glands are in plastic with either M20 or PG13.5 thread and provide to keep the cable in place and maintain the proper IP protection of the switch after installation.

Operational characteristics for cable gland

- Material: self-extinguishing polyamide
- IEC degree of protection: IP68
- Gland seal with cable diameter: 6...12mm/0.24" ..0.47".

Certifications and compliance

Certifications obtained: EAC.
Compliant with standards: EN/BS 50262, UL508.

Order code	Description	Qty per pkg	Wt
		n°	[kg]

Accessories.

KGX01	Kit of elements to activate 2° contact block ④	10	0.039
KGX02	Contact block mounting bracket	10	0.022

Cable glands and cable conduit.

KXP01	M20 cable gland	50	0.009
KXP02	PG13.5 cable gland	50	0.009
KXP03	M20 rubber cable conduit	50	0.004

9 Limit, micro and foot switches

Dimensions [mm (in)]

LIMIT SWITCHES K SERIES

**KBA1...
KMA1...**

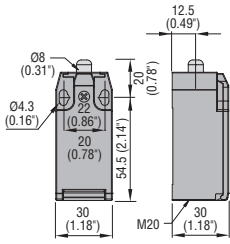

**KCA1
KNA1**

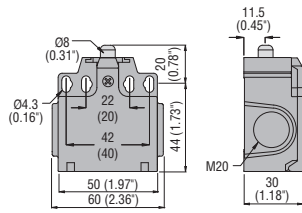

**KBB1... - KBB2...
KMB1... - KMB2...**

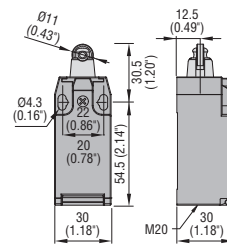

**KCB1... - KCB2...
KNB1... - KNB2...**

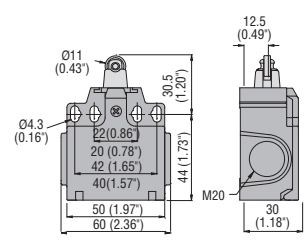

**KBC1... - KBC2...
KMC1... - KMC2...**

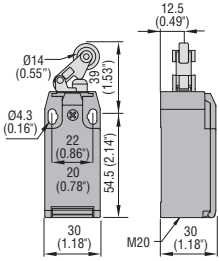

**KCC1... - KCC2...
KNC1... - KNC2...**

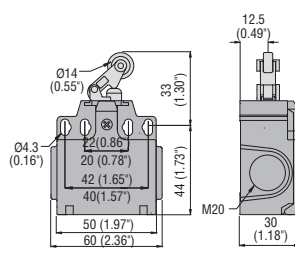

**KBD1... - KBD2...
KMD1... - KMD2...**

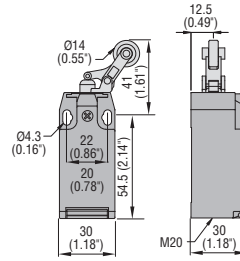

**KCD1... - KCD2...
KND1... - KND2...**

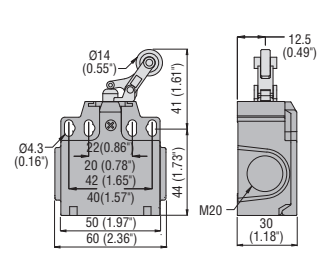

**KBE1... - KBE2...
KME1... - KME2...**

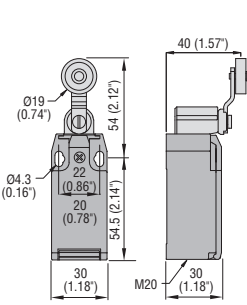

**KCE1... - KCE2...
KNE1... - KNE2...**

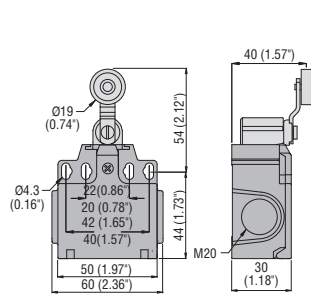

**KBE3...
KME3...**

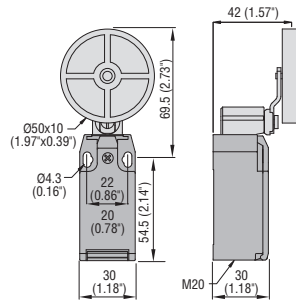

**KCE3...
KNE3...**

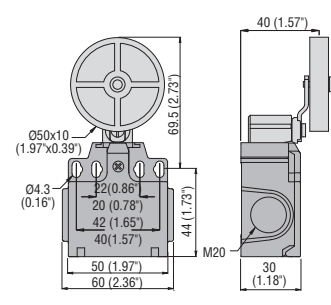

**KBF1... - KBF2...
KMF1... - KMF2...**

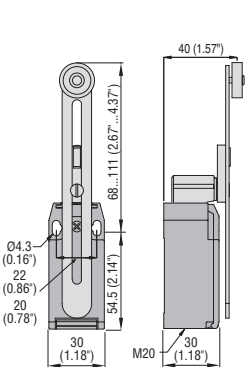

**KCF1... - KCF2...
KNF1... - KNF2...**

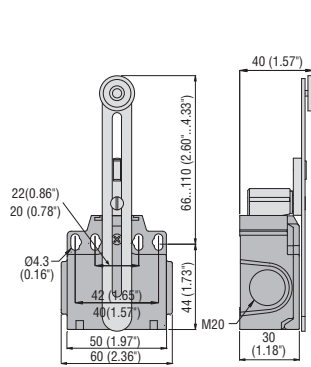

**KBF3...
KMF3...**

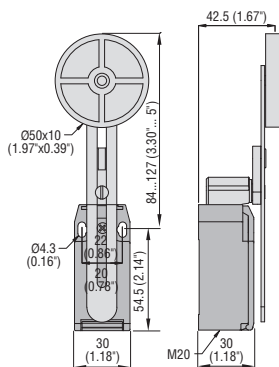

**KCF3...
KNF3...**

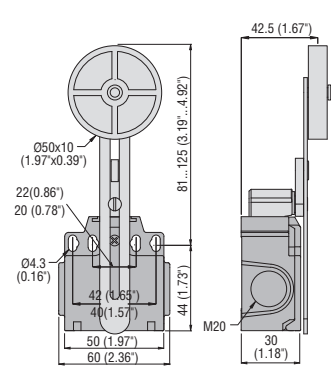

**KBF4...
KMF4...**

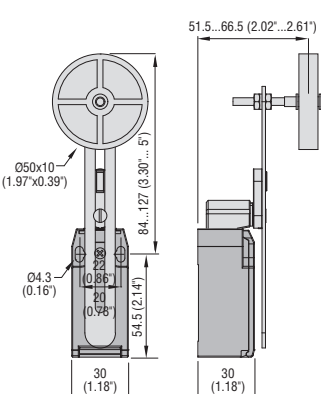

**KCF4...
KNF4...**

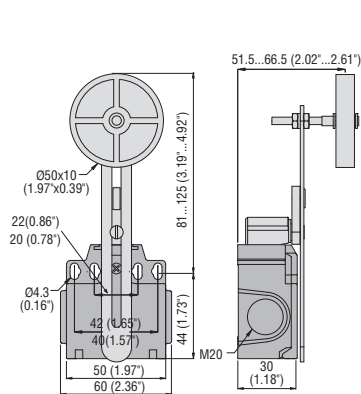

**KBH1...
KMH1...**

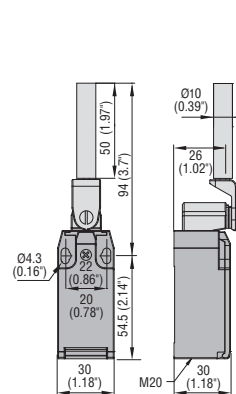

**KCH1...
KNH1...**

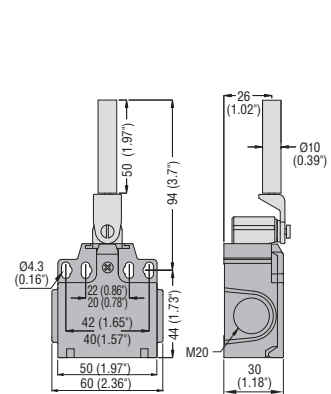

9 Limit, micro and foot switches

Dimensions [mm (in)]

LIMIT SWITCHES K SERIES

KBL1... - KBL2...
KML1... - KML2...

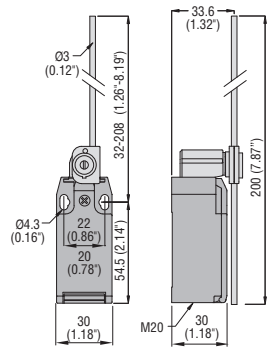

KCL1... - KCL2...
KNL1... - NNL2...

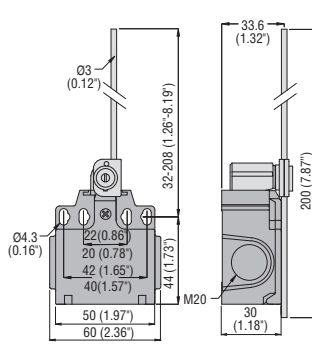

KBM1... - KBM2...
KMM1... - KMM2...

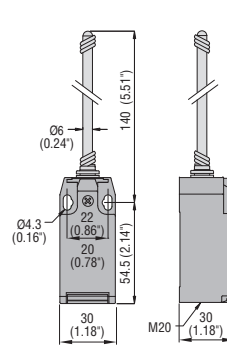

KCM1... - KCM2...
KNM1... - KNM2...

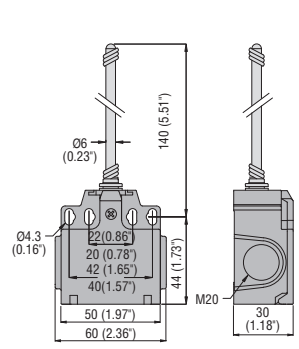

KBP1...
KMP1...

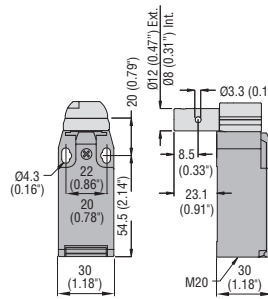

KBP2...
KMP2...

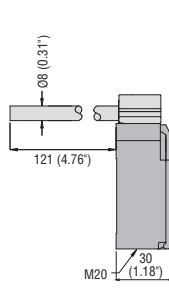

KBP3...
KMP3...

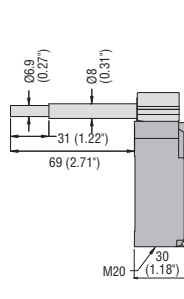

KCP1...
KNP1...

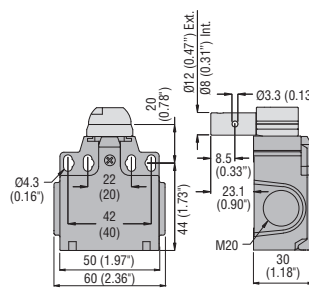

KCP2...
KNP2...

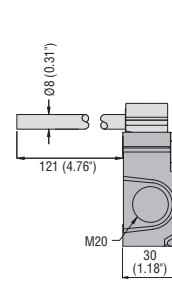

KCP3...
KNP3...

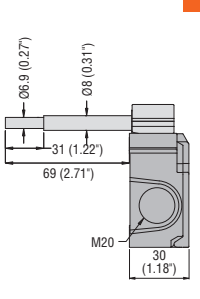

KBQ1L...
KMQ1L...

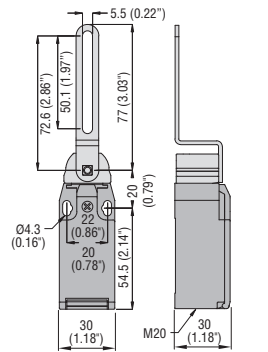

KCQ1L...
KNQ1L...

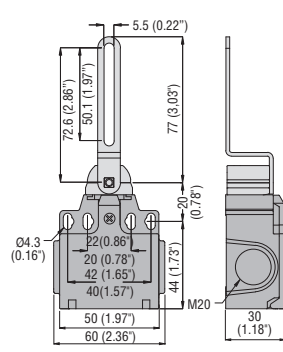

KBN1... - KBN2...
KMN1... - KMN2...

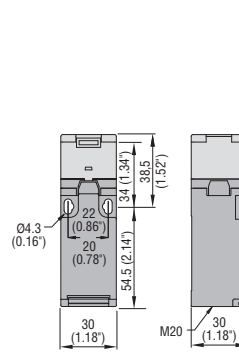

KCN...

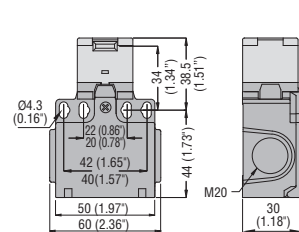

Keys

KXN1

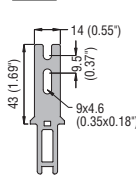

KXN2

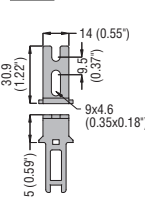

KXN3

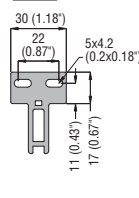

KXN4

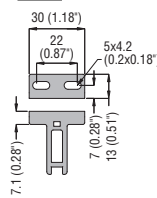

KXN5

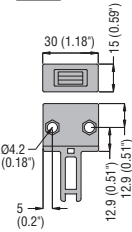

Cable glands

KXP01

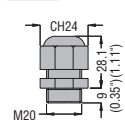

KXP02

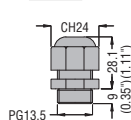

Cable conduit

KXP03

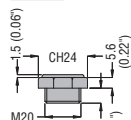

CH = Spanner/Wrench

CH = Spanner/Wrench

CH = Spanner/Wrench

PREWIRED METAL LIMIT SWITCHES

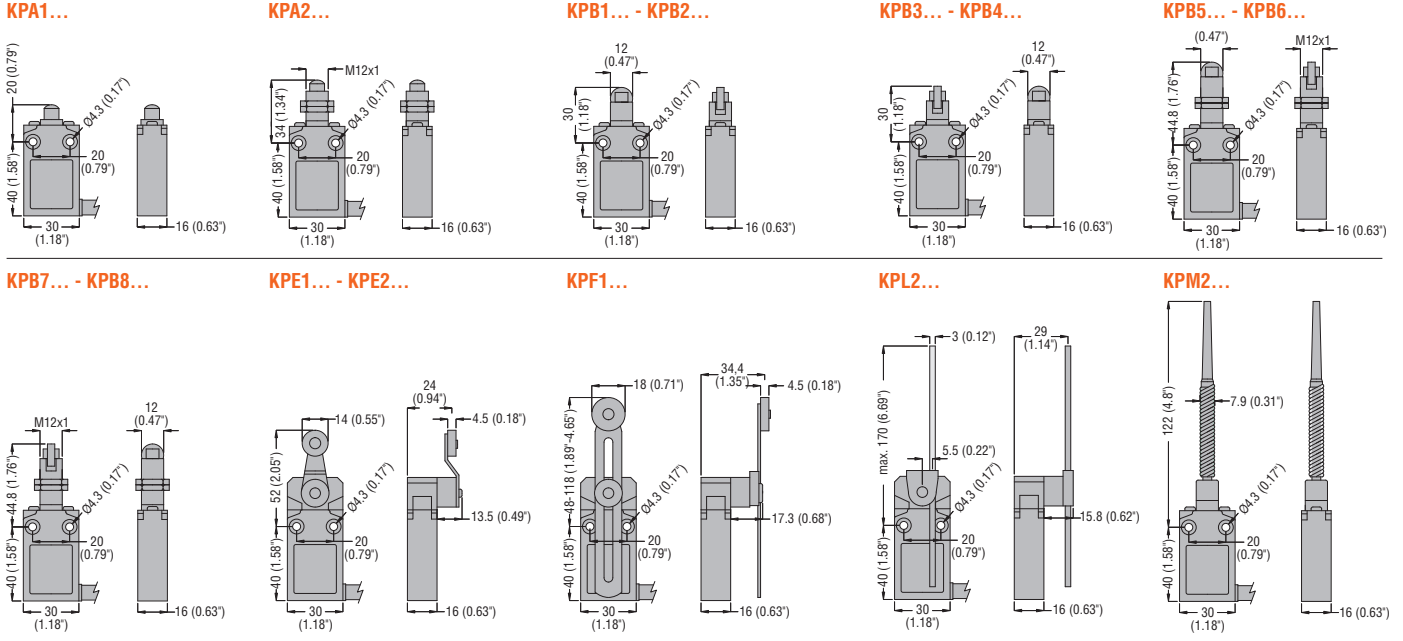

9 Limit, micro and foot switches

Dimensions [mm (in)]

METAL LIMIT SWITCHES, PL SERIES

PLN...A

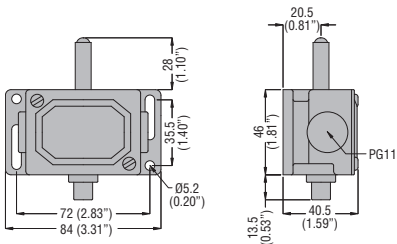

PLN...AW

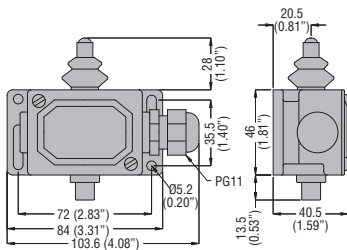

PLN...R

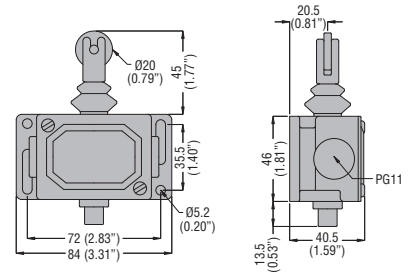

PLN...RW

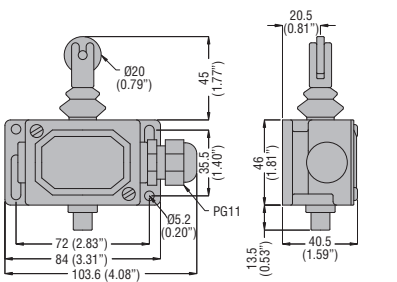

PLN...H

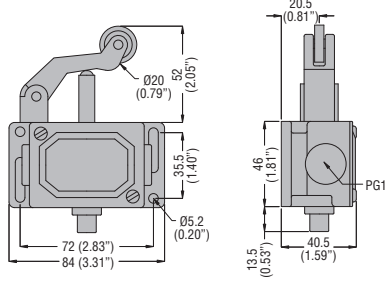

PLN...HW

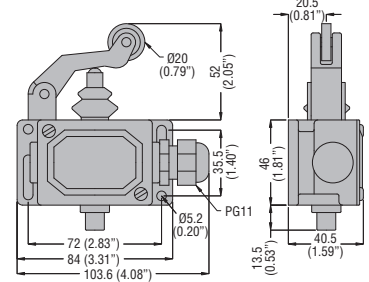

PLN...HSB

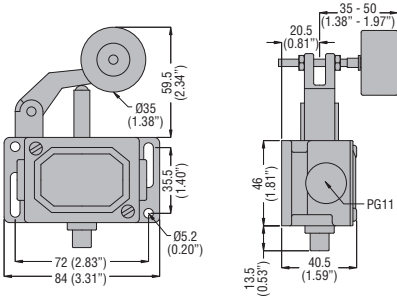

PLN...HSBW

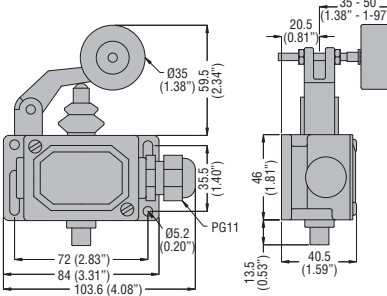

PLNA1RAG

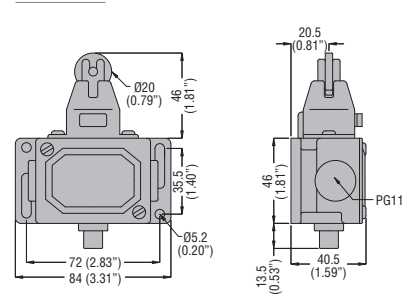

PLNA1RAGW

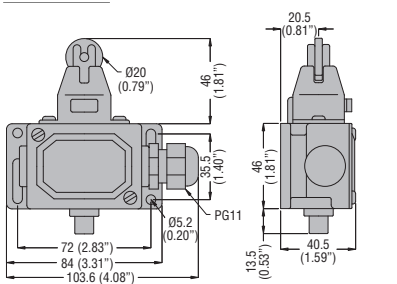

PLNA1AM

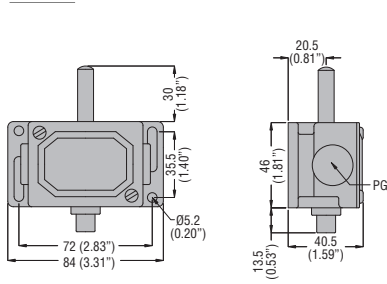

PLA1AMW

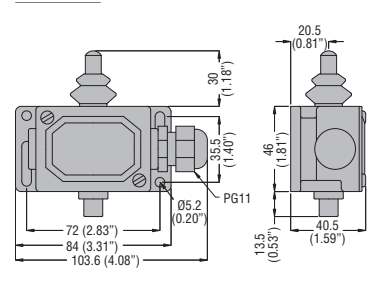

PLA1RM

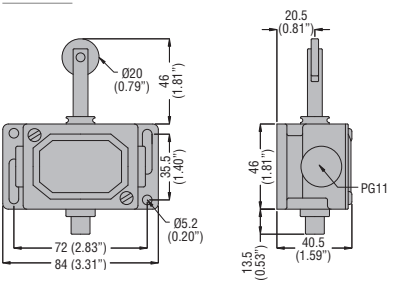

PLA1RMW

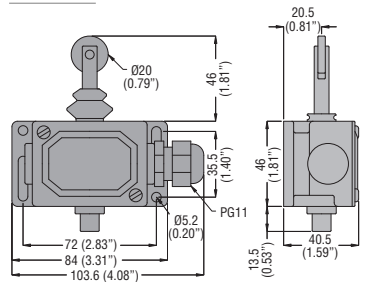

PLN978

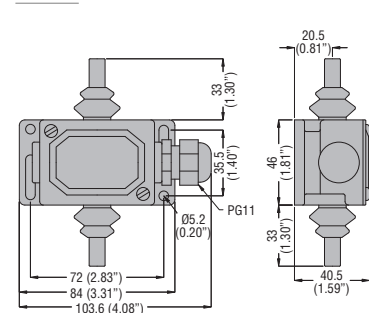

9 Limit, micro and foot switches

Dimensions [mm (in)]

ROPE-PULL LEVER LIMIT SWITCHES FOR NORMAL STOPPING

RS113... - RS313...

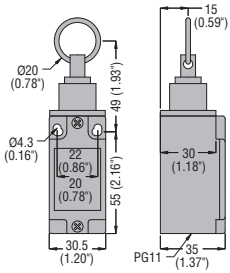

PLN...AT

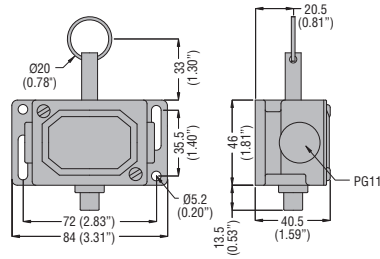

PLN...ATW

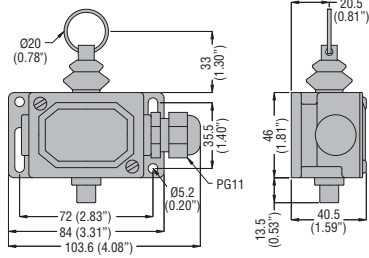

P2L...

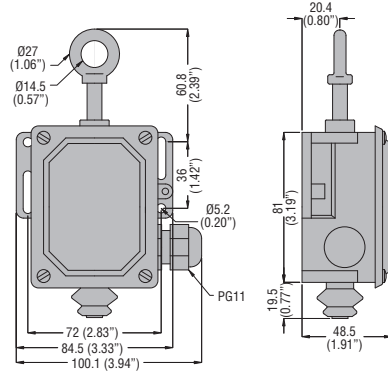

ROPE-PULL SAFETY LIMIT SWITCHES, ISO 13850 COMPLIANT

RS131310

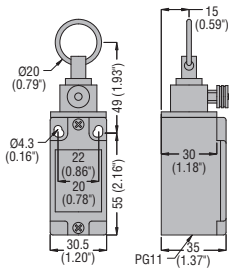

PLN131311

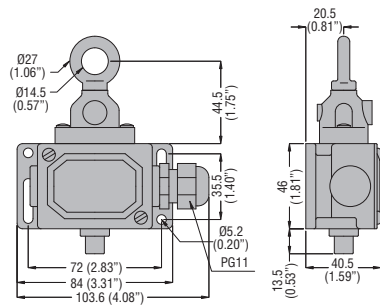

P2L13... - P2L15...

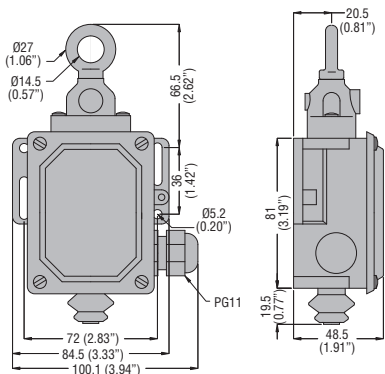

9 Limit, micro and foot switches

Dimensions [mm (in)]

SAFETY SWITCHES WITH SOLENOID

KEN1...

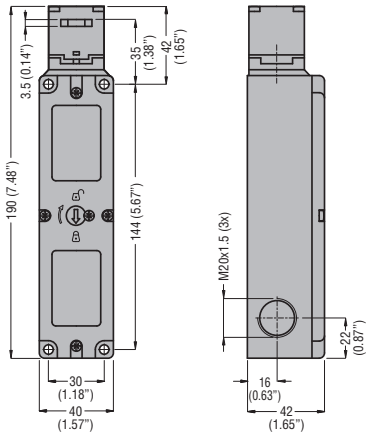

KEXN1

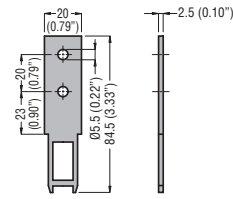

KEXN2

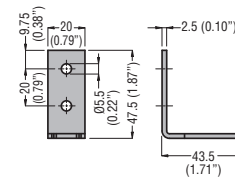

KEXN5

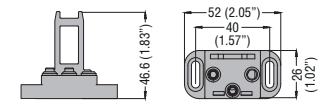

PLASTIC MICRO SWITCHES

KSA1...

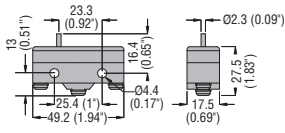

KSA2...

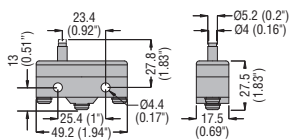

KSA3...

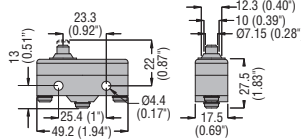

KSA4...

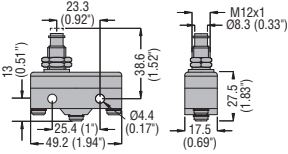

KSA9...

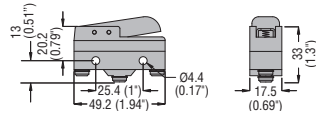

KSB1...

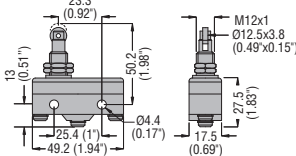

KSB2...

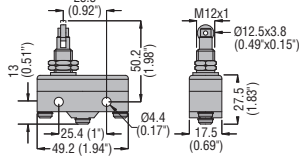

KSC1...

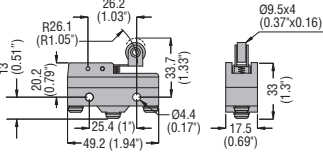

KSC2...

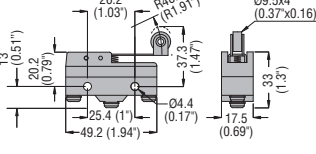

KSC3...

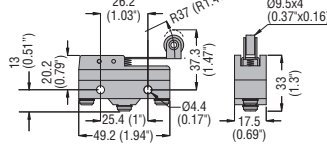

KSC9...

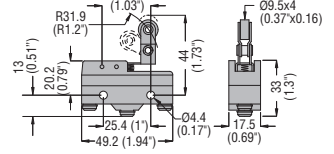

KSL1...

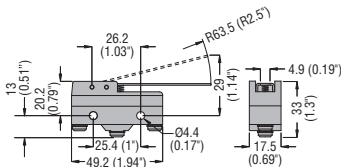

KSL2...

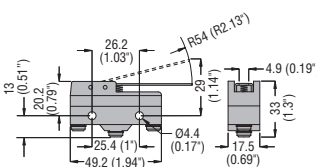

KSL3...

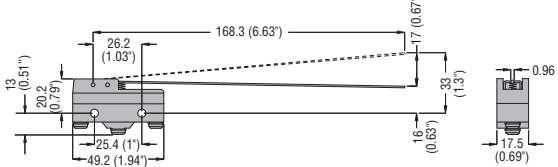

TERMINAL SHROUD

KSSC01

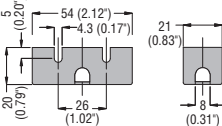

KSSCB2

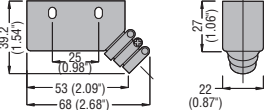

9 Limit, micro and foot switches

Dimensions [mm (in)]

FOOT SWITCHES

KG1

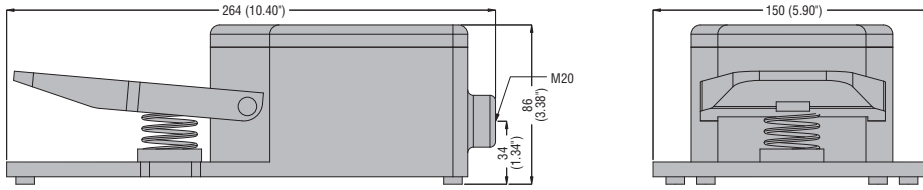

KG2

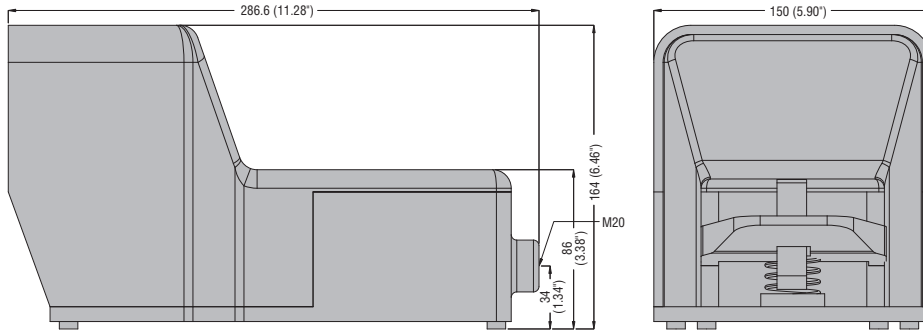

KR1

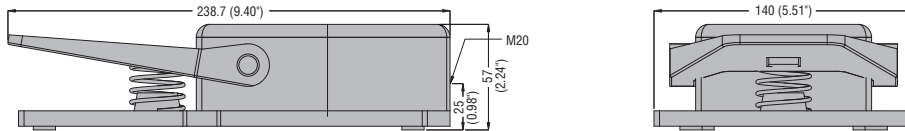

KR2

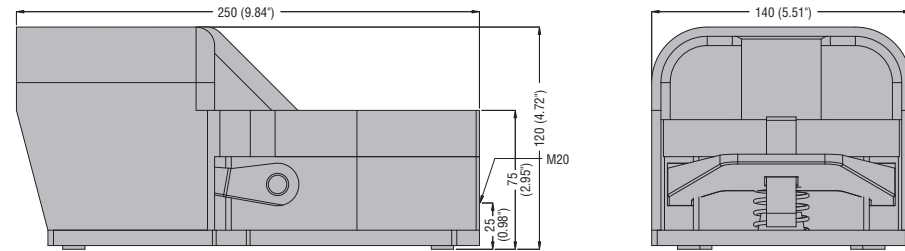

KGD

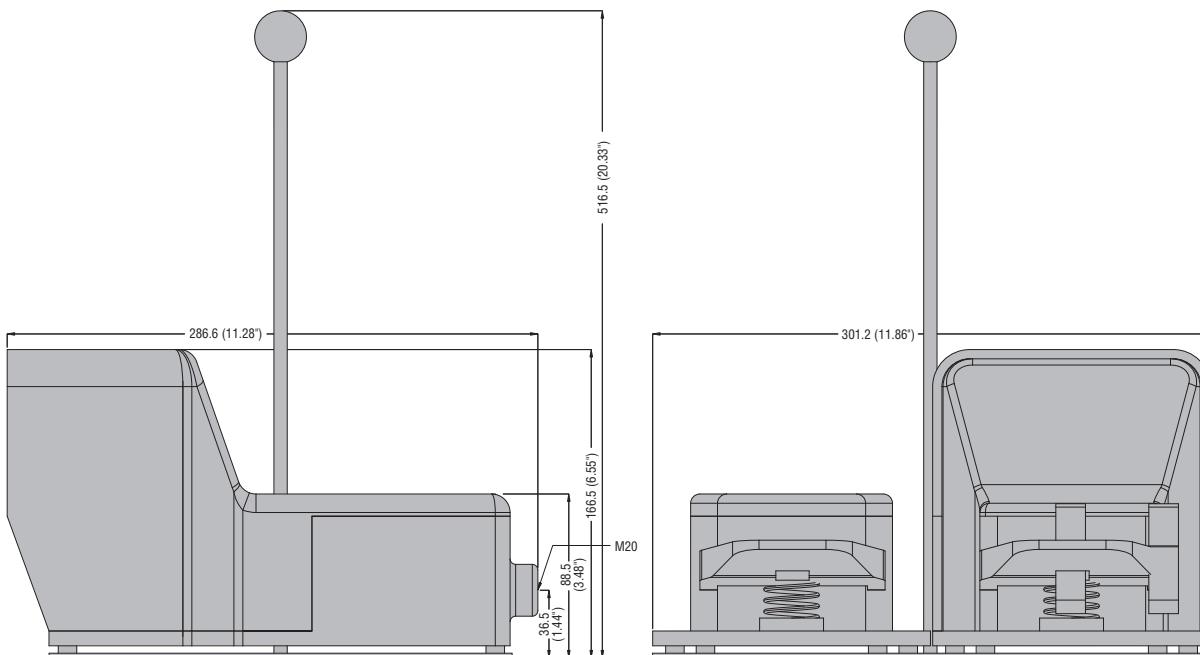

LIMIT SWITCHES, KB - KM - KC - KN TYPES

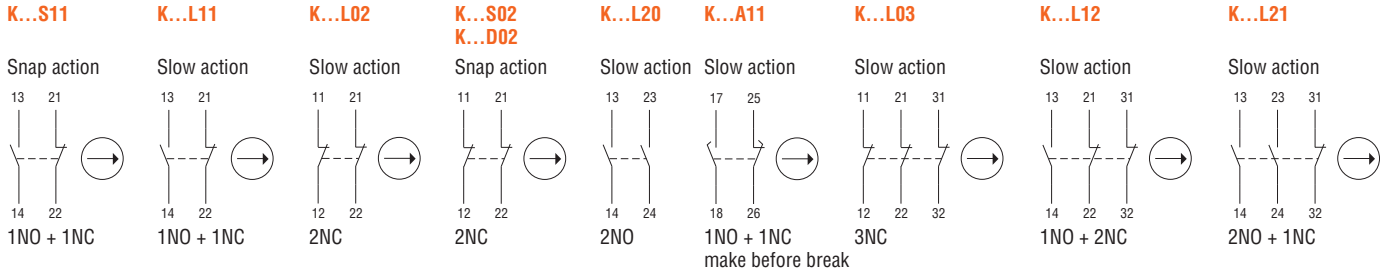

PREWIRED METAL LIMIT SWITCHES

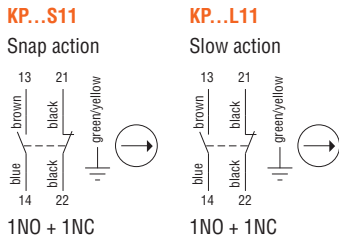

LIMIT SWITCHES, PL TYPE

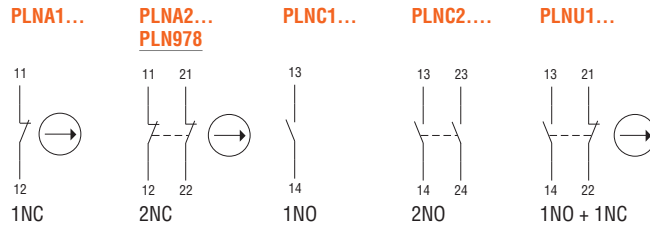

LIMIT SWITCHES FOR NORMAL STOPPING

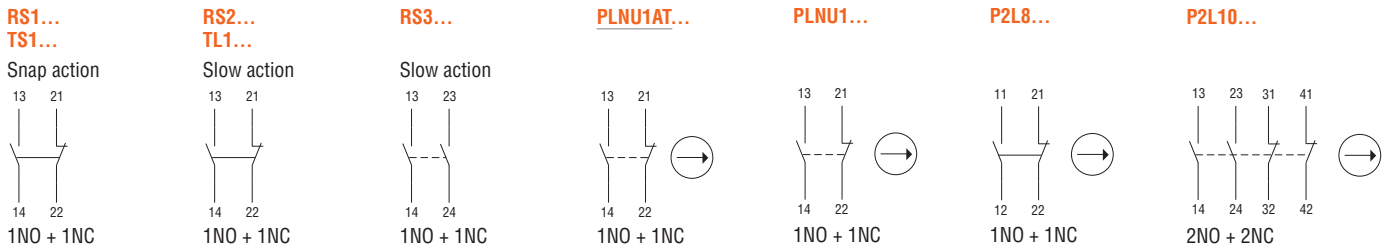

LIMIT SWITCHES FOR EMERGENCY STOPPING

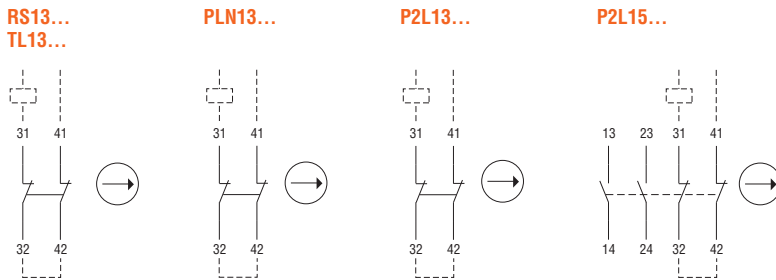

PLASTIC MICRO SWITCHES

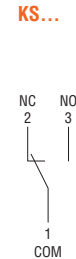

SAFETY SWITCHES WITH SOLENOID

Actuator inserted and unlocked

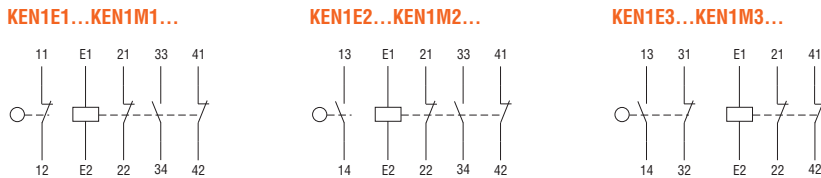

FOOT SWITCHES

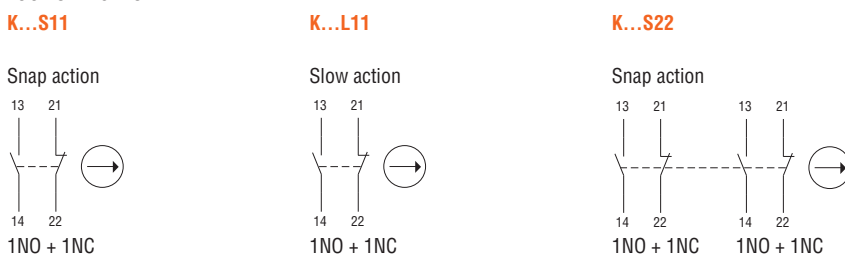

X-ON Electronics

Largest Supplier of Electrical and Electronic Components

Click to view similar products for [Limit Switches](#) category:

Click to view products by [Lovato](#) manufacturer:

Other Similar products are found below :

[LZG1](#) [LZL1-6C](#) [622EN114-R](#) [622EN224-6B](#) [622EN230](#) [622EN237-R](#) [622EN85-RB](#) [7LS51](#) [83547001](#) [83725002](#) [83840001](#) [83840701](#)
[83881130](#) [8AS42](#) [8LS125-4PG](#) [914CE3-3L1](#) [915PA10](#) [91MCE16-P2O](#) [924CE1-T3](#) [924CE1-T9A](#) [924CE31-Y20-X5](#) [924CE31-Y3L1](#) [GL-](#)
[10054](#) [GL-85714](#) [GLDB03C-6](#) [GLZ324](#) [H3141CAKAA](#) [D4GS-N1T-3](#) [E3102BAAAA](#) [1EN329-R](#) [1LS-J50](#) [1LS-J51](#) [201SN1A1](#) [21EN275-](#)
[R2](#) [21EN314-6](#) [221CH54-RB](#) [221CH55-RB](#) [221EN5-R](#) [914CE16-6AN14](#) [924CE19-S3L1](#) [924CE2-T25A](#) [924CE2-Y12](#) [924CE3-S3](#) [SHL-](#)
[W255-01](#) [SHLW255L6MD730M](#) [SHL-W55](#) [9PA42-4](#) [LS-85637](#) [LSA3K1](#) [LSF1A4](#)