

LUCKI CM ELECTRONICS Co.,Ltd



- Features
 - 3.2 x 2.5 x 0.7 MAX. mm of surface mounted quartz crystal units.
 - Excellent reliability characteristics such as heat and mechanical shock.
 - Pb-free and satisfy Ro Hs requirements.
 - Reflow soldering is available.

- Applications
 - Digital Electronics, Consumer Products, Mobile Communications, Bluetooth, Wireless LAN and Automotive

■ Specifications

LK P/N	L327S260U11L
Nominal Frequency	26.000 MHz
Oscillation Mode	<input checked="" type="checkbox"/> Fundamental <input type="checkbox"/> 3rd
Frequency tolerance at 25°C	±10 ppm
Operating temperature range and frequency stability	-40°C~+85°C/±20ppm
Equivalent series resistance	20 Ω
Shunt capacitance	2 pF Max or specify
Load capacitance	20 pF
Drive level (Max.)	10, 100, 300 μW or specify
Insulation resistance	500MΩ Min. at DC 100V
Aging at 25°C	± 2 ppm / year Max
Storage temperature range	-40 ~ +125 °C
Measure instrument	S&A 250B system with PI circuit
Others	

■ Dimensions (unit: mm)

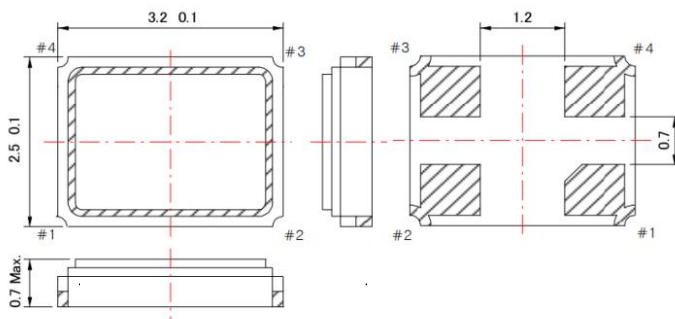

■ Land pattern (unit: mm)

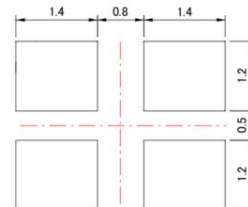

Pin	Function
#1	Xtal Terminal (Input)
#2	GND
#3	Xtal Terminal (Output)
#4	GND

X-ON Electronics

Largest Supplier of Electrical and Electronic Components

Click to view similar products for [Crystals](#) category:

Click to view products by [Lucki](#) manufacturer:

Other Similar products are found below :

[CX3225GB25000M0PPSZ1](#) [718-13.2-1](#) [7A-40.000MAAE-T](#) [FL2000085](#) [99-BU](#) [9B-15.360MBBK-B](#) [9C-7.680MBBK-T](#) [H10S-12.000-18-EXT-TR](#) [ABC2-6.000MHZ-D4Z-T](#) [ABLS-20.000MHZ-D2-T](#) [ABS071-32.768KHZ-6-T](#) [R38-32.768-12.5-5PPM-NPB](#) [BTD1062E05A-513](#) [21U15A-21.4MHZ](#) [RTX-781DF1-S-20.950](#) [LFXTAL066198Cutt](#) [9C-14.31818MBBK-T](#) [A-11.000MHZ-27](#) [ABL-27.000MHZ-B4Y-T](#) [ABM11-132-24.000MHZ-T3](#) [ABM3B1-25.000MHZ-D2Y-T](#) [SPT2A-.032768B](#) [SPT2A.032768G](#) [LFXTAL065253Cutt](#) [LFXTAL066431Cutt](#) [XT9S20ANA14M7456](#) [XT9SNLANA16M](#) [7A-24.576MBBK-T](#) [7B-30.000MBBK-T](#) [CX2520DB16000H0HPQCC](#) [MMCC2R32.7680KHZ](#) [6504-202-1501](#) [6526-202-1501](#) [ABLS-12.000MHZ-B2Y-T](#) [7A-10.000MBBK-T](#) [SG636PCE-20.000MC](#) [3404](#) [CM315D32768EZFT](#) [C1E-24.000-7-2020-R](#) [C1E-19.200-12-1530-X-R](#) [C1E-16.000-12-1530-X-R](#) [ABM11-16.000MHZ-9-B1U-T](#) [FL5000014](#) [EUCA18-3.1872M](#) [FX0800015](#) [425F35E027M0000](#) [FP0800018](#) [MS3V-T1R-32.768kHz-7pF-20PPM-TA-QC-Au](#) [VXM7-1C1-16M000](#) [MS3V-T1R-32.768kHz-9pF-20PPM-TA-QC-Au](#)