

## **S175EVPGC-2B-G51BJ**

2.0x1.25mm, Red & Pure Green LED

Surface Mount Bi-Color Chip LED Indicator

**LuckyLight**

### **Technical Data Sheet**

---

#### **Features:**

- Package in 8mm tape on 7" diameter reel.
- Compatible with automatic placement equipment.
- Compatible with infrared and vapor phase reflow solder process.
- Bi-color type.
- Color: Red & Pure Green.
- The product itself will remain within RoHS compliant Version.

#### **Descriptions:**

- The S175E SMD LED is much smaller than lead frame type components, thus enable smaller board size, higher packing density, reduced storage space and finally smaller equipment to be obtained.
- Besides, lightweight makes them ideal for miniature applications, etc.

#### **Applications:**

- Backlighting in dashboard and switch.
- Telecommunication: Indicator and backlighting in telephone and fax.
- Flat backlight for LCD, switch and symbol.
- General use.

# S175EVPGC-2B-G51BJ

2.0x1.25mm, Red & Pure Green LED

Surface Mount Bi-Color Chip LED Indicator

## Technical Data Sheet

Part No.	Emitting Color	Lens Color
S175EVPGC-2B-G51BJ	V Red	Water Clear
	PG Pure Green	

### Package Dimension:

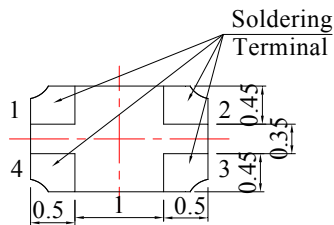
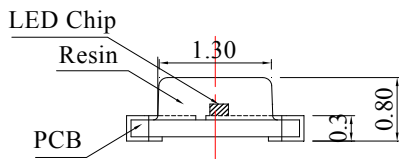
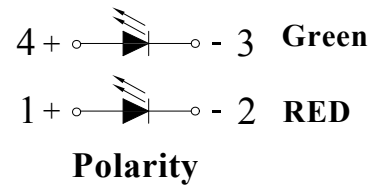
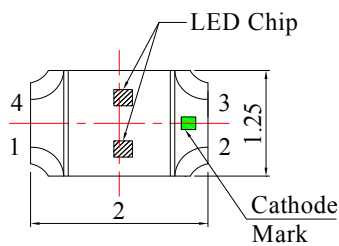

### Recommended Soldering Pad Dimensions

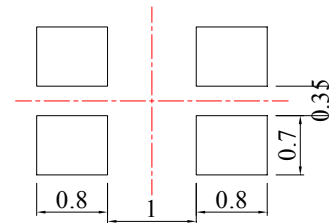

### Notes:

1. All dimensions are in millimeters (inches).
2. Tolerance is  $\pm 0.25$  mm (.010") unless otherwise noted.

## S175EVPGC-2B-G51BJ

2.0x1.25mm, Red & Pure Green LED

Surface Mount Bi-Color Chip LED Indicator

LuckyLight

### Technical Data Sheet

---

#### Absolute Maximum Ratings at Ta=25°C

Parameters	Symbol	Emitting Color	Max.	Unit
Power Dissipation	PD	Red	60	mW
		Pure Green	90	
Peak Forward Current <sup>(a)</sup>	IFP	Red	100	mA
		Pure Green	100	
Continuous Forward Current <sup>(b)</sup>	IF	Red	25	mA
		Pure Green	25	
Reverse Voltage	VR	5		V
Electrostatic Discharge (HBM)	ESD	Red	2000	V
		Pure Green	1000	V
Operating Temperature Range	Topr	-40°C to +80°C		
Storage Temperature Range	Tstg	-40°C to +85°C		
Soldering Temperature	Tsld	260°C for 5 Seconds		

Notes:

a. Derate linearly as shown in derating curve.

b. Duty Factor = 10%, Frequency = 1 kHz

# S175EVPGC-2B-G51BJ

2.0x1.25mm, Red & Pure Green LED

Surface Mount Bi-Color Chip LED Indicator

## Technical Data Sheet

### Electrical Optical Characteristics at Ta=25°C

Parameters	Symbol	Emitting Color	Min.	Typ.	Max.	Unit	Test Condition
Luminous Intensity <sup>(a)</sup>	IV	Red	80	120	---	mcd	IF=20mA
		Pure Green	400	550	---		
Viewing Angle <sup>(b)</sup>	2θ1/2	Red	---	120	---	Deg	IF=20mA
		Pure Green	---	120	---		
Peak Emission Wavelength	λp	Red	---	632	---	nm	IF=20mA
		Pure Green	---	525	---		
Dominant Wavelength <sup>(c)</sup>	λd	Red	---	624	---	nm	IF=20mA
		Pure Green	---	520	---		
Spectral Line Half-Width	Δλ	Red	---	20	---	nm	IF=20mA
		Pure Green	---	25	---		
Forward Voltage	VF	Red	1.60	2.00	2.40	V	IF=20mA
		Pure Green	2.80	3.20	3.60		
Reverse Current	IR	Red	---	---	10	μA	VR=5V
		Pure Green	---	---	10		

#### Notes:

- Luminous intensity is measured with a light sensor and filter combination that approximates the CIE eye-response curve.
- 2θ1/2 is the o -axis angle where the luminous intensity is 1/2 the peak intensity
- The dominant wavelength (λd) is derived from the CIE chromaticity diagram and represents the single wavelength which defines the color of the device.

# S175EVPGC-2B-G51BJ

2.0x1.25mm, Red & Pure Green LED

Surface Mount Bi-Color Chip LED Indicator



## Technical Data Sheet

### Typical Electrical / Optical Characteristics Curves

(25°C Ambient Temperature Unless Otherwise Noted)

Red:

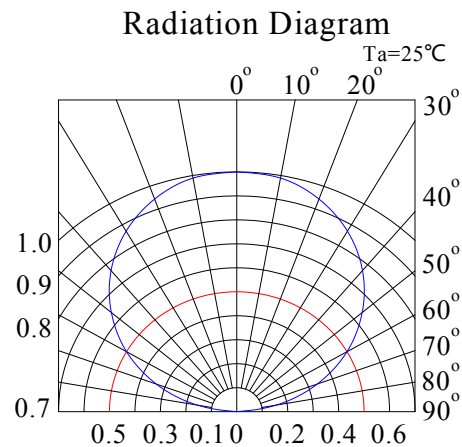
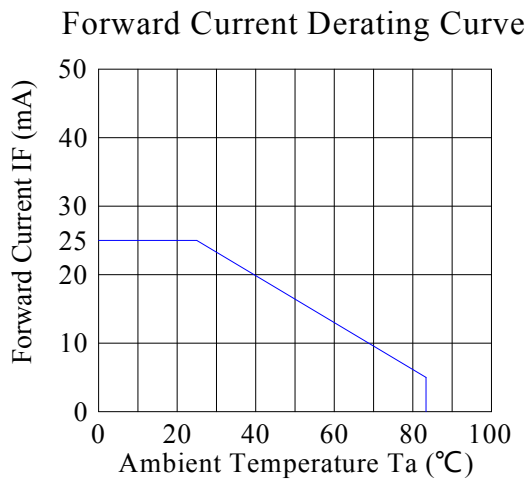
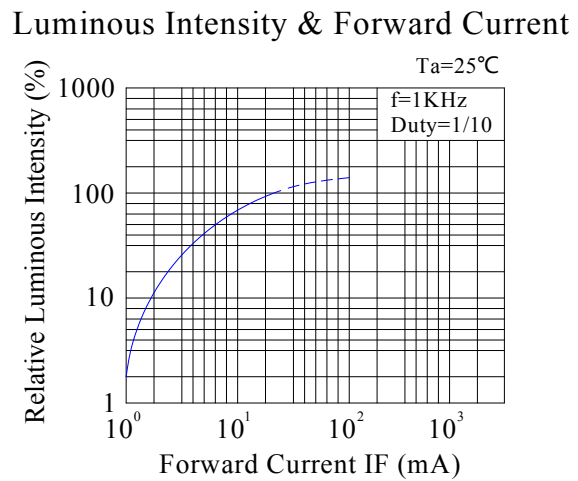
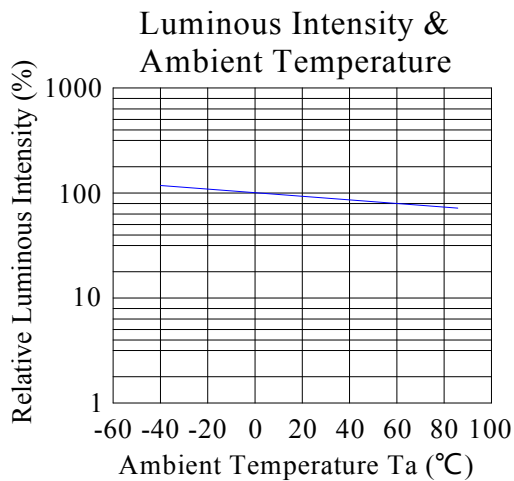
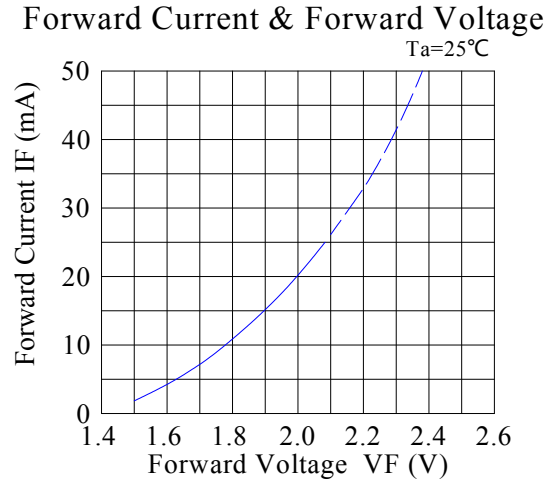
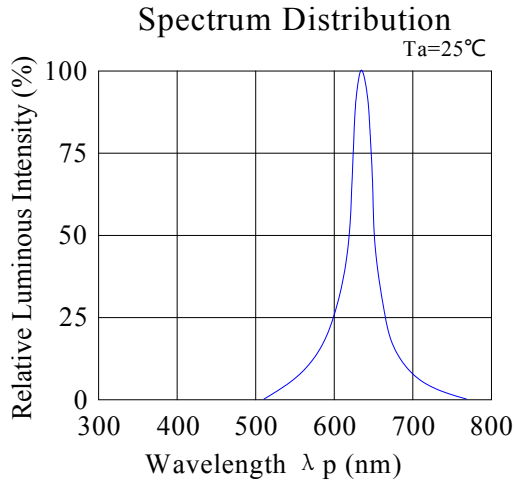

**S175EVPGC-2B-G51BJ**  
**2.0x1.25mm, Red & Pure Green LED**  
**Surface Mount Bi-Color Chip LED Indicator**

**Technical Data Sheet**

Pure Green:

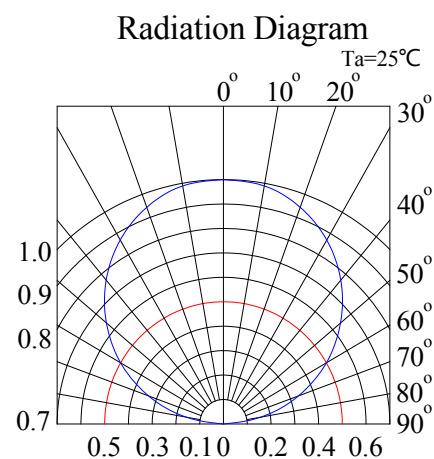
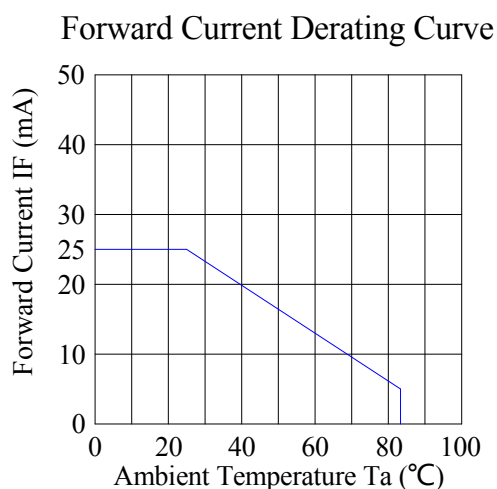
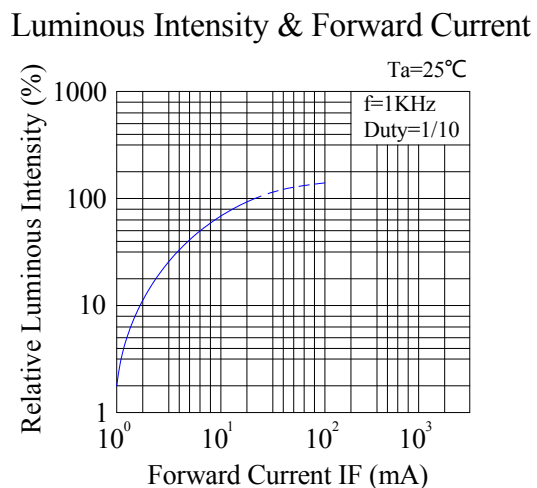
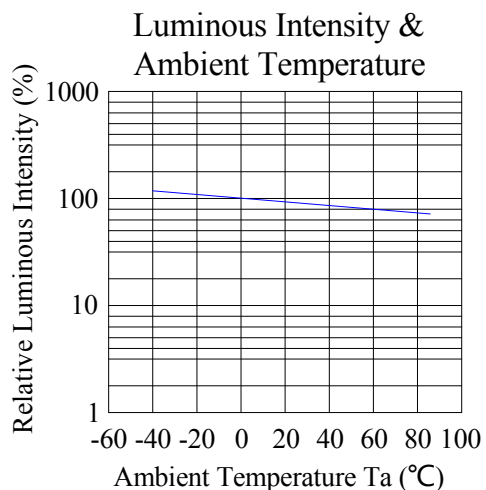
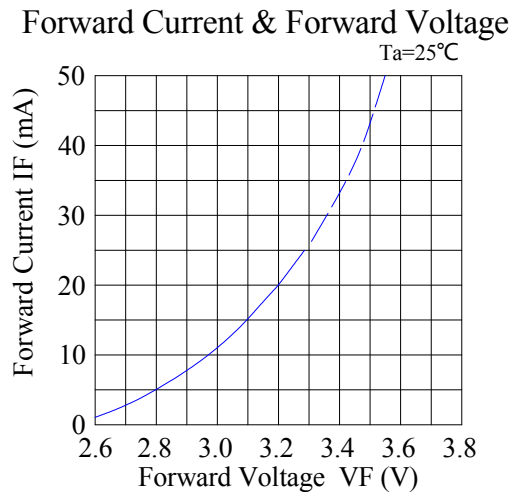
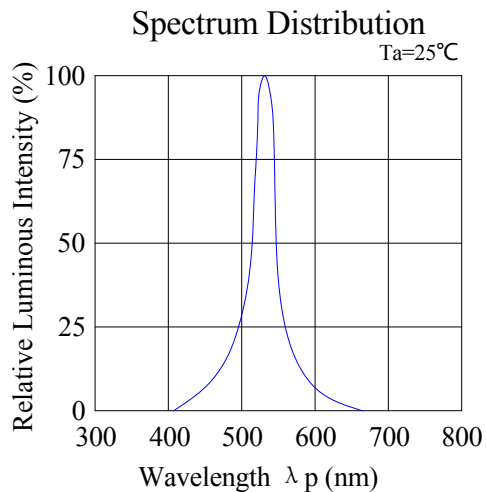



# S175EVPGC-2B-G51BJ

2.0x1.25mm, Red & Pure Green LED

Surface Mount Bi-Color Chip LED Indicator



## Technical Data Sheet

### Packing & Label Specifications:

Moisture Resistant Packaging:

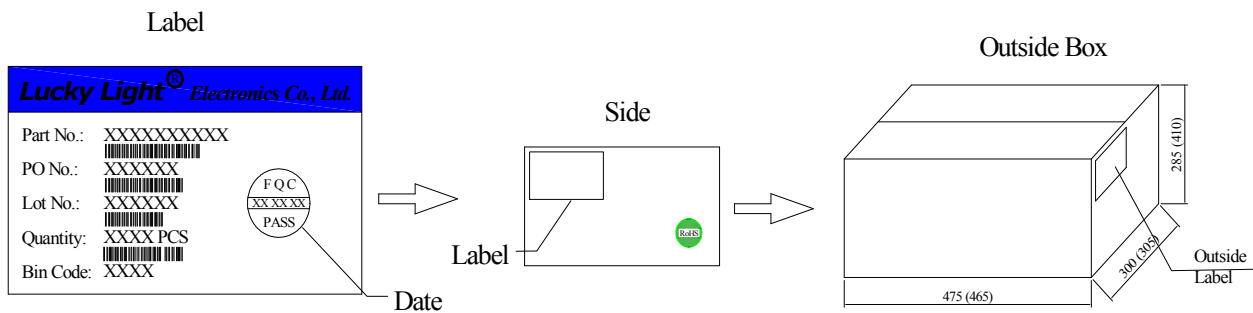
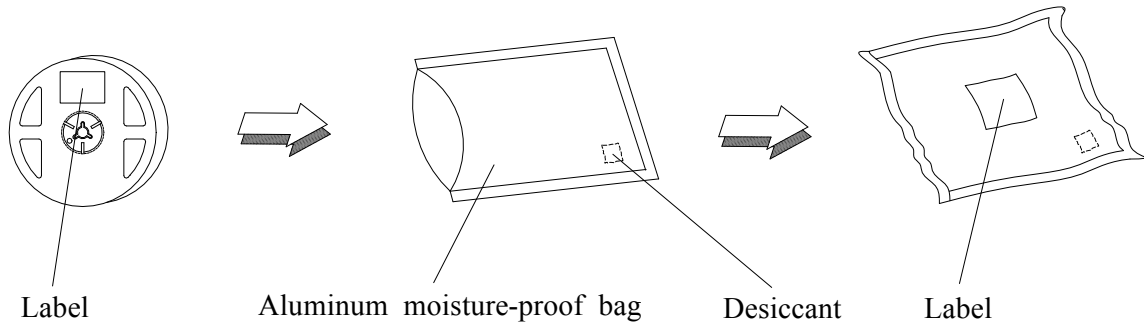



# S175EVPGC-2B-G51BJ

2.0x1.25mm, Red & Pure Green LED

Surface Mount Bi-Color Chip LED Indicator

LuckyLight

## Technical Data Sheet

### CAUTIONS

#### 1. Handling Precautions:

- 1.1. Handle the component along the side surfaces by using forceps or appropriate tools.
- 1.2. Do not directly touch or handle the silicone lens surface. It may damage the internal circuitry.
- 1.3. Do not stack together assembled PCBs containing exposed LEDs. Impact may scratch the silicone lens or damage the internal circuitry.

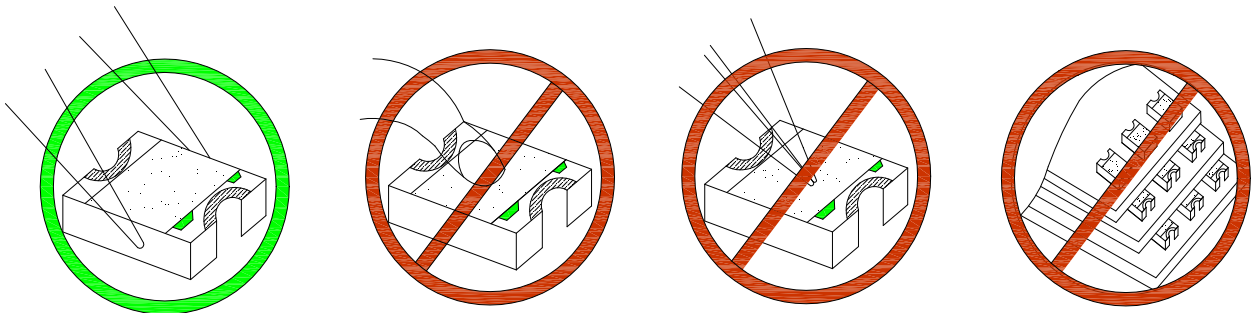

Compare to epoxy encapsulant that is hard and brittle, silicone is softer and flexible. Although its characteristic significantly reduces thermal stress, it is more susceptible to damage by external mechanical force. As a result, special handling precautions need to be observed during assembly using silicone encapsulated LED products. Failure to comply might lead to damage and premature failure of the LED.

#### 2. Storage

- 1.4. Do not open moisture proof bag before the products are ready to use.
- 1.5. Before opening the package, the LEDs should be kept at 30°C or less and 60%RH or less.
- 1.6. The LEDs should be used within a year.
- 1.7. After opening the package, the LEDs should be kept at 30°C or less and 60%RH or less.
- 1.8. The LEDs should be used within 168 hours after opening the package.
- 1.9. If the moisture adsorbent material has fabled away or the LEDs have exceeded the storage time, baking treatment should be performed using the following conditions. Baking treatment: 65±5°C for 24 hours.

**Technical Data Sheet**

**3. Soldering Condition**

1.10. Pb-free solder temperature profile

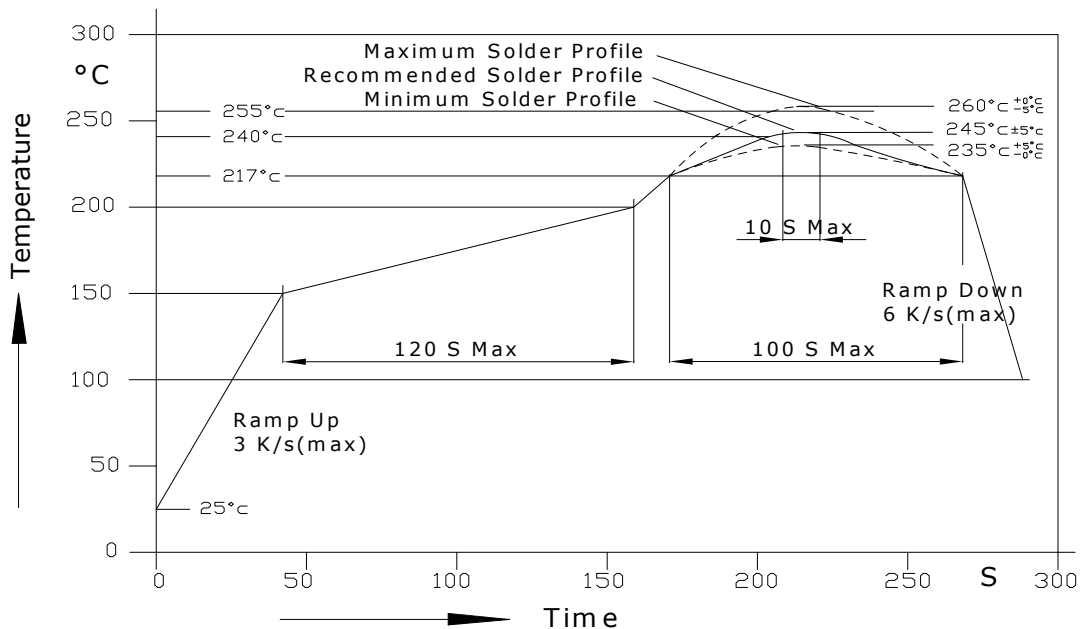

- 1.11. Reflow soldering should not be done more than two times.
- 1.12. When soldering, do not put stress on the LEDs during heating.
- 1.13. After soldering, do not warp the circuit board.
- 1.14. Recommended soldering conditions:

Reflow soldering		Soldering iron	
Pre-heat	150~200°C	Temperature	300°C Max.
Pre-heat time	120 sec. Max.	Soldering time	3 sec. Max.
Peak temperature	260°C Max.		(one time only)
Soldering time	10 sec. Max.(Max. two times)		

1.15. Because different board designs use different number and types of devices, solder pastes, reflow ovens, and circuit boards, no single temperature profile works for all possible combinations.

However, you can successfully mount your packages to the PCB by following the proper guidelines and PCB-specific characterization.

## Technical Data Sheet

---

### Drive Method

1.16. An LED is a current-operated device. In order to ensure intensity uniformity on multiple LEDs connected in parallel in an application, it is recommended that a current limiting resistor be incorporated in the drive circuit, in series with each LED as shown in Circuit A below.

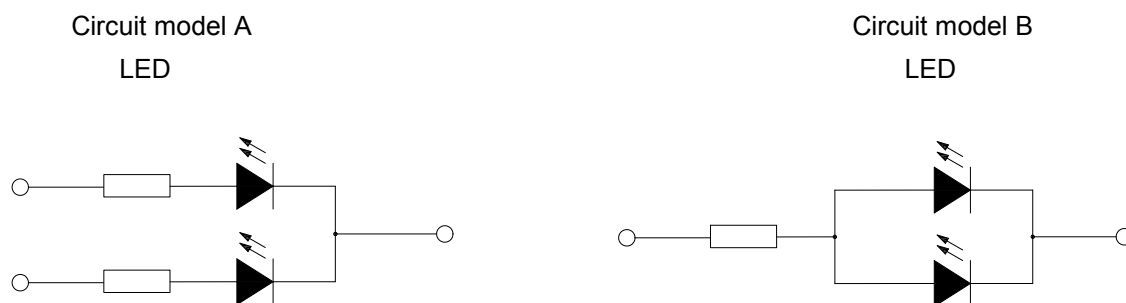

a Recommended circuit.

b The brightness of each LED might appear different due to the differences in the I-V characteristics of those LEDs.

### Terms and conditions for the usage of this document

1. The information included in this document reflects representative usage scenarios and is intended for technical reference only.
2. The part number, type, and specifications mentioned in this document are subject to future change and improvement without notice. Before production usage customer should refer to the latest datasheet for the updated specifications.
3. When using the products referenced in this document, please make sure the product is being operated within the environmental and electrical limits specified in the datasheet. If customer usage exceeds the specified limits, LuckyLight will not be responsible for any subsequent issues.
4. The information in this document applies to typical usage in consumer electronics applications. If customer's application has special reliability requirements or have life-threatening liabilities, such as automotive or medical usage, please consult with LuckyLight representative for further assistance.
5. The contents and information of this document may not be reproduced or re-transmitted without permission by LuckyLight.

## X-ON Electronics

Largest Supplier of Electrical and Electronic Components

*Click to view similar products for [Standard LEDs - SMD category](#):*

*Click to view products by [Lucky Light manufacturer](#):*

Other Similar products are found below :

[LTST-C190KYKT](#) [LTST-C19GD2WT](#) [LTST-N683GBEW](#) [LTW-170ZDC](#) [LTW-M140SZS40](#) [598-8110-100F](#) [598-8610-202F](#)  
[AAAF5060QBFSEEZGS](#) [APT1608QGW](#) [EAST2012YA0](#) [SML-512VWT86A](#) [SML-LX0606SISUGC/A](#) [SML-LXR851SIUPGUBC](#)  
[LT1ED53A](#) [AM27ZGC03](#) [APFA3010SURKCGKQBDC](#) [APHK1608VGCA](#) [APT2012QGW](#) [CLX6D-FKB-CN1R1H1BB7D3D3](#) [LTST-](#)  
[008BGEW](#) [LTW-010DCG](#) [LTW-020ZDCG](#) [LTW-21TS5](#) [LTW-220DS5](#) [598-8330-117F](#) [SML-LX0402IC-TR](#) [CMDA20AYAA7D1S](#)  
[CMDA16AYDR7A1X](#) [598-8040-100F](#) [598-8070-100F](#) [598-8140-100F](#) [598-8610-200F](#) [EAST2012GA0](#) [EAPL3527GA5](#) [EAST2012RA0](#)  
[CMD91-21VRC/TR7](#) [SML-512PWT86A](#) [SMF-2432GYC-TR](#) [EASV3015RGYA0](#) [LTST-C190KFKT-5A](#) [LTST-C194TBKT-5A](#) [CLX6E-](#)  
[FKC-CH1M1D1BB7C3D3](#) [SML-LXL0805USBC-TR](#) [SML-LX2835SYSUGCTR](#) [LTW-M670ZVS-M5](#) [APA2106ZGC/G](#) [CLMXB-FKA-](#)  
[CbcfghjnpACBB79463](#) [VFA1101W-5AY3B2-TR](#) [LCB P473-P2R2-3J7L-1-Z](#) [HSMR-C197](#)