

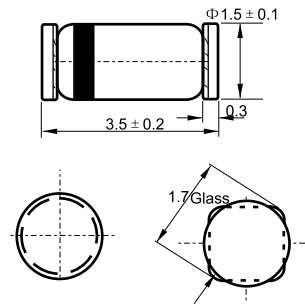

Features

- ✧ Zener voltage range 2.0 to 75 volts
- ✧ LL-34(Mini-MELF) package
- ✧ Surface device type mounting
- ✧ Hermetically sealed glass
- ✧ Compression Bonded Construction
- ✧ All external surfaces are corrosion resistant and terminals are readily solderable
- ✧ RoHS compliant
- ✧ Matte Tin(Sn) lead finish
- ✧ Blue color band indicates negative polarity

MINI-MELF



Dimension in millimeters

Maximum Ratings and Electrical Characteristics

Rating at 25 °C ambient temperature unless otherwise specified.

Type Number	Symbol	Value	Units
Power Dissipation	P _{tot}	500	mW
Operating and Storage Temperature Range	T _J , T _{STG}	-65 to + 200	°C

Notes: These ratings are limiting values above which the serviceability of the diode may be impaired

RATINGS AND CHARACTERISTIC CURVES (BZV55C SERIES)

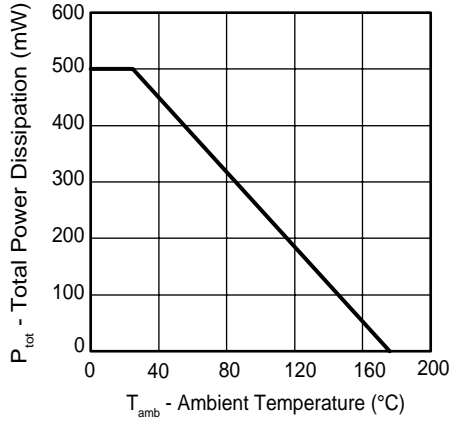

Figure 1. Total Power Dissipation vs. Ambient Temperature

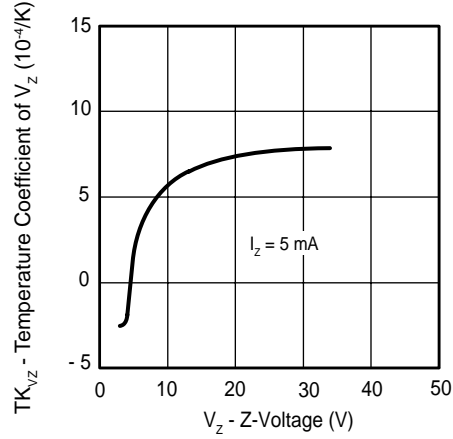

Figure 4. Temperature Coefficient of Vz vs. Z-Voltage

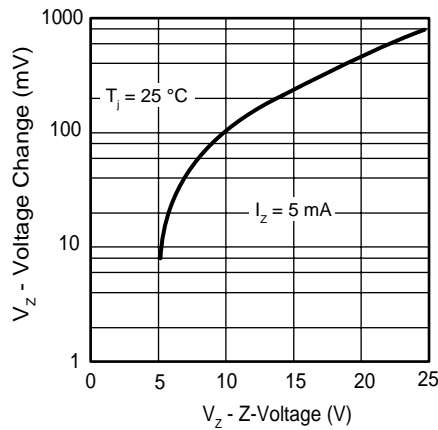

Figure 2. Typical Change of Working Voltage under Operating Conditions at $T_{amb}=25^{\circ}\text{C}$

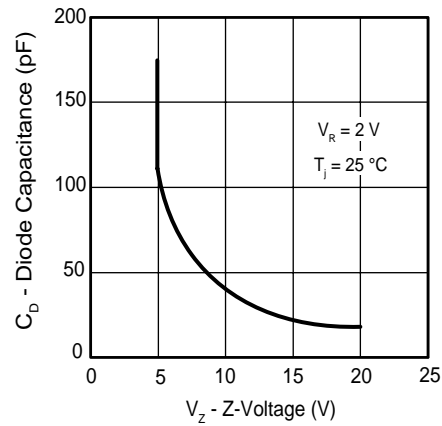

Figure 5. Diode Capacitance vs. Z-Voltage

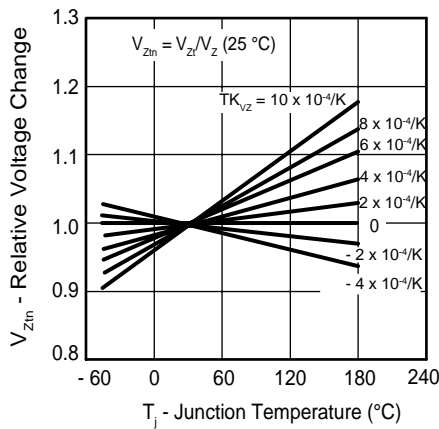

Figure 3. Typical Change of Working Voltage vs. Junction Temperature

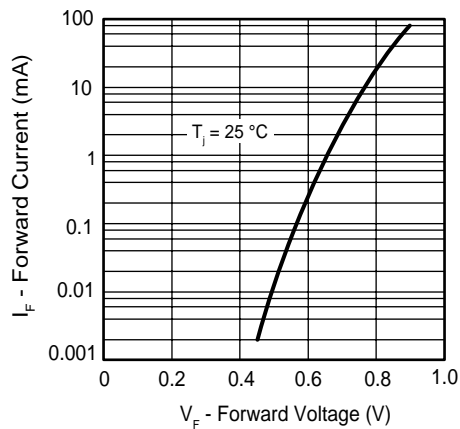

Figure 6. Forward Current vs. Forward Voltage

RATINGS AND CHARACTERISTIC CURVES (BZV55C SERIES)

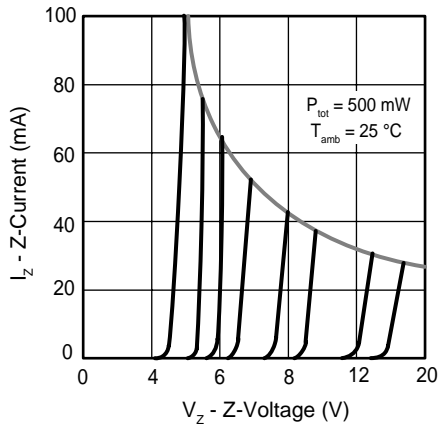

Figure 7. Z-Current vs. Z-Voltage

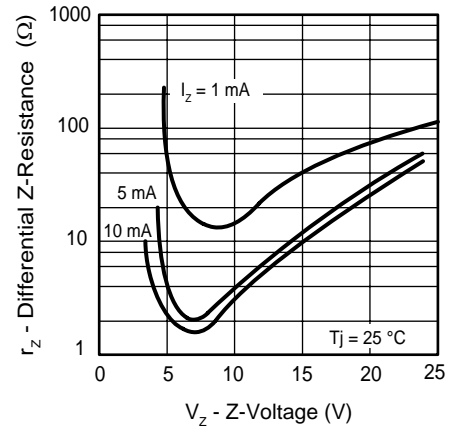

Figure 9. Differential Z-Resistance vs. Z-Voltage

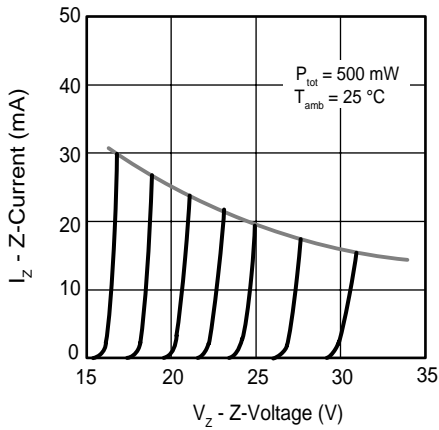

Figure 8. Z-Current vs. Z-Voltage

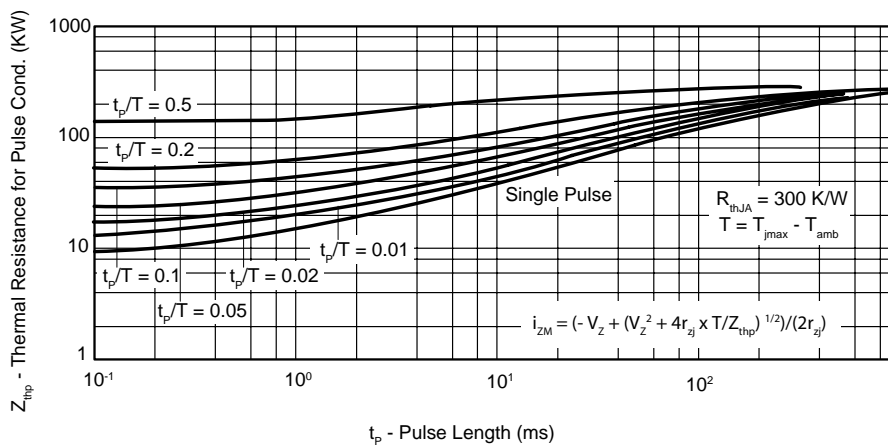

Figure 10. Thermal Response

ELECTRICAL CHARACTERISTICS (TA=25°C unless otherwise noted)

Type Number	V _Z @ I _{ZT} (Volts)		I _{ZT} mA	Z _{ZT} @ I _{ZT} Ohms Max	I _{ZK} mA	Z _{ZK} @ I _{ZK} Ohms	I _R @ V _R uA Max	V _R V
	V _Z Min (V)	V _Z Max (V)						
BZV55C2V0	1.88	2.11	5	100	1.0	600	50	1.0
BZV55C2V2	2.08	2.33	5	100	1.0	600	50	1.0
BZV55C2V4	2.28	2.56	5	85	1.0	600	50	1.0
BZV55C2V7	2.51	2.89	5	85	1.0	600	10	1.0
BZV55C3V0	2.8	3.2	5	85	1.0	600	4	1.0
BZV55C3V3	3.1	3.5	5	85	1.0	600	2	1.0
BZV55C3V6	3.4	3.8	5	85	1.0	600	2	1.0
BZV55C3V9	3.7	4.1	5	85	1.0	600	2	1.0
BZV55C4V3	4.0	4.6	5	75	1.0	600	1	1.0
BZV55C4V7	4.4	5.0	5	60	1.0	600	0.5	1.0
BZV55C5V1	4.8	5.4	5	35	1.0	550	0.1	1.0
BZV55C5V6	5.2	6.0	5	25	1.0	450	0.1	1.0
BZV55C6V2	5.8	6.6	5	10	1.0	200	0.1	2.0
BZV55C6V8	6.4	7.2	5	8	1.0	150	0.1	3.0
BZV55C7V5	7.0	7.9	5	7	1.0	50	0.1	5.0
BZV55C8V2	7.7	8.7	5	7	1.0	50	0.1	6.2
BZV55C9V1	8.5	9.6	5	10	1.0	50	0.1	6.8
BZV55C10	9.4	10.6	5	15	1.0	70	0.1	7.5
BZV55C11	10.4	11.6	5	20	1.0	70	0.1	8.2
BZV55C12	11.4	12.7	5	20	1.0	90	0.1	9.1
BZV55C13	12.4	14.1	5	26	1.0	110	0.1	10
BZV55C15	13.8	15.6	5	30	1.0	110	0.1	11
BZV55C16	15.3	17.1	5	40	1.0	170	0.1	12
BZV55C18	16.8	19.1	5	50	1.0	170	0.1	13
BZV55C20	18.8	21.1	5	55	1.0	220	0.1	15
BZV55C22	20.8	23.3	5	55	1.0	220	0.1	16
BZV55C24	22.8	25.6	5	80	1.0	220	0.1	18
BZV55C27	25.1	28.9	2	80	1.0	220	0.1	20
BZV55C30	28	32	2	80	1.0	220	0.1	22
BZV55C33	31	35	2	80	1.0	220	0.1	24
BZV55C36	34	38	2	80	1.0	220	0.1	27
BZV55C39	37	41	2	90	0.5	500	0.1	28
BZV55C43	40	46	2	90	0.5	600	0.1	32
BZV55C47	44	50	2	110	0.5	700	0.1	35
BZV55C51	48	54	2	125	0.5	700	0.1	38
BZV55C56	52	60	2	135	0.5	1000	0.1	42
BZV55C62	58	66	2.5	150	0.5	1000	0.1	47
BZV55C68	64	72	2.5	160	0.5	1000	0.1	51
BZV55C75	70	80	2.5	170	0.5	1000	0.1	56

VF Forward Voltage = 1.0v Maximum @ IF=100mA for all types.

- Notes:
1. The type numbers listed have zener voltage min/max limits as shown.
 2. The zener impedance is derived from the 60-cycle ac voltage, which results when an ac current having an rms value equal to 10% of the dc zener current (I_{ZT} or I_{ZK}) is superimposed to I_{ZT} or I_{ZK}.

X-ON Electronics

Largest Supplier of Electrical and Electronic Components

Click to view similar products for [Zener Diodes](#) category:

Click to view products by [Luguang](#) manufacturer:

Other Similar products are found below :

[RKZ13B2KG#P1](#) [DL5234B](#) [1N4682](#) [1N4691](#) [1N4693](#) [1N4732A](#) [1N4733A-TR](#) [1N4736A](#) [1N4750A](#) [1N4759ARL](#) [1N5241B](#) [1N5365B](#)
[1N5369B](#) [1N747A](#) [1N959B](#) [1N964B](#) [1N966B](#) [1N968B](#) [1N972B](#) [NTE149A](#) [NTE5116A](#) [NTE5121A](#) [NTE5147A](#) [NTE5152A](#) [NTE5155A](#)
[NTE5164A](#) [JANS1N4974US](#) [1N4692](#) [1N4700](#) [1N4702](#) [1N4704](#) [1N4711](#) [1N4714](#) [1N4737A](#) [1N4745ARL](#) [1N4752A](#) [1N4752ARL](#)
[1N4760ARL](#) [1N5221B](#) [1N5236B](#) [1N5241BTR](#) [1N5242BTR](#) [1N5350B](#) [1N5352B](#) [1N961BRR1](#) [1N964BRL](#) [RKZ5.1BKU#P6](#)
[3SMAJ5950B-TP](#) [3SMBJ5925B-TP](#) [TDZTR24](#)