

# LGE1117

1A Low Dropout Linear Regulator

## GENERAL DESCRIPTION

The LGE1117 is a series of low dropout three-terminal regulators with a dropout of 1.15V at 1A output current.

The LGE1117 series provides current limiting and thermal shutdown. Its circuit includes a trimmed bandgap reference to assure output voltage accuracy to be within 1%. Current limit is trimmed to ensure specified output Current and controlled short-circuit current. On-chip thermal shutdown provides protection against any combination of overload and ambient temperature that would create excessive junction temperature.

The LGE1117 has an adjustable version, that can provide the output voltage from 1.25V to 12V with only 2 external resistors.

The LGE1117 series is available in the industry standard SOT-223,SOT-89,TO-220,TO-252 and TO-263 power packages.

## FEATURES

- Low Dropout Voltage: 1.15V at 1A Output Current
- Trimmed Current Limit
- On-Chip Thermal Shutdown
- Three-Terminal Adjustable or Fixed 1.5V, 1.8V, 2.5V, 3.3V, 5V
- Operation junction Temperature: 0 °C to125°C

## APPLICATIONS

- PC Motherboard
- LCD Monitor
- Graphic Card
- DVD-Video player
- NIC/Switch
- Telecom Modem
- ADSL Modem
- Printer and other peripheral Equipment



Figure 1. Package Types of LGE1117

# LGE1117

1A Low Dropout Linear Regulator

## PIN CONFIGURATIONS

T Package  
(SOT-223)

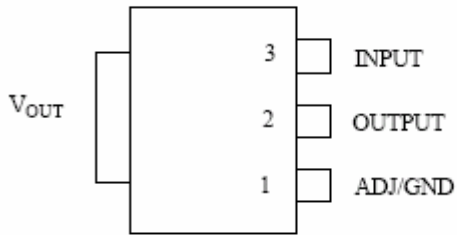

A Package  
(SOT-89)

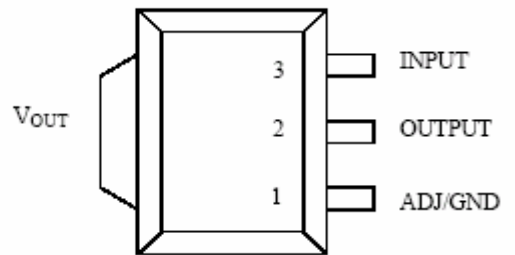

P Package  
(TO-220)

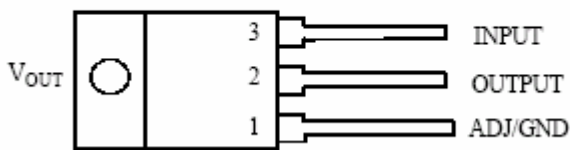

U Package  
(TO-252)

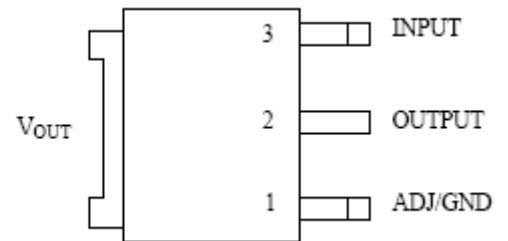

B Package  
(TO-263)

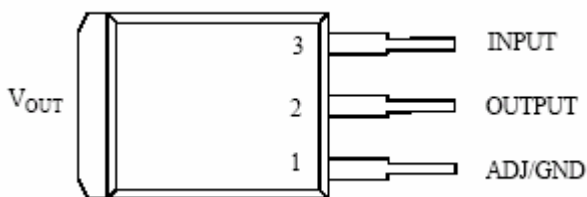

D Package  
(TO-251)

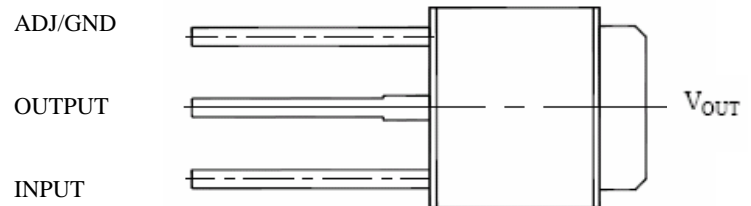

Figure 2. Pin Configurations of LGE1117

# LGE1117

1A Low Dropout Linear Regulator

## FUNCTIONAL BLOCK DIAGRAM

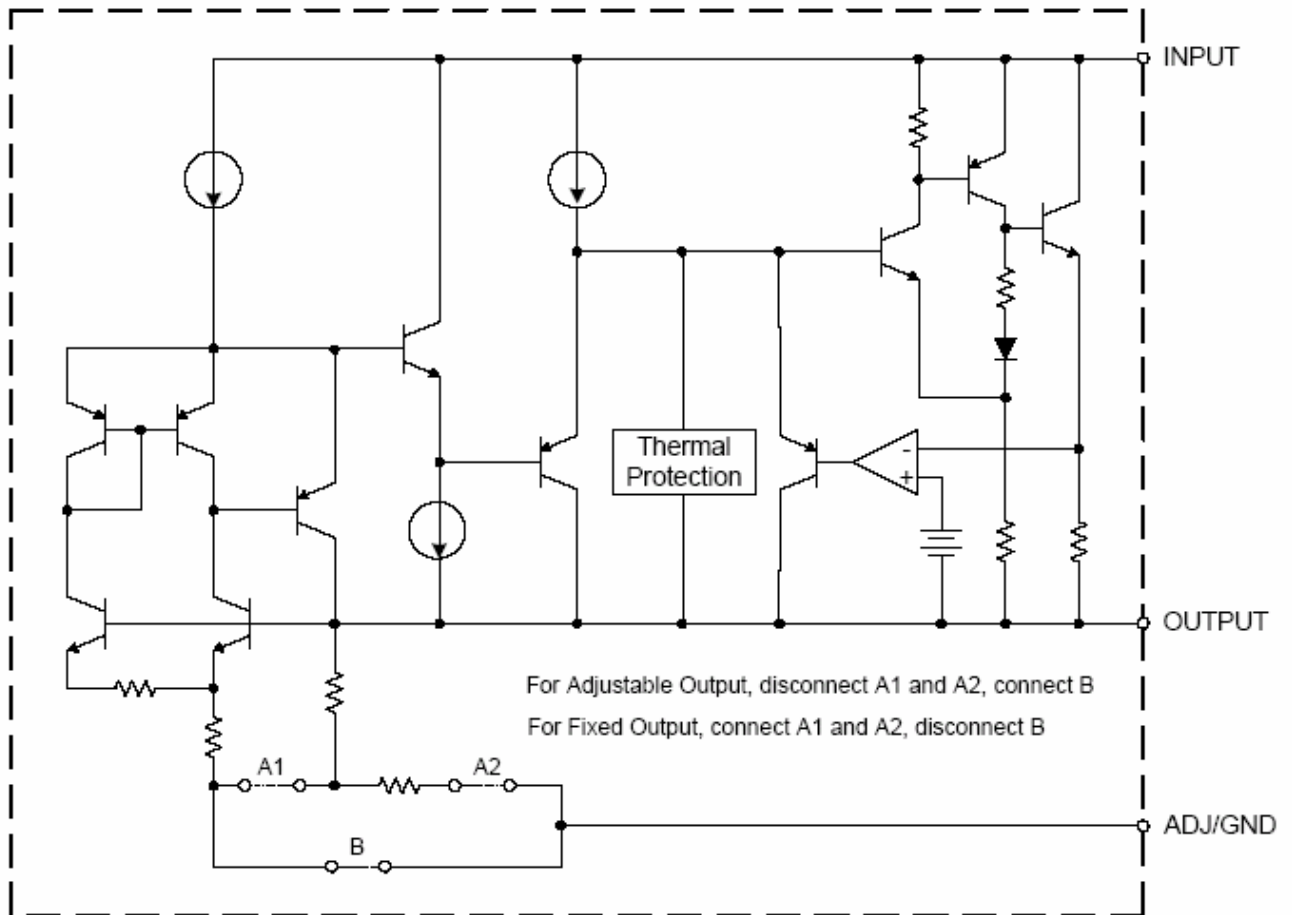

Figure 3. Functional Block Diagram of LGE1117

# LGE1117

1A Low Dropout Linear Regulator

## ORDERING INFORMATION

Package	Temperature Range	Part Number
SOT-223	0 to 125°C	LGET1117-ADJ
		LGET1117-1.5
		LGET1117-1.8
		LGET1117-2.5
		LGET1117-3.3
		LGET1117-5.0
SOT-89	0 to 125°C	LGEA1117-ADJ
		LGEA1117-1.5
		LGEA1117-1.8
		LGEA1117-2.5
		LGEA1117-3.3
		LGEA1117-5.0
TO-220	0 to 125°C	LGEP1117-ADJ
		LGEP1117-1.5
		LGEP1117-1.8
		LGEP1117-2.5
		LGEP1117-3.3
		LGEP1117-5.0
TO-252	0 to 125°C	LGEU1117-ADJ
		LGEU1117-1.5
		LGEU1117-1.8
		LGEU1117-2.5
		LGEU1117-3.3
		LGEU1117-5.0
TO-263	0 to 125°C	LGEB1117-ADJ
		LGEB1117-1.5
		LGEB1117-1.8
		LGEB1117-2.5
		LGEB1117-3.3
		LGEB1117-5.0
TO-251	0 to 125°C	LGED1117-ADJ
		LGED1117-1.5
		LGED1117-1.8
		LGED1117-2.5
		LGED1117-3.3
		LGED1117-5.0

L G E X 1117- Z



Package

T: SOT-223 U: TO-252

A: SOT-89 B: TO-263

P: TO-220 D: TO-251

Circuit Type

ADJ: Adjustable Output

1.5: Fixed Output 1.5V

1.8: Fixed Output 1.8V

2.5: Fixed Output 2.5V

3.3: Fixed Output 3.3V

5.0: Fixed Output 5.0V

# LGE1117

1A Low Dropout Linear Regulator

## ABSOLUTE MAXIMUM RATINGS (NOTE 1)

Parameter	Value	Unit
$V_{IN}$	20	V
Maximum Junction Temperature	150	°C
Storage Temperature Range	-65 to 150	°C
Lead Temperature (Soldering, 10sec.)	300	°C
ESD (Machine Model)	600	V

Note 1: Stresses greater than those listed under "Absolute Maximum Ratings" may cause permanent damage to the device. These are stress ratings only, and functional of the device at these or any other conditions beyond those indicated under "Recommended Operating Conditions" is not implied. Exposure to "Absolute Maximum Ratings" for extended periods may affect device reliability.

## RECOMMENDED OPERATING CONDITIONS

Parameter	Min	Max	Unit
$V_{IN}$		15	V
Operating Junction Temperature Range	0	125	°C

# LGE1117

1A Low Dropout Linear Regulator

## ELECTRICAL CHARACTERISTICS

Operating Conditions:  $V_{IN} \leq 10V$ ,  $T_J = 25^\circ C$  unless otherwise specified.

Parameter	Conditions	Min	Typ	Max	Unit
Reference Voltage	LGE1117-ADJ $I_{OUT} = 10mA$ , $V_{IN} - V_{OUT} = 2V$ , $10mA \leq I_{OUT} \leq 1A$ , $1.4V \leq V_{IN} - V_{OUT} \leq 8V$ , $P \leq$ Maximum power Dissipation	1.238 1.225	1.250 1.250	1.262 1.270	V
Output Voltage	LGE1117-1.5, $I_{OUT} = 10mA$ , $V_{IN} = 3.5V$ $10mA \leq I_{OUT} \leq 1A$ , $3.0V \leq V_{IN} \leq 10V$	1.485 1.470	1.5 1.5	1.515 1.530	V
	LGE1117-1.8, $I_{OUT} = 10mA$ , $V_{IN} = 3.8V$ $10mA \leq I_{OUT} \leq 1A$ , $3.2V \leq V_{IN} \leq 10V$	1.782 1.746	1.8 1.8	1.818 1.854	V
	LGE1117-2.5, $I_{OUT} = 10mA$ , $V_{IN} = 4.5V$ $10mA \leq I_{OUT} \leq 1A$ , $3.9V \leq V_{IN} \leq 10V$	2.475 2.450	2.5 2.5	2.525 2.550	V
	LGE1117-3.3, $I_{OUT} = 10mA$ , $V_{IN} = 5.0V$ $10mA \leq I_{OUT} \leq 1A$ , $4.75V \leq V_{IN} \leq 10V$	3.267 3.235	3.3 3.3	3.333 3.365	V
	LGE1117-5.0, $I_{OUT} = 10mA$ , $V_{IN} = 7.0V$ $10mA \leq I_{OUT} \leq 1A$ , $6.5V \leq V_{IN} \leq 12V$	4.950 4.900	5.0 5.0	5.050 5.100	V
Line Regulation	LGE1117-ADJ $I_{OUT} = 10mA$ , $1.5V \leq V_{IN} - V_{OUT} \leq 10V$		0.035	0.2	%
	LGE1117-1.5 $I_{OUT} = 10mA$ , $1.5V \leq V_{IN} - V_{OUT} \leq 10V$		1	6	mV
	LGE1117-1.8 $I_{OUT} = 10mA$ , $1.5V \leq V_{IN} - V_{OUT} \leq 10V$		1	6	mV
	LGE1117-2.5 $I_{OUT} = 10mA$ , $1.5V \leq V_{IN} - V_{OUT} \leq 10V$		1	6	mV
	LGE1117-3.3 $I_{OUT} = 10mA$ , $1.5V \leq V_{IN} - V_{OUT} \leq 10V$		1	6	mV
	LGE1117-5.0 $I_{OUT} = 10mA$ , $1.5V \leq V_{IN} - V_{OUT} \leq 10V$		1	10	mV
Load Regulation	LGE1117-ADJ $V_{IN} - V_{OUT} = 2V$ , $10mA \leq I_{OUT} \leq 1A$		0.2	0.4	%
	LGE1117-1.5 $V_{IN} - V_{OUT} = 2V$ , $10mA \leq I_{OUT} \leq 1A$		1	10	mV
	LGE1117-1.8 $V_{IN} - V_{OUT} = 2V$ , $10mA \leq I_{OUT} \leq 1A$		1	10	mV
	LGE1117-2.5 $V_{IN} - V_{OUT} = 2V$ , $10mA \leq I_{OUT} \leq 1A$		1	10	mV
	LGE1117-3.3 $V_{IN} - V_{OUT} = 2V$ , $10mA \leq I_{OUT} \leq 1A$		1	10	mV
	LGE1117-5.0 $V_{IN} - V_{OUT} = 2V$ , $10mA \leq I_{OUT} \leq 1A$		1	15	mV

# LGE1117

## 1A Low Dropout Linear Regulator

### ELECTRICAL CHARACTERISTICS (CONTINUED)

Operating Conditions:  $V_{IN} \leq 10V$ ,  $T_J = 25^\circ C$  unless otherwise specified.

Parameter	Conditions	Min	Typ	Max	Unit
Dropout Voltage	$\Delta V_{REF} = 1\%$ , $I_{OUT} = 0.1A$		1.00	1.1	V
	$\Delta V_{REF} = 1\%$ , $I_{OUT} = 0.5A$		1.08	1.18	V
	$\Delta V_{REF} = 1\%$ , $I_{OUT} = 1.0A$		1.15	1.25	V
Current Limit	$V_{IN} - V_{OUT} = 2V$	1.25	1.35		A
Adjust Pin Current			60	120	$\mu A$
Adjust Pin Current Change	$1.4V \leq V_{IN} - V_{OUT} \leq 10V$ , $10mA \leq I_{OUT} \leq 1A$		0.2	5	$\mu A$
Minimum Load Current (ADJ)	$1.5V \leq V_{IN} - V_{OUT} \leq 10V$ (ADJ only)		1.7	5	mA
Quiescent Current	$V_{IN} = V_{OUT} + 1.25V$		5	10	mA
Ripple Rejection	$f = 120Hz$ , $C_{OUT} = 22\mu F$ Tantalum, $V_{IN} - V_{OUT} = 3V$ , $I_{OUT} = 1A$	60	75		dB
Temperature Stability			0.5		%
Long-Term Stability	$T_A = 125^\circ C$ , 1000hrs		0.3		%
RMS Output Noise (% of $V_{OUT}$ )	$T_A = 25^\circ C$ , $10Hz \leq f \leq 10KHz$		0.003		%
Thermal Resistance, Junction to Case	SOT-89		25		$^\circ C/W$
	SOT-223		15		
	TO-252/251		10		
	TO-220		4.5		
	TO-263		4		
Thermal Shutdown	Junction Temperature		150		$^\circ C$
Thermal Shutdown Hysteresis			25		$^\circ C$

# LGE1117

1A Low Dropout Linear Regulator

## Typical Characteristics

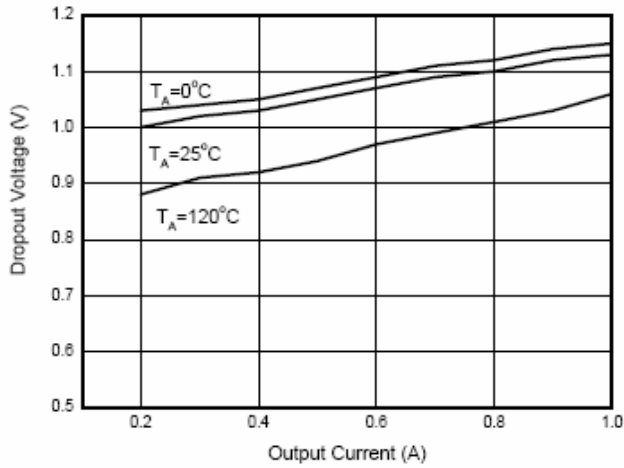

Figure 4. Dropout Voltage vs. Output Current

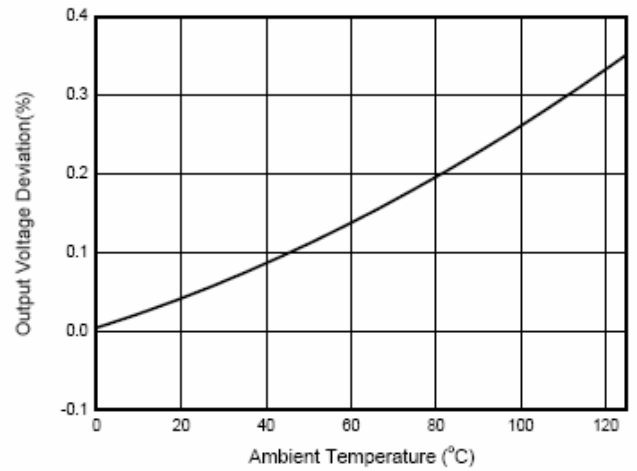

Figure 5. Load Regulation vs. Temperature

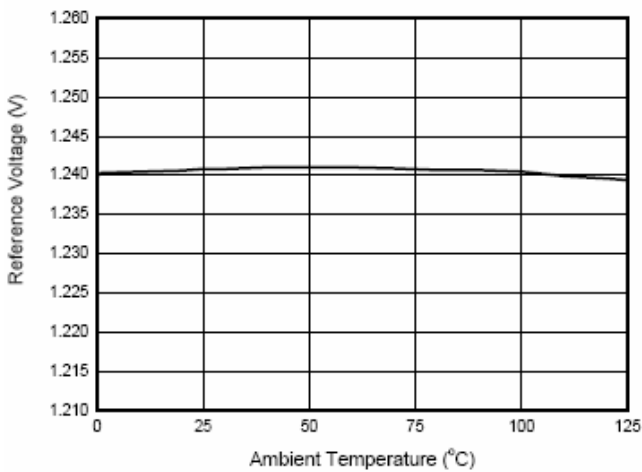

Figure 6. Reference Voltage vs. Temperature

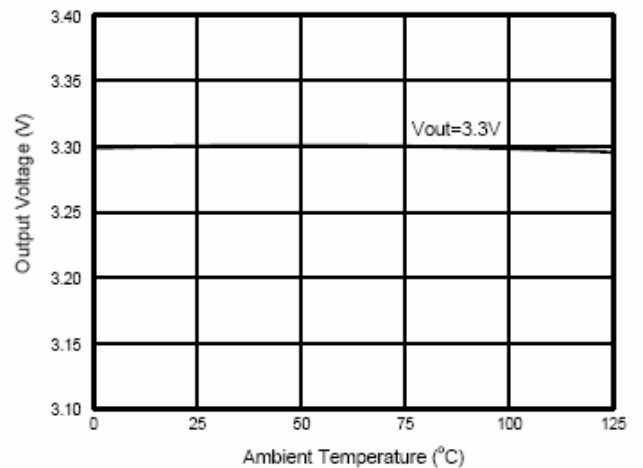

Figure 7. Output Voltage vs. Temperature



# LGE1117

1A Low Dropout Linear Regulator

## Typical Characteristics

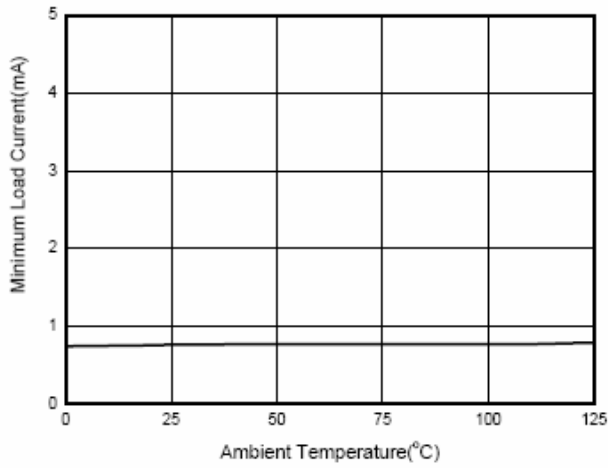

Figure 8. Minimum Load Current vs. Temperature

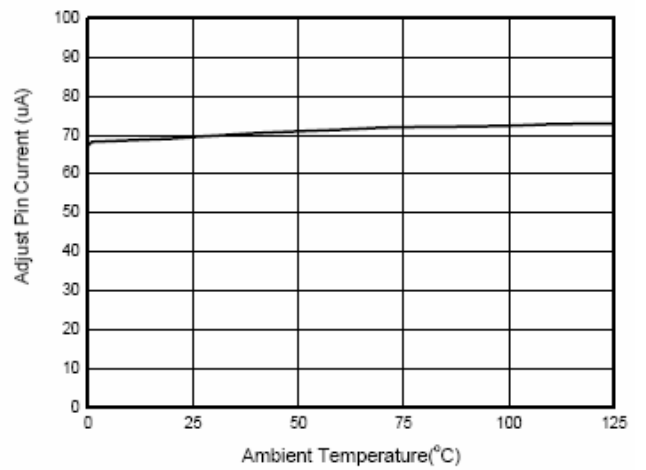

Figure 9. Adjust Pin Current vs. Temperature

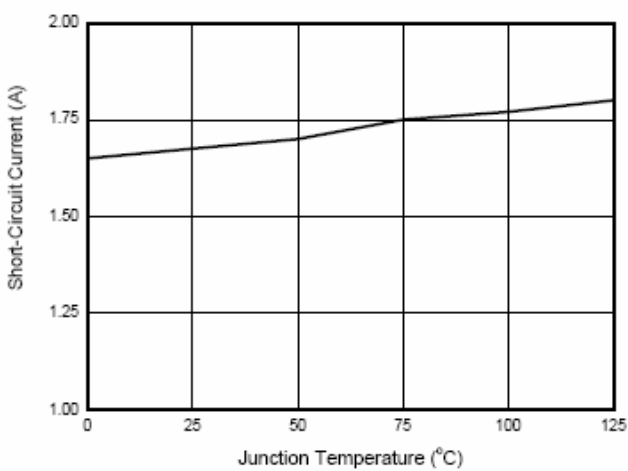

Figure 10. Short-Circuit Current vs. Temperature

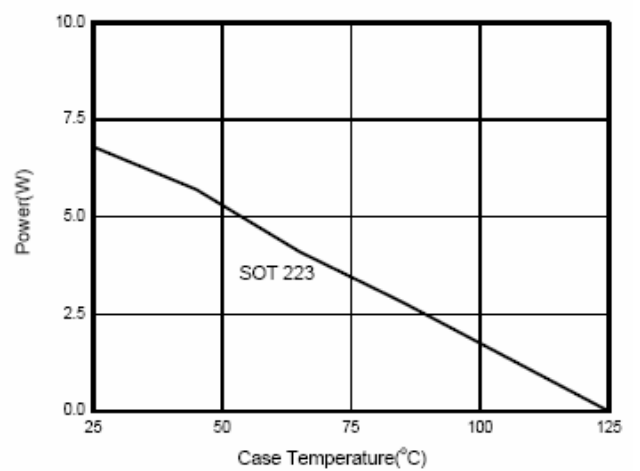

Figure 11. Maximum Power Dissipation

# LGE1117

1A Low Dropout Linear Regulator

## Typical Characteristics

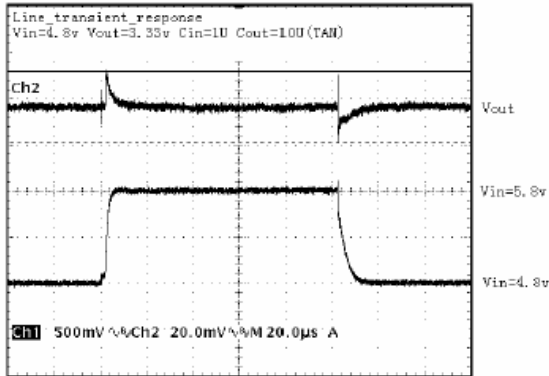

Figure 12. Line Transient Response

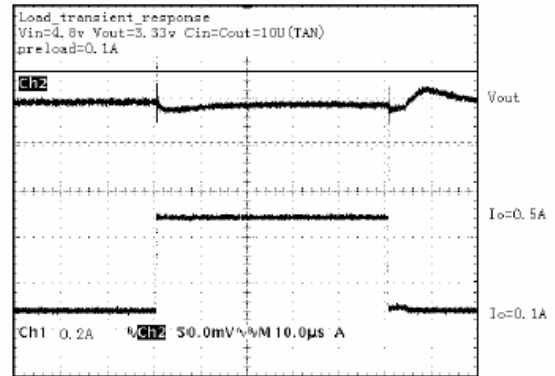

Figure 13. Load Transient Response

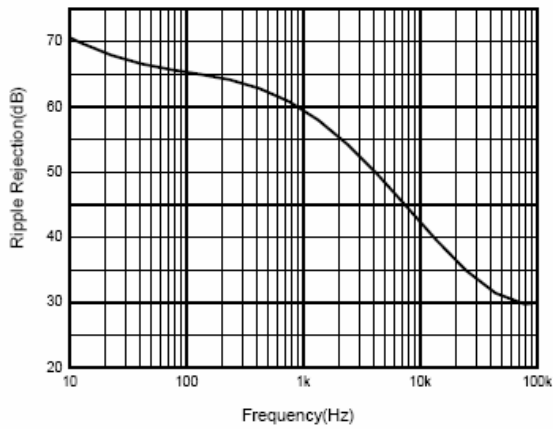

Figure 14. Ripple Rejection vs. Frequency

# LGE1117

1A Low Dropout Linear Regulator

## Typical Applications

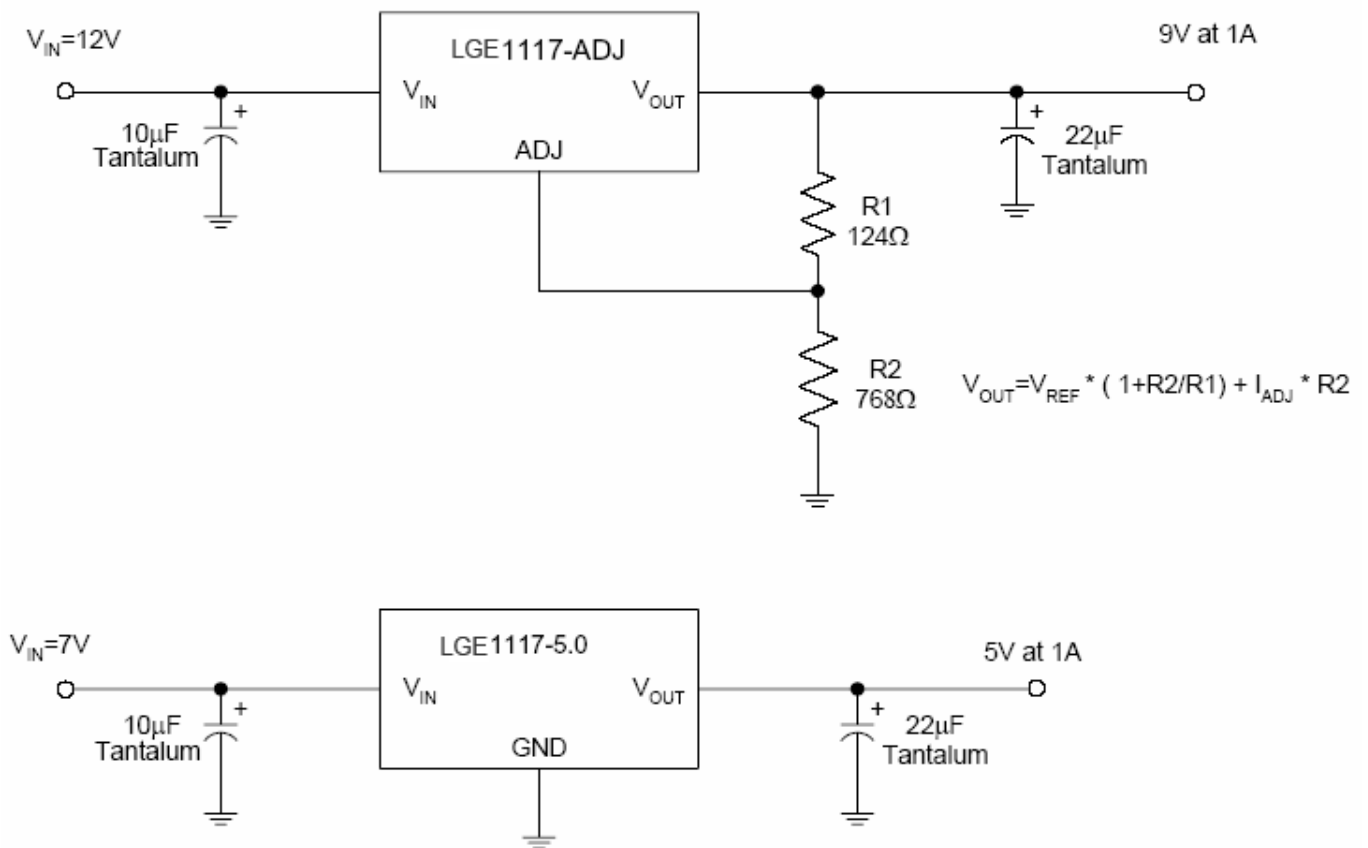

Figure 15. Typical Applications of LGE1117

## X-ON Electronics

Largest Supplier of Electrical and Electronic Components

*Click to view similar products for [LDO Voltage Regulators](#) category:*

*Click to view products by [Luguang](#) manufacturer:*

Other Similar products are found below :

[AP7363-SP-13](#) [NCV8664CST33T3G](#) [L79M05TL-E](#) [AP7362-HA-7](#) [PT7M8202B12TA5EX](#) [TCR3DF185,LM\(CT](#) [TLF4949EJ](#)  
[NCP4687DH15T1G](#) [NCV8703MX30TCG](#) [LP2951CN](#) [AP7315-25W5-7](#) [NCV47411PAAJR2G](#) [AP2111H-1.2TRG1](#) [ZLDO1117QK50TC](#)  
[AZ1117ID-ADJTRG1](#) [NCV4263-2CPD50R2G](#) [NCP706ABMX300TAG](#) [NCP114BMX075TCG](#) [MC33269T-3.5G](#) [TLE4471GXT](#) [AP7315-](#)  
[33SA-7](#) [NCV4266-2CST33T3G](#) [NCP715SQ15T2G](#) [NCV8623MN-50R2G](#) [NCV563SQ18T1G](#) [NCV8664CDT33RKG](#) [NCV4299CD250R2G](#)  
[NCP715MX30TBG](#) [NCV8702MX25TCG](#) [TLE7270-2E](#) [NCV562SQ25T1G](#) [AP2213D-3.3TRG1](#) [AP2202K-2.6TRE1](#)  
[NCV8170BMX300TCG](#) [NCV8152MX300180TCG](#) [NCP700CMT45TBG](#) [AP7315-33W5-7](#) [NCP154MX180300TAG](#) [AP2113AMTR-G1](#)  
[NJW4104U2-33A-TE1](#) [MP2013AGG-5-P](#) [NCV8775CDT50RKG](#) [NJM2878F3-45-TE1](#) [S-19214B00A-V5T2U7](#) [S-19214B50A-V5T2U7](#) [S-](#)  
[19213B50A-V5T2U7](#) [S-19214BC0A-E8T1U7\\*1](#) [S-19213B00A-V5T2U7](#) [S-19213B33A-V5T2U7](#) [S-19213BC0A-V5T2U7](#)