

M12 Actuator/Sensor Distribution Boxes

ASBS.../LED



4-, 6- and 8-Ports (LED)

Pluggable actuator/sensor distribution box with LED operation and function indicators, 4-, 6-, and 8-ports, top-entry, M12 sockets, 4-poles, 1 signals per socket, with M23 quick-disconnect for the control cable.

– control cable type: 12P: RKU 12-256/...M or RKWU 12-256/...M –

4-Ports

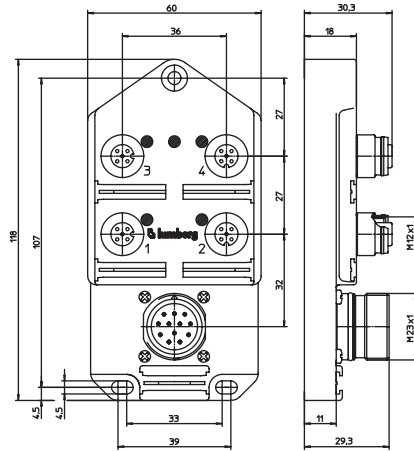

6-Ports

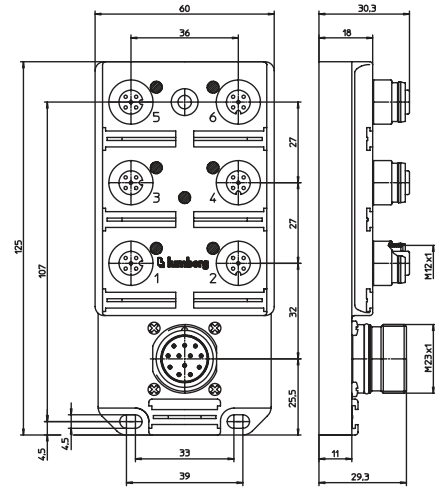

Pin Assignments

M12 / M23

Wiring Diagrams

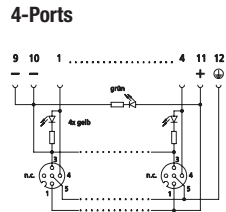
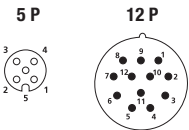

- 1 = 11 (+)
- 2 = n.c.
- 3 = 9 (-)
- 4 = 1 (1)
- 2 (2)
- 3 (3)
- 4 (4)
- 5 (5)
- 6 (6)
- 5 = 12 (PE)

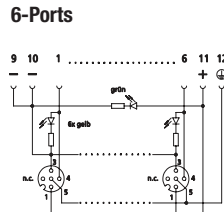

- 1 = 11 (+)
- 2 = n.c.
- 3 = 9 (-)
- 4 = 1 (1)
- 2 (2)
- 3 (3)
- 4 (4)
- 5 (5)
- 6 (6)
- 5 = 12 (PE)

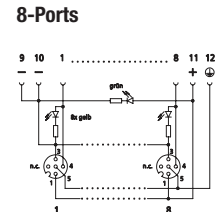

- 1 = 11 (+)
- 2 = n.c.
- 3 = 9 (-)
- 4 = 1 (1)
- 2 (2)
- 3 (3)
- 4 (4)
- 5 (5)
- 6 (6)
- 7 (7)
- 8 (8)
- 5 = 12 (PE)



M12 Actuator/Sensor Distribution Boxes
 ASBS 4 5-4/LED | ASBS 6 5-4/LED | ASBS 8 5-4/LED

8-Ports

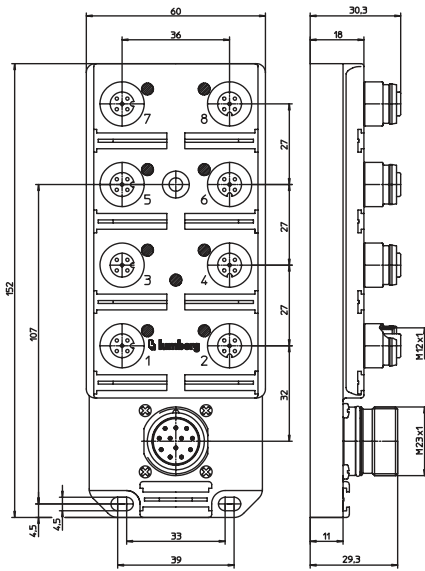

Technical Data

Environmental

Degree of protection IP 67 / NEMA 6P
 Operating temperature range -15°C (+5°F) / +80°C (+176°F)

Mechanical

Housing TPU, self-extinguishing
 Insert PA GF, self-extinguishing
 Contact CuZn, pre-nickel and 0.8 microns gold-plated
 Receptacle shell CuZn, nickel-plated
 O-ring FKM

Electrical

Contact resistance ≤5mΩ
 Voltage rating 10-30 V DC
 Current rating 4 A per port / 12 A max. total
 Insulation resistance > 10⁹ Ω

Accessories (included)

ZVK 2 dust covers for unused sockets
 ZBS 10 attachable labels

Part Number	Ports	Mating Control Cables	Characteristics
ASBS 4/LED 5-4	4	RKU 12-256/...M or RKWU 12-256/...M	
ASBS 6/LED 5-4	6	RKU 12-256/...M or RKWU 12-256/...M	
ASBS 8/LED 5-4	8	RKU 12-256/...M or RKWU 12-256/...M	

X-ON Electronics

Largest Supplier of Electrical and Electronic Components

Click to view similar products for [Sensor Cables / Actuator Cables](#) category:

Click to view products by [Lumberg](#) manufacturer:

Other Similar products are found below :

[60963](#) [60964](#) [703000D02F2002](#) [703000D02F300](#) [703001D02F1201](#) [703001D02F300](#) [704000D02F120](#) [773032K02F030](#) [802027213811-1](#)
[804001A09M150](#) [84914-0235](#) [84914-0237](#) [884031A09M005](#) [885030A09M010](#) [8R4006A18M010](#) [8R4J30E03C3003](#) [1200650503](#)
[1200651713](#) [1200680071](#) [1200720081](#) [1200720537](#) [1200870123](#) [1200650218](#) [1200661295](#) [1200661297](#) [1200661342](#) [1200670080](#)
[1200680331](#) [1200720139](#) [1200720255](#) [1200720597](#) [1200730184](#) [1200870359](#) [1200980008](#) [1200980031](#) [1210401265](#) [1211810021](#)
[1300060465](#) [1300060544](#) [1300060784](#) [1300061169](#) [1300061497](#) [1300101010](#) [1300101015](#) [1300130536](#) [1300270039](#) [1300280144](#)
[1300060347](#) [1300060350](#) [1300060550](#)