

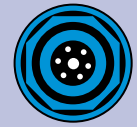

Connectors for control signals



NR-series

HiPower

Product description

Multi-pole shielded circular connectors. Design according to DIN 43651, all-metal construction, used for control and measurement systems.

- Connection of shielded cables with PG-cable gland, efficient shielding ensures transmission free of electromagnetic and parasitic interference from the PG-cable gland to the machine

- For situations susceptible to interference and safety-related applications
- Suitable for use under extreme mechanical stress

Basic data

Number of poles: 6 + PE, 11 + PE
 Operating voltage: 25 V AC; 50 V DC
 Operating current:
 10 A (6-pole), 5 A (11-pole)

Contact material/surface:

CuZn silver-plated

Protection class: IP 65







Type of connection: crimp / solder

Connection cross-section: max.

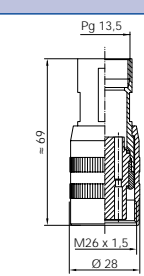
1,5 mm² (6-pole), 0,5 mm² (11-pole)

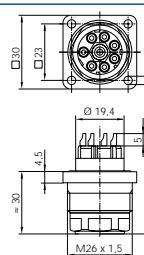

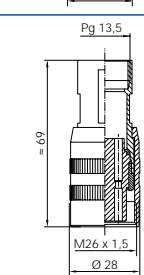

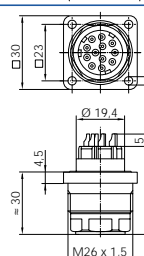

Ambient temperature: -25 ... +90°C

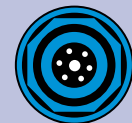
Contacts are to be ordered separately, see chapter: Contacts, crimping systems, accessories

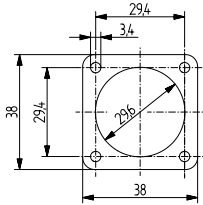
Type		Number of poles	Description	Suitable for	Order no.
 N6R EFS		6 + PE	Cable socket, straight Type of connection: crimp Contacts: RBC 162	N6R BM FA S (EMV-PG-cable gland is to be ordered separately!)	933 711-001
 N6R BM FAS		6 + PE	Surface-mounted connector with flange Type of connection: solder	N6R EF S	933 710-001
 N11R EFS		11 + PE	Cable socket, straight Type of connection: crimp Contacts: RBC 162/1	N11R BM FAS (EMV-PG-cable gland is to be ordered separately!)	933 700-001
 N11R BM FAS		11 + PE	Surface-mounted connector with flange Type of connection: solder	N11R EF S	933 699-001

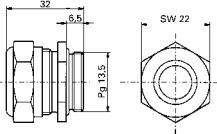
Contacts and accessories can be found in chapter: Contacts, crimping systems, accessories

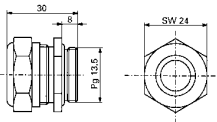

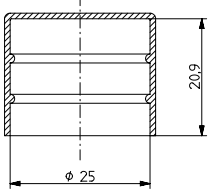
Type		Number of poles	Description	Suitable for	Order no.
 N6R-40		–	Conductive flat gasket	N6R BM FAS, N11R BM FAS	734 633-001
 N6R-41		–	EMV-PG-cable gland for lead diameter 6 - 12 mm	N6R EF S N11R EF S	734 605-001
 N6R-42		–	EMV-PG-cable gland for lead diameter 12 - 15 mm	N6R EF S, N11R EF S	734 606-001
 SHK 4		–	Protective cover for surface-mounted connector	N6R BM FAS, N11R BM FAS	734 582-001

Contacts and accessories can be found in chapter: Contacts, crimping systems, accessories



Connectors for control signals



NR-series

HiPower

Product description

Multi-pole circular connectors according to DIN 43651.

- Robust design
- Casing out of impact-proof, unbreakable plastic, glass-fibre reinforced
- Splash-proof, protection class IP 65 (DIN 40050)
- Vibration-proof connection due to central screw or screw bushing
- Strain relief due to claw cage in the

PG-cable gland

- Colour of product: grey

Basic data

Number of poles: 6 + PE, 11 + PE

Operating voltage:

250 V AC / DC (6-pole)

60 V AC / DC (11-pole)

Operating current: 10 A (6-pole),

5 A (11-pole)

Contact material/surface:

CuZn silver-plated

Protection class: IP 65

Type of connection:

crimp / screw / solder

Connection cross-section: max.

1,5 mm² (6-pole), 0,5 mm² (11-pole)







Outer cable diameter: 7-9 mm

(6-pole), 8-10 mm (11-pole)

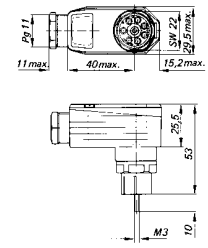
Ambient temperature: -30 ... +90°C

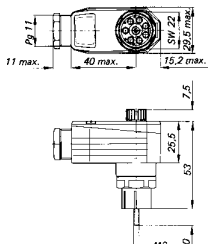
Contacts are to be ordered separately, see chapter: Contacts, crimping

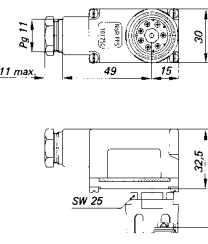
systems, accessories

Type		Number of poles	Description	Suitable for	Order no.
 N6R FF		6 + PE 	Cable socket, angled Type of connection: crimp Contacts: RBC 162	N6R AM, N6R AM..., N6R BM..., N6R DM	931 435-106
 N6R FF R		6 + PE 	Cable socket, angled with knurled screw Type of connection: crimp Contacts: RBC 162	N6R AM, N6R AM..., N6R BM..., N6R DM	931 553-106
 N6R FF S11		6 + PE 	Cable socket, angled, transparent cap, for installation of the LED insert Type of connection: screw ²	N6R AM, N6R AM..., N6R BM..., N6R DM	932 194-112

1) In accordance with the repl. docs. issued by the German PTT, No. 64.5060.678.00

2) (Socket clamp connection); LED insert type N6R 3 LED 24 or N6R 3 LED 24DB - order separately

Contacts and accessories can be found in chapter: Contacts, crimping systems, accessories









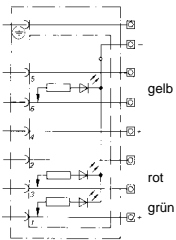

Connectors for control signals

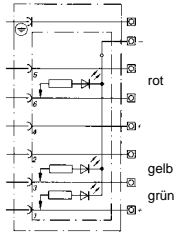

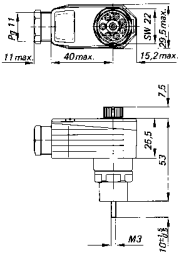
NR-series

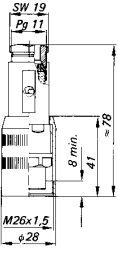
HiPower

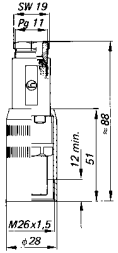

Type		Number of poles	Description	Suitable for	Order no.
		–	LED insert with 3 LEDs (green, red, yellow), Operating voltage DC 24 V Type of connection: plug in	N6R FF S 11	831 411-001
		–	LED insert with 3 LEDs (green, yellow, red), Operating voltage DC 24 V Type of connection: plug in	N6R FF S 11	831 618-001
		6 + PE 	Cable connector, angled with knurled screw, Type of connection: crimp Contacts: RSC 162	N6R AF, N6R AF 5, N6R BF...	931 727-106
		6 + PE 	Cable socket, straight Type of connection: crimp Contacts: RBC 162	N6R AM, N6R AM..., N6R BM..., N6R DM	931 720-001
		6 + PE 	Cable connector, straight Type of connection: crimp Contacts: RSC 162	N6R AF, N6R AF 5, N6R BFE	931 776-001

Contacts and accessories can be found in chapter: Contacts, crimping systems, accessories











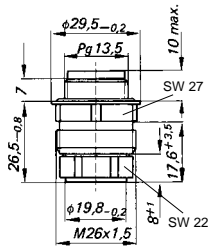

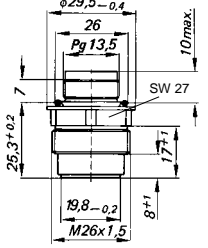
Connectors for control signals

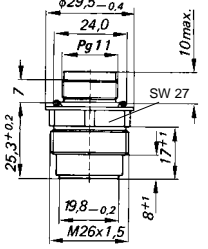

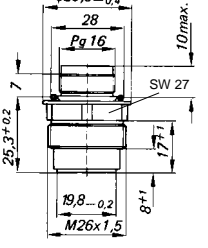
NR-series

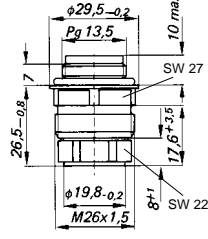
HiPower

Type		Number of poles	Description	Suitable for	Order no.
		6 + PE 	Panel-mounted connector with metal screw-in casing, PG 13,5 Type of connection: crimp Contacts: RSC 162	N6R FF, N6R FFR, N6R EF	931 434-001
		6 + PE 	Panel-mounted connector with contact bearer in the casing (monoblock design), PG 13,5 Type of connection: crimp Contacts: RSC 162	N6R FF, N6R FFR, N6R EF	931 592-001
		6 + PE 	Panel-mounted connector with contact bearer in the casing (monoblock design), PG 11 Type of connection: crimp Contacts: RSC 162	N6R FF, N6R FFR, N6R EF N6R EF	931 592-002
		6 + PE 	Panel-mounted connector with contact bearer in the casing (monoblock design), PG 16 Type of connection: crimp Contacts: RSC 162	N6R FF, N6R FFR, N6R EF	931 592-003
		6 + PE 	Panel-mounted connector with metal screw-in insert in the casing (metal segment), PG 13,5 Type of connection: crimp Contacts: RSC 162	N6R FF, N6R FFR, N6R EF	931 773-001

Contacts and accessories can be found in chapter: Contacts, crimping systems, accessories









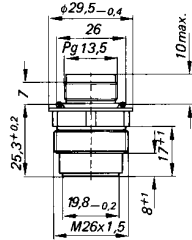

Connectors for control signals

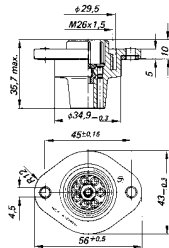

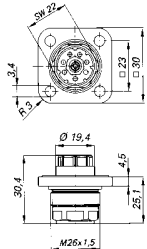
NR-series

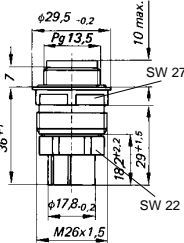
HiPower

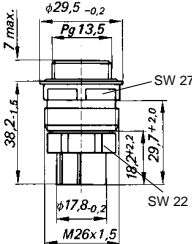

Type		Number of poles	Description	Suitable for	Order no.
		6 + PE 	Panel-mounted connector with contact bearer in the casing (monoblock design), PG 13,5 pins hermetically mounted to prevent ingress of liquids Type of connection: solder	N6R FF, N6R FFR, N6R EF	932 207-206
		6 + PE 	Panel-mounted connector with flange Type of connection: crimp Contacts: RSC 162	N6R FF, N6R FFR, N6R EF	931 731-106
		6 + PE	Surface-mounted connector with flange Type of connection: crimp Contacts: RSC 162	N6R FF, N6R FFR, N6R EF, N6R FF S 11	932 437-206
		6 + PE 	Panel-mounted socket with metal screw-in casing, PG 13,5 Type of connection: crimp Contacts: RBC 162	N6R FMR, N6R EM, N6R DM	931 855-001
		6 + PE 	Panel-mounted socket with metal screw-in insert in the casing (metal segment), PG 13,5 Type of connection: crimp Contacts: RBC 162	N6R FMR, N6R EM, N6R DM	932 164-001

Contacts and accessories can be found in chapter: Contacts, crimping systems, accessories









Connectors for control signals

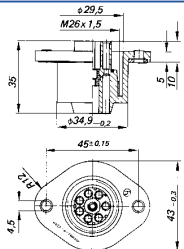

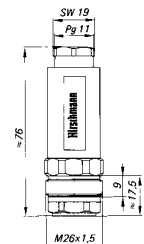
NR-series

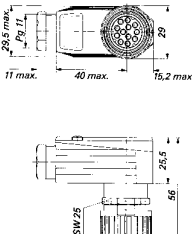
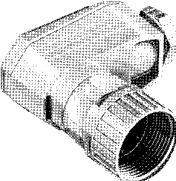
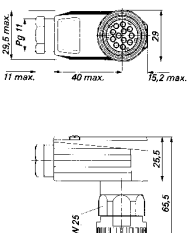
HiPower

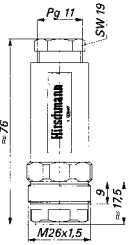
Type		Number of poles	Description	Suitable for	Order no.
 <p>N6R BFE</p>		6 + PE 	Panel-mounted socket with flange Type of connection: crimp Contacts: RBC 162	N6R FMR, N6R EM, N6R DM	931 730-106
 <p>N6R DM</p>		6 + PE	Coupling connector for cable socket N6R EF Type of connection: crimp Contacts: RSC 162	N6R EF	932 273-106
 <p>N11R FF</p>		11 + PE	Cable socket, angled Type of connection: crimp Contacts: RBC 162/1	N11R AM, N11R AM 5, N11R BM FA	932 632-106
 <p>N11R FM</p>		11 + PE	Cable connector, angled Type of connection: crimp Contacts: RSC 162/1	N11R AF, N11R AF 5	932 633-106
 <p>N11R DM</p>		11 + PE	Coupling connector for cable socket N11R EF Type of connection: crimp Contacts: RSC 162/1	N11R EF	932 629-106

Contacts and accessories can be found in chapter: Contacts, crimping systems, accessories







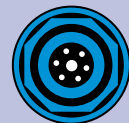

Connectors for control signals

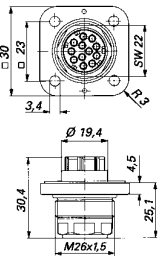

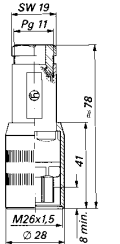
NR-series

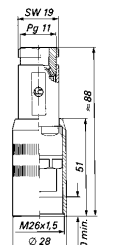
HiPower

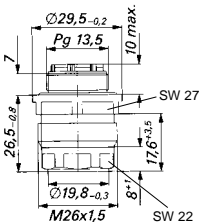

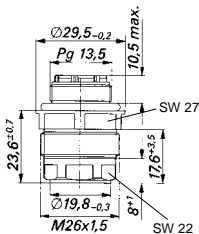
Type		Number of poles	Description	Suitable for	Order no.
 N11R BM FA		11 + PE	Surface-mounted connector with flange Type of connection: crimp Contacts: RSC 162/1	N11R FF, N11R EF	932 628-206
 N11R EF		11 + PE	Cable socket, straight Type of connection: crimp Contacts: RBC 162/1	N11R AM, N11R AM 5, N11R BM FA, N11R DM	932 630-106
 N11R EM		11 + PE	Cable connector, straight Type of connection: crimp Contacts: RSC 162/1	N11R AF, N11R AF 5	932 631-106
 N11R AM		11 + PE	Panel-mounted connector with metal screw-in casing, PG 13,5 Type of connection: crimp Contacts: RSC 162/1	N11R FF, N11R EF	932 626-106
 N11R AM 5		11 + PE	Panel-mounted connector with metal screw-in insert in the casing (metal segment), PG 13,5 Type of connection: crimp Contacts: RSC 162/1	N11R FF, N11R EF	932 627-106

Contacts and accessories can be found in chapter: Contacts, crimping systems, accessories





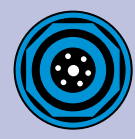

Connectors for control signals

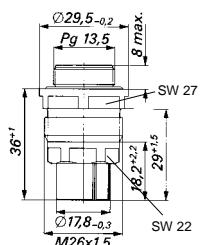

NR-series

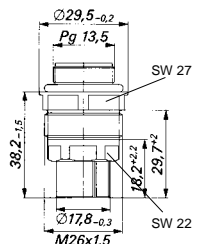
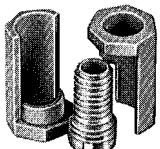
HiPower

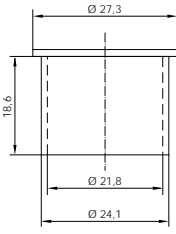

Type		Number of poles	Description	Suitable for	Order no.
 <p>N11R AF</p>		11 + PE	Panel-mounted socket with metal screw-in casing, PG 13,5 Type of connection: crimp Contacts: RBC 162/1	N11R FM, N11R EM	932 624-106
 <p>N11R AF 5</p>		11 + PE	Panel-mounted socket with metal screw-in insert in the casing (metal segment), PG 13,5 Type of connection: crimp Contacts: RBC 162/1	N11R FM, N11R EM	932 625-106
 <p>NC 6</p>		-	Coding, complete	All connectors N6R...	831 002-011
 <p>N6R-13</p>		-	Central screw with knurled head	Cable connectors and sockets N6R...	731 735-001
 <p>SHK1</p>		-	Protective cover for transport	N6R AM 2, N6R AM 3, N6R AM 4, N6R AM 2 D	733 849-011

Contacts and accessories can be found in chapter: Contacts, crimping systems, accessories

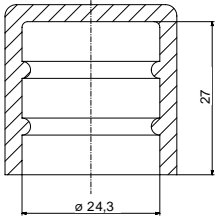

NR-series

HiPower

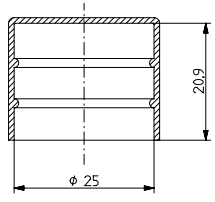
Type	Number of poles	Description	Order no.
 <p>SHK2</p> 	-	Protective cover for transport Suitable for: N6R AM, N6R AM 5, N6R BM FA, N6R AF, N6R AF 5, N6R DM, N11R DM, N11R BM FA, N11R AM, N11R AM 5, N11R AF, N11R AF 5	733 845-001
 <p>SHK4</p> 	-	Protective cover for surface-mounted connectors. Suitable for: N6R AM, N6R AM 2, N6R AM 3, N6R AM 4, N6R AM 5, N6R AM 2 D, N6R BME, N6R DM, N6R BM FA, N11R DM, N11R BM FA, N11R AM, N11R AM 5	734 582-001

Contacts and accessories can be found in chapter: Contacts, crimping systems, accessories

Notes

X-ON Electronics

Largest Supplier of Electrical and Electronic Components

Click to view similar products for [Sensor Cables / Actuator Cables](#) category:

Click to view products by [Lumberg](#) manufacturer:

Other Similar products are found below :

[60963](#) [60964](#) [M83513/19-F01CP](#) [703000D02F2002](#) [703000D02F300](#) [703001D02F0602](#) [703001D02F300](#) [704000D02F120](#) [773032K02F030](#)
[802027107404-1](#) [804001A09M150](#) [805001A09M0502](#) [84914-0235](#) [84914-0237](#) [885030A09M020](#) [1200651332](#) [1200651713](#) [1200660844](#)
[1200660845](#) [1200661173](#) [1200680071](#) [1200720053](#) [1200720081](#) [1200720099](#) [1200720217](#) [1200800231](#) [1200860125](#) [1200870123](#)
[1200980102](#) [1200650267](#) [1200650298](#) [1200660183](#) [1200660782](#) [1200660849](#) [1200661295](#) [1200661297](#) [1200661342](#) [1200661343](#)
[1200670080](#) [1200670220](#) [1200680331](#) [1200720252](#) [1200730184](#) [1200860344](#) [1200870359](#) [1200870643](#) [1200980008](#) [1200980031](#)
[1210502211](#) [1210400542](#)