

**M8-Round-Plug Connector, Single-Ended Cordsets,
According to IEC 61976-2-104**

RKMWW/LED A 3



3-Poles (LED)

Actuator/sensor cordset, single-ended, M8
3-poles, female 90 connector with LED
operation and function indicator, self-locking
threaded joint and molded cable.

RKMWW/LED

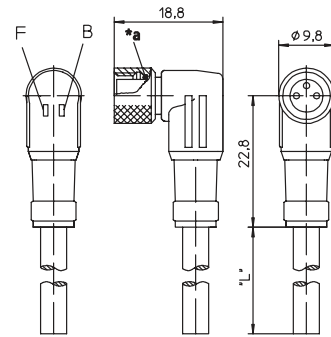

*a O-Ring

Pin Assignments

M8

3 poles

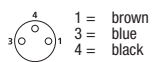

Wiring Diagram

A pnp Normally open = yellow-green

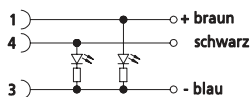



Be Certain with Belden

M8-Round-Plug Connector, Single-Ended Cordsets, According to IEC 61976-2-104
RKMWW/LED A 3

Technical Data

Environmental

Degree of protection IP 67/IP 69K / NEMA 6P
Operating temperature range -40°C (-40°F) / +90°C (+194°F)

Mechanical







Housing / Molded body TPU
Insert PA / TPU
Contact CuZn, pre-nickel and 0.8 microns gold-plated
Coupling nut CuZn, nickel-plated
O-Ring FKM

Electrical data

Contact resistance $\leq 5 \text{ m}\Omega$
Nominal current at 40°C 4 A
Nominal voltage 10-30 V DC
Insulation resistance $> 10^9 \Omega$
Pollution degree 3

Cable Specifications

Cable No.	Outer Jacket	Conductor Size	Jacket Color	OD
06	PVC	3 x 0.34 mm ²	Orange	.197" (5.0 mm)
224	PUR, halogen-free	3 x 0.34 mm ²	Black	.169" (4.3 mm)

Part Number	Pins	Outer Jacket	Standard Cable Lengths	Characteristics
RKMWW/LED A 3-06/...M	3	PVC	2 M / 5 M / 10 M	 
RKMWW/LED A 3-224/...M	4	PUR, halogen-free	2 M / 5 M / 10 M	   

X-ON Electronics

Largest Supplier of Electrical and Electronic Components

Click to view similar products for [Sensor Cables / Actuator Cables](#) category:

Click to view products by [Lumberg](#) manufacturer:

Other Similar products are found below :

[60963](#) [60964](#) [703000D02F2002](#) [703000D02F300](#) [703001D02F0602](#) [703001D02F1201](#) [703001D02F300](#) [704000D02F120](#) [773032K02F030](#)
[802027107404-1](#) [802027213811-1](#) [804001A09M150](#) [805001A09M0502](#) [84914-0235](#) [84914-0237](#) [885030A09M020](#) [1200651332](#)
[1200651713](#) [1200660844](#) [1200660845](#) [1200661173](#) [1200680071](#) [1200720053](#) [1200720081](#) [1200720099](#) [1200720217](#) [1200800231](#)
[1200860125](#) [1200870123](#) [1200980102](#) [1200650267](#) [1200650298](#) [1200660183](#) [1200660782](#) [1200660849](#) [1200661295](#) [1200661297](#)
[1200661342](#) [1200661343](#) [1200670080](#) [1200670220](#) [1200680331](#) [1200720252](#) [1200720255](#) [1200730184](#) [1200860344](#) [1200870359](#)
[1200870643](#) [1200980008](#) [1200980031](#)