

M12-Round-Plug Connector, Single-Ended Cordsets, According to IEC 61076-2-101

RKTS | RKWTH



4-, 5-, and 8-Poles (Shielded)

Actuator/sensor cordset, single-ended, M12, 4-, 5-, and 8-poles, female straight connector, internal threads with threaded joint and molded cable, shielding connecting to knurled nut.

RKTS

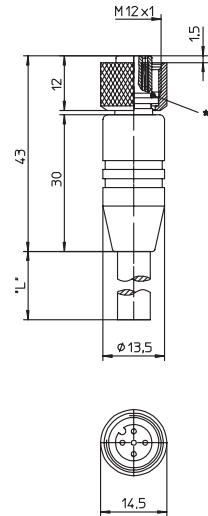

Actuator/sensor cordset, single-ended, M12, 4-, 5-, and 8-poles, female 90 °connector, internal threads with threaded joint and molded cable, shielding connecting to knurled nut.

RKWTH

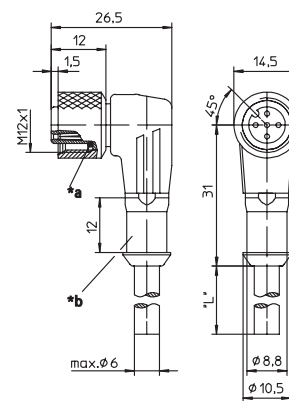

Pin Assignments

M12 - Female

4 poles

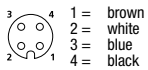

5 poles

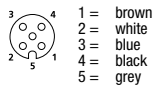

8 poles

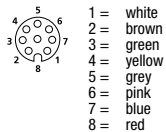



M12-Round-Plug Connector, Single-Ended Cordsets, According to IEC 61076-2-101 RKTS | RKWTH

Technical Data

Environmental

Degree of protection IP 67 / NEMA 6P
Operating temperature range -25°C (-13°F) / +80°C (+176°F)

Mechanical

Housing / Molded body TPU
Insert TPU
Contact CuSn, pre-nickel and 0.8 microns gold-plated
Coupling nut CuZn, nickel-plated
Shield sleeve CuZn, nickel-plated
O-ring FKM

Electrical









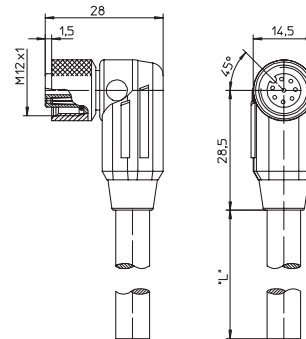





Contact resistance ≤ 5 mΩ
Nominal current at 40°C 4 A
Nominal voltage 4 poles 240 V
5 poles 60 V
8 poles 30 V
Rated voltage 3-4 poles 250 V
5 poles 63 V
8 poles 36 V
Test voltage 3-4 poles 2.0 kV eff. / 60 s
5-8 poles 1.5 kV eff. / 60 s
Insulation resistance > 10⁹ Ω

Cable Specifications

Cable No.	Outer Jacket	Conductor Size	Jacket Color	OD
182	PVC, shielded	4 x 0.34 mm ²	Orange	.217" (5.5 mm)
183	PVC, shielded	5 x 0.34 mm ²	Orange	.236" (6.0 mm)
184	PVC, shielded	8 x 0.25 mm ²	Orange	.260" (6.6 mm)
288	PUR, halogen-free, shielded	4 x 0.34 mm ²	Black	.217" (5.5 mm)
298	PUR, halogen-free, shielded	5 x 0.34 mm ²	Black	.236" (6.0 mm)
299	PUR, halogen-free, shielded	8 x 0.25 mm ²	Black	.260" (6.6 mm)

RKWTH (8-pole version)



Part Number	Part Number	Pins	Outer Jacket	Standard Cable Lengths	Characteristics
Female Straight	Female 90°				
RKTS 4-182/...M	RKWTH 4-182/...M	4	PVC	2 M / 5 M / 10 M	
RKTS 4-288/...M	RKWTH 4-288/...M		PUR, halogen-free	2 M / 5 M / 10 M	   
RKTS 5-183/...M		5	PVC	2 M / 5 M / 10 M	
RKTS 5-298/...M	RKWTH 5-298/...M		PUR, halogen-free	2 M / 5 M / 10 M	   
RKTS 8-184/...M		8	PVC	2 M / 5 M / 10 M	
RKTS 8-299/...M	RKWTH 8-299/...M		PUR, halogen-free	2 M / 5 M / 10 M	   

X-ON Electronics

Largest Supplier of Electrical and Electronic Components

Click to view similar products for [Sensor Cables / Actuator Cables](#) category:

Click to view products by [Lumberg](#) manufacturer:

Other Similar products are found below :

[60963](#) [60964](#) [M83513/19-F01CP](#) [703000D02F2002](#) [703000D02F300](#) [703001D02F0602](#) [703001D02F300](#) [704000D02F120](#) [773032K02F030](#)
[802027107404-1](#) [804001A09M150](#) [805001A09M0502](#) [84914-0235](#) [84914-0237](#) [885030A09M020](#) [1200651332](#) [1200651713](#) [1200660844](#)
[1200660845](#) [1200661173](#) [1200680071](#) [1200720053](#) [1200720081](#) [1200720099](#) [1200720217](#) [1200800231](#) [1200860125](#) [1200870123](#)
[1200980102](#) [1200650267](#) [1200650298](#) [1200660183](#) [1200660782](#) [1200660849](#) [1200661295](#) [1200661297](#) [1200661342](#) [1200661343](#)
[1200670080](#) [1200670220](#) [1200680331](#) [1200720252](#) [1200730184](#) [1200860344](#) [1200870359](#) [1200870643](#) [1200980008](#) [1200980031](#)
[1210502211](#) [1210400542](#)