

**M12-Round-Plug Connector, Single-Ended Cordsets,  
According to IEC 61076-2-101**

RKTS | RKWTH



**4-, 5-, and 8-Poles (Shielded)**

Actuator/sensor cordset, single-ended, M12, 4-, 5-, and 8-poles, female straight connector, internal threads with threaded joint and molded cable, shielding connecting to knurled nut.

RKTS

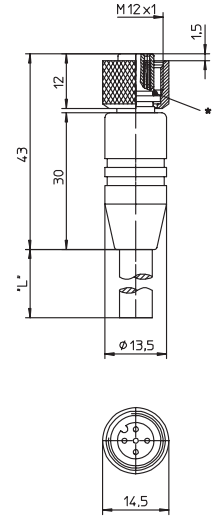

Actuator/sensor cordset, single-ended, M12, 4-, 5-, and 8-poles, female 90 °connector, internal threads with threaded joint and molded cable, shielding connecting to knurled nut.

RKWTH

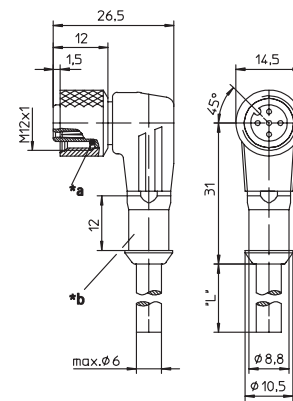

**Pin Assignments**

M12 - Female

**4 poles**

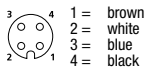

**5 poles**

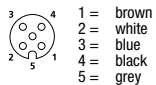

**8 poles**

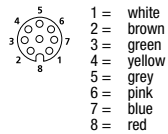



### M12-Round-Plug Connector, Single-Ended Cordsets, According to IEC 61076-2-101 RKTS | RKWTH

#### Technical Data

##### Environmental

Degree of protection IP 67 / NEMA 6P  
Operating temperature range -25°C (-13°F) / +80°C (+176°F)

##### Mechanical

Housing / Molded body TPU  
Insert TPU  
Contact CuSn, pre-nickel and 0.8 microns gold-plated  
Coupling nut CuZn, nickel-plated  
Shield sleeve CuZn, nickel-plated  
O-ring FKM

##### Electrical









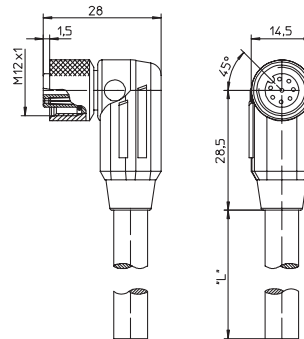





Contact resistance ≤ 5 mΩ  
Nominal current at 40°C 4 A  
Nominal voltage 4 poles 240 V  
5 poles 60 V  
8 poles 30 V  
Rated voltage 3-4 poles 250 V  
5 poles 63 V  
8 poles 36 V  
Test voltage 3-4 poles 2.0 kV eff. / 60 s  
5-8 poles 1.5 kV eff. / 60 s  
Insulation resistance > 10<sup>9</sup> Ω

#### Cable Specifications

| Cable No. | Outer Jacket                | Conductor Size           | Jacket Color | OD             |
|-----------|-----------------------------|--------------------------|--------------|----------------|
| 182       | PVC, shielded               | 4 x 0.34 mm <sup>2</sup> | Orange       | .217" (5.5 mm) |
| 183       | PVC, shielded               | 5 x 0.34 mm <sup>2</sup> | Orange       | .236" (6.0 mm) |
| 184       | PVC, shielded               | 8 x 0.25 mm <sup>2</sup> | Orange       | .260" (6.6 mm) |
| 288       | PUR, halogen-free, shielded | 4 x 0.34 mm <sup>2</sup> | Black        | .217" (5.5 mm) |
| 298       | PUR, halogen-free, shielded | 5 x 0.34 mm <sup>2</sup> | Black        | .236" (6.0 mm) |
| 299       | PUR, halogen-free, shielded | 8 x 0.25 mm <sup>2</sup> | Black        | .260" (6.6 mm) |

#### RKWTH (8-pole version)



| Part Number            | Part Number       | Pins | Outer Jacket      | Standard Cable Lengths | Characteristics   |
|------------------------|-------------------|------|-------------------|------------------------|---|
| <b>Female Straight</b> | <b>Female 90°</b> |      |                   |                        |   |
| RKTS 4-182/...M        | RKWTH 4-182/...M  | 4    | PVC               | 2 M / 5 M / 10 M       |    |
| RKTS 4-288/...M        | RKWTH 4-288/...M  |      | PUR, halogen-free | 2 M / 5 M / 10 M       |     |
| RKTS 5-183/...M        |                   | 5    | PVC               | 2 M / 5 M / 10 M       |    |
| RKTS 5-298/...M        | RKWTH 5-298/...M  |      | PUR, halogen-free | 2 M / 5 M / 10 M       |     |
| RKTS 8-184/...M        |                   | 8    | PVC               | 2 M / 5 M / 10 M       |    |
| RKTS 8-299/...M        | RKWTH 8-299/...M  |      | PUR, halogen-free | 2 M / 5 M / 10 M       |     |

## X-ON Electronics

Largest Supplier of Electrical and Electronic Components

*Click to view similar products for [Sensor Cables / Actuator Cables](#) category:*

*Click to view products by [Lumberg](#) manufacturer:*

Other Similar products are found below :

[60963](#) [60964](#) [703000D02F2002](#) [703000D02F300](#) [703001D02F0602](#) [703001D02F300](#) [704000D02F120](#) [773032K02F030](#) [802027107404-1](#)  
[802027213811-1](#) [804001A09M150](#) [805001A09M0502](#) [84914-0235](#) [84914-0237](#) [885030A09M020](#) [1200651332](#) [1200651713](#) [1200660844](#)  
[1200660845](#) [1200661173](#) [1200680071](#) [1200720053](#) [1200720081](#) [1200720099](#) [1200720217](#) [1200800231](#) [1200860125](#) [1200870123](#)  
[1200980102](#) [1200650267](#) [1200650298](#) [1200660183](#) [1200660782](#) [1200660849](#) [1200661295](#) [1200661297](#) [1200661342](#) [1200661343](#)  
[1200670080](#) [1200670220](#) [1200680331](#) [1200720252](#) [1200730184](#) [1200860344](#) [1200870359](#) [1200870643](#) [1200980008](#) [1200980031](#)  
[1210502211](#) [1210400542](#)