

**M12-Round-Plug Connector, Single-Ended Cordsets,  
According to IEC 60529**

RKWTS



**4-, 5-, and 8-Poles (360° Shielding)**

Actuator/sensor cordset, M12 female right angle connector with threaded joint and molded cable, 360° shielding connected to knurled nut

RKWTS

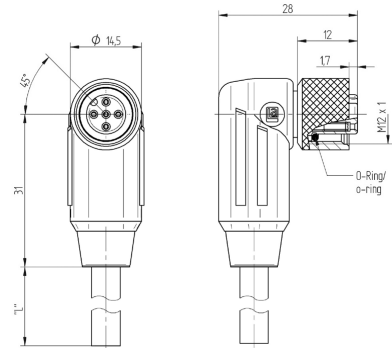

**Pin Assignments**

**M12 - Male**

**4 poles**

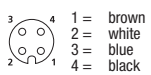

**5 poles**

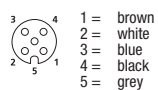

**8 poles**

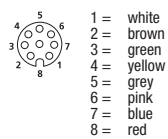



### M12-Round-Plug Connector, Single-Ended Cordsets, According to IEC 60529 RKWTS

#### Technical Data

##### Environmental

Degree of protection IP 67 / IP 68 / IP 69K  
Operating temperature range -25°C / +85°C

##### Mechanical































Housing / Molded body TPU, orange  
Insert PBT, black  
Contact 4 to 5 poles: CuSn  
8 poles: CuZn  
  
Contact surface Cu/Au  
Coupling nut CuZn, nickel-plated  
Shield sleeve CuZn, tin-plated  
O-ring FKM

##### Electrical

Contact resistance ≤ 5 mΩ  
Nominal current at 40°C 4 to 5 poles: 4 A  
8 poles: 2 A  
  
Rated voltage 4 poles: 240 V AC/DC  
5 poles 60 V AC/DC  
8 poles 30 V AC/DC  
  
Test voltage 4 poles 2.0 kV  
5–8 poles 1.5 kV  
  
Insulation resistance > 10<sup>9</sup> Ω  
Pollution degree 3 DIN EN 60664-1 (VDE0110)

#### Cable Specifications

Cable No.	Outer Jacket	Conductor Size	Jacket Color	OD
182	PVC, shielded	4 x 0.34 mm <sup>2</sup>	Orange	.217" (5.5 mm)
183	PVC, shielded	5 x 0.34 mm <sup>2</sup>	Orange	.236" (6.0 mm)
184	PVC, shielded	8 x 0.25 mm <sup>2</sup>	Orange	.260" (6.6 mm)
288	PUR, halogen-free, shielded	4 x 0.34 mm <sup>2</sup>	Black	.217" (5.5 mm)
298	PUR, halogen-free, shielded	5 x 0.34 mm <sup>2</sup>	Black	.236" (6.0 mm)
299	PUR, halogen-free, shielded	8 x 0.25 mm <sup>2</sup>	Black	.260" (6.6 mm)

Part Number	Pins	Outer Jacket	Standard Cable Lengths	Characteristics
<b>Female 90°</b>				
RKWTS 4-182/...M	4	PVC	1 M / 2 M / 5 M / 7 M / 10 M / 15 M / 25 M	    
RKWTS 4-288/...M		PUR, halogen-free	2 M / 5 M / 6 M / 10 M / 15 M / 20 M / 30 M	    
RKWTS 5-183/...M	5	PVC	2 M / 5 M / 10 M	    
RKWTS 5-298/...M		PUR, halogen-free	0.2 M / 2 M / 5 M / 10 M / 15 M / 20 M / 30 M	    
RKWTS 8-184/...M	8	PVC	2 M / 5 M	    
RKWTS 8-299/...M		PUR, halogen-free	2 M / 5 M / 10 M / 15 M / 20 M	    

## X-ON Electronics

Largest Supplier of Electrical and Electronic Components

*Click to view similar products for [Sensor Cables / Actuator Cables](#) category:*

*Click to view products by [Lumberg](#) manufacturer:*

Other Similar products are found below :

[1300070444](#) [43-10984](#) [M83513/19-F01CP](#) [704000D02F120](#) [MDM15SH001K](#) [MDM25PH003BF222](#) [802027107404-1](#) [885030A09M010](#)  
[885030A09M020](#) [1200650174](#) [1200651332](#) [1200651713](#) [1200660171](#) [1200660208](#) [1200660343](#) [1200660804](#) [1200660845](#) [1200660926](#)  
[1200660977](#) [1200661173](#) [1200661354](#) [120066-1712](#) [1200720053](#) [1200720099](#) [1200720153](#) [1200720172](#) [1200720217](#) [1200720226](#)  
[1200720251](#) [1200720285](#) [1200720296](#) [1200720404](#) [1200730148](#) [1200730378](#) [1200800231](#) [1200860112](#) [1200860121](#) [1200860125](#)  
[1200860337](#) [1200860365](#) [1200860420](#) [1200870046](#) [1200870123](#) [1200870248](#) [1200980102](#) [1200660181](#) [1200660183](#) [1200660827](#)  
[1200660849](#) [1200661170](#)