

M12-Round-Plug Connector, Single-Ended Cordsets, According to IEC 60529

RKWTS



4-, 5-, and 8-Poles (360° Shielding)

Actuator/sensor cordset, M12 female right angle connector with threaded joint and molded cable, 360° shielding connected to knurled nut

RKWTS

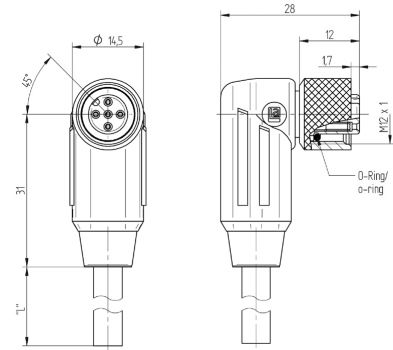

Pin Assignments

M12 - Male

4 poles

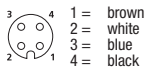

5 poles

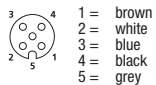

8 poles

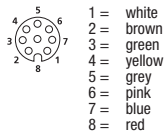



M12-Round-Plug Connector, Single-Ended Cordsets, According to IEC 60529 RKWTS

Technical Data

Environmental

Degree of protection IP 67 / IP 68 / IP 69K
Operating temperature range -25°C / +85°C

Mechanical

Housing / Molded body TPU, orange
Insert PBT, black
Contact 4 to 5 poles: CuSn
8 poles: CuZn

Contact surface Cu/Au
Coupling nut CuZn, nickel-plated
Shield sleeve CuZn, tin-plated
O-ring FKM

Electrical

Contact resistance ≤ 5 mΩ
Nominal current at 40°C 4 to 5 poles: 4 A
8 poles: 2 A































Rated voltage 4 poles: 240 V AC/DC
5 poles: 60 V AC/DC
8 poles: 30 V AC/DC

Test voltage 4 poles: 2.0 kV
5–8 poles: 1.5 kV

Insulation resistance > 10⁹ Ω
Pollution degree 3 DIN EN 60664-1 (VDE0110)

Cable Specifications

Cable No.	Outer Jacket	Conductor Size	Jacket Color	OD
182	PVC, shielded	4 x 0.34 mm ²	Orange	.217" (5.5 mm)
183	PVC, shielded	5 x 0.34 mm ²	Orange	.236" (6.0 mm)
184	PVC, shielded	8 x 0.25 mm ²	Orange	.260" (6.6 mm)
288	PUR, halogen-free, shielded	4 x 0.34 mm ²	Black	.217" (5.5 mm)
298	PUR, halogen-free, shielded	5 x 0.34 mm ²	Black	.236" (6.0 mm)
299	PUR, halogen-free, shielded	8 x 0.25 mm ²	Black	.260" (6.6 mm)

Part Number	Pins	Outer Jacket	Standard Cable Lengths	Characteristics
Female 90°				
RKWTS 4-182/...M	4	PVC	1 M / 2 M / 5 M / 7 M / 10 M / 15 M / 25 M	    
RKWTS 4-288/...M		PUR, halogen-free	2 M / 5 M / 6 M / 10 M / 15 M / 20 M / 30 M	    
RKWTS 5-183/...M	5	PVC	2 M / 5 M / 10 M	    
RKWTS 5-298/...M		PUR, halogen-free	0.2 M / 2 M / 5 M / 10 M / 15 M / 20 M / 30 M	    
RKWTS 8-184/...M	8	PVC	2 M / 5 M	    
RKWTS 8-299/...M		PUR, halogen-free	2 M / 5 M / 10 M / 15 M / 20 M	    

X-ON Electronics

Largest Supplier of Electrical and Electronic Components

Click to view similar products for [Sensor Cables / Actuator Cables](#) category:

Click to view products by [Lumberg](#) manufacturer:

Other Similar products are found below :

[60963](#) [60964](#) [M83513/19-F01CP](#) [703000D02F2002](#) [703000D02F300](#) [703001D02F0602](#) [703001D02F300](#) [704000D02F120](#) [773032K02F030](#)
[802027107404-1](#) [802027213811-1](#) [804001A09M150](#) [805001A09M0502](#) [84914-0235](#) [84914-0237](#) [885030A09M020](#) [1200651332](#)
[1200651713](#) [1200660844](#) [1200660845](#) [1200661173](#) [1200680071](#) [1200720053](#) [1200720081](#) [1200720099](#) [1200720217](#) [1200800231](#)
[1200860125](#) [1200870123](#) [1200980102](#) [1200650267](#) [1200650298](#) [1200660183](#) [1200660782](#) [1200660849](#) [1200661295](#) [1200661297](#)
[1200661342](#) [1200661343](#) [1200670080](#) [1200670220](#) [1200680331](#) [1200720252](#) [1200730184](#) [1200860344](#) [1200870359](#) [1200870643](#)
[1200980008](#) [1200980031](#) [1210502211](#)