

RSRK 20...50 | RSRKW 20...50



**Mini, 7/8\"/>**

**2-, 3-, 4- and 5-Poles**

Mini, 7/8" double-ended cordsets, male straight with external threads to female straight connector, 2-, 3-, 4-, and 5-poles with molded cable, IEC color code.

**RSRK**

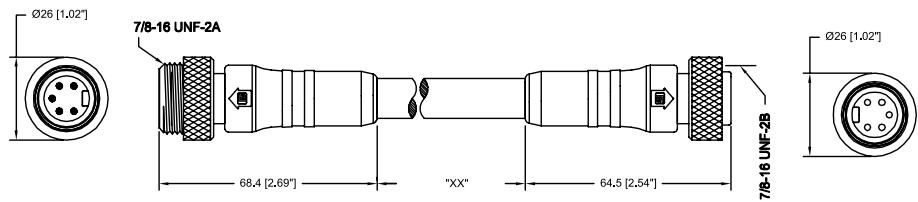

Mini, 7/8" double-ended cordsets, male straight with external threads to female 90° connector, 2-, 3-, 4-, and 5-poles with molded cable, IEC color code.

**RSRKW**

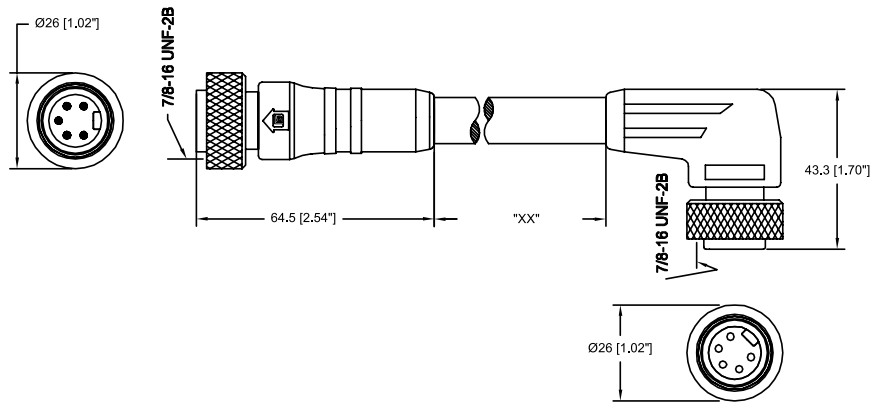

**Pin Assignments**

**Mini, 7/8\"/>**

**2 poles**

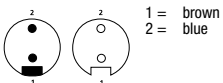

**3 poles**

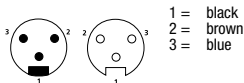

**4 poles**

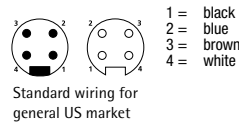
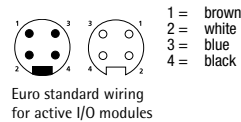

**5 poles**

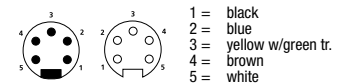

# Be Certain with Belden



Cordsets  
Double-Ended

## Mini, 7/8"-Round-Plug Connector, Double-Ended Cordsets, IEC Color Code RSRK 20...50 | RSRKW 20...50

### Technical Data

#### Environmental

Degree of protection IP 67 / NEMA 6P  
Operating temperature range -40°C (-40°F) / +90°C (194°F)

#### Mechanical

Housing / Molded body TPU, yellow  
Insert TPU, yellow  
Contact CuZn, gold over silver plated  
Coupling nut Aluminum, anodized black

#### Electrical

Current rating 2-3 pole: 8 A  
4-5 pole: 5.6 A  
Voltage rating 300 V

### Cable Specifications - IEC Color Code

Cable No.	Outer Jacket	Gauge	Jacket Color	OD	Temperature Rating	Agency Approvals
<b>602</b>	<b>PUR</b>	18AWG	Yellow	.230" (5.8 mm)	-40°C (-40°F) to +80°C (176°F)	UL: AWM 20233 / CSA: AWM I/II A/B
Continuous flex rating and suitable for general C-track usage. 1 million cycles at minimum bend radius 10X cable diameter.						
<b>603</b>	<b>PVC</b>	18AWG	Yellow	.290" (7.4 mm)	-40°C (-40°F) to +105°C (221°F)	UL: AWM 2661 / CSA: AWM I/II A/B
<b>637</b>	<b>TPE</b>	18AWG	Yellow	.280" (7.1 mm)	-40°C (-40°F) to +105°C (221°F)	UL: PLTC / CSA: AWM I/II A/B
<b>645</b>	<b>PUR</b>	18AWG	Yellow	.220" (5.6 mm)	-40°C (-40°F) to +80°C (176°F)	UL: AWM 20233 / CSA: AWM I/II A/B
<b>731</b>	<b>TPE</b>	18AWG	Yellow	.284" (7.2 mm)	-40°C (-40°F) to +90°C (194°F)	UL: PLTC / CSA: AWM I/II A/B
<b>794</b>	<b>TPE</b>	18AWG	Yellow	.304" (7.7 mm)	-40°C (-40°F) to +90°C (194°F)	UL: PLTC / CSA: AWM I/II A/B

Part Number	Pins	Outer Jacket	Standard Cable Lengths	Characteristics
RSRK 20-603/...M	2	PVC	0.3 M / 0.6 M / 1 M / 2 M / 5 M	
RSRK 30-731/...F	3	TPE	6 F / 12 F / 15 F / 20 F / 30 F	
RSRK 30-645/...M		PUR	0.3 M / 0.6 M / 1 M / 2 M / 5 M	
RSRK 40-637/...F	4	TPE	6 F / 12 F / 15 F / 20 F / 30 F	
RSRK 40-602/...M		PUR	0.3 M / 0.6 M / 1 M / 2 M / 5 M	
RSRK 50-794/...F	5	TPE	6 F / 12 F / 15 F / 20 F / 30 F	

## X-ON Electronics

Largest Supplier of Electrical and Electronic Components

*Click to view similar products for [Sensor Cables / Actuator Cables](#) category:*

*Click to view products by [Lumberg](#) manufacturer:*

Other Similar products are found below :

[60963](#) [60964](#) [M83513/19-F01CP](#) [703000D02F2002](#) [703000D02F300](#) [703001D02F0602](#) [703001D02F300](#) [704000D02F120](#) [773032K02F030](#)  
[802027107404-1](#) [804001A09M150](#) [805001A09M0502](#) [84914-0235](#) [84914-0237](#) [885030A09M020](#) [1200651332](#) [1200651713](#) [1200660844](#)  
[1200660845](#) [1200661173](#) [1200680071](#) [1200720053](#) [1200720081](#) [1200720099](#) [1200720217](#) [1200800231](#) [1200860125](#) [1200870123](#)  
[1200980102](#) [1200650267](#) [1200650298](#) [1200660183](#) [1200660782](#) [1200660849](#) [1200661295](#) [1200661297](#) [1200661342](#) [1200661343](#)  
[1200670080](#) [1200670220](#) [1200680331](#) [1200720252](#) [1200730184](#) [1200860344](#) [1200870359](#) [1200870643](#) [1200980008](#) [1200980031](#)  
[1210502211](#) [1210400542](#)