



ND40 - POWER NETWORK ANALYZER / RECORDER

- Measurement and recording of over 500 electric energy quality parameters acc. to EN 50160, EN 61000-4-30, EN 61000-4-7 standards.
- Measuring class A - for 3 second aggregation. 10 minute and 2 hour aggregation - class S.
- Operation in 3 or 4-wire, 3-phase, balanced or unbalanced power networks.
- Analysis of current and voltage harmonics up to the 51 st for class I (acc. to EN 61000-4-7).
- Configurable archives of actual values and event recording.
- Data archiving on an SD card - memory up to 32 GB.
- E-mail messages in case of alarm occurs,
- Web Server, FTP Server.
- Interfaces: RS-485 Modbus Slave, Ethernet 100 Base-T (Modbus TCP Server), USB Device & Host.
- Colour touch screen: LCD TFT 5.6", 640 x 480 pixels.
- IP65 protection grade from the frontal side.
- Synchronization of RTC clock with the NTP time server.



* for selected parameters - details in the technical data

EXAMPLE OF APPLICATION

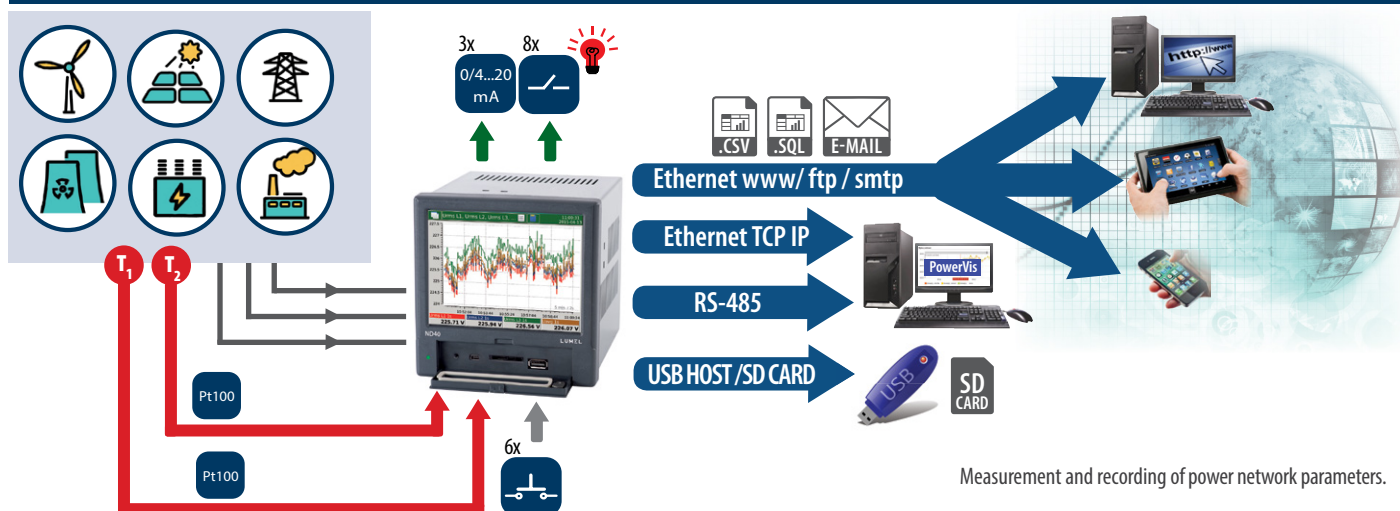

Measurement and recording of power network parameters.

MEASUREMENT AND VISUALIZATION OF POWER NETWORK PARAMETERS

Aggregated values for 3 seconds, 10 minutes and two hours:

- phase voltages $U_1, U_2, U_3, U_{123_avg}$
- phase current $I_1, I_2, I_3, I_{123_avg}$
- active phase powers $P_1, P_2, P_3, \Sigma P_{123}, P_{123_avg}$
- reactive phase powers $Q_1, Q_2, Q_3, \Sigma Q_{123}, Q_{123_avg}$
- apparent phase powers $S_1, S_2, S_3, \Sigma S_{123}, S_{123_avg}$
- active power factors $PF_1, PF_2, PF_3, PF_{123_avg}$
- power factor distortion $dPF_1, dPF_2, dPF_3, dPF_{123_avg}$
- reactive/active power factors $tg\phi_1, tg\phi_2, tg\phi_3, tg\phi_{123_avg}$
- phase-to-phase voltages $U_{12}, U_{31}, U_{23}, U_{123_avg}$
- current in neutral wire I_n
- the angle between the voltage and current $\phi_1, \phi_2, \phi_3, \phi_1, \phi_{123_avg}$ (degrees and radians)
- voltage phase-to-phase angle $\sphericalangle U_{12}, \sphericalangle U_{31}, \sphericalangle U_{23}, \sphericalangle U_{123_avg}$

Other parameters:

- frequency (aggregation for 1 and 10 seconds)
- temperature/ resistance values (two channels)
- Demand values: P, Q, S, U, I (15-minute, 30-minute or 1 hour).
- energy: active imported/exported, reactive imported/exported and apparent. All energies are calculated for each phase and 3-phase parameters.
- factors: THD, THDS, THDG, PWHD. Calculated for currents and voltages of each phase and 3-phase parameters.
- harmonics from 1 up to 51st for each phase of currents and voltages
- the half wave voltage of each phase
- recording of dips, swells and overvoltages
- storage of minimum and maximum of measured values.

FEATURES	INPUTS	OUTPUTS	GALVANIC ISOLATION

TECHNICAL DATA

INPUTS

Input type	Measuring range	Parameters	Basic error
Voltage input	230/400 V 57,7/100V	0.05..1.5 Un	± 0.1%
Current input	1 A or 5A	0.005..1.5 In	± 0.1%
Logic input	6 logic inputs: 0/5..24 V d.c.	switching frequency up to 50 Hz	
Input for temperature measurement	Pt100: -200...850°C, Pt1000: -200...850°C , resistance: 0...5000 Ω		± 0.2%

OUTPUTS

Output type	Properties
Analog output	3 programmable current outputs 0/4...20 mA, load resistance < 500 Ω
Relay output	8 programmable electromagnetic relays, voltageless NO contacts, load capacity 250 V a.c./1 A a.c.

DIGITAL INTERFACES

Interface type	Properties
RS-485	interface: MODBUS Slave, baud rate 300...115200 bit/s, transmission mode RTU
USB	2 interfaces: Device & Host, USB v.2.0
Ethernet	100 Base-T, RJ45 socket, Modbus TCP Server

RATED OPERATING CONDITIONS

Supply voltage	85 V..240 V a.c., 40...400Hz 90 V..320 V d.c.	power consumption: 15 VA, 35 VA (when loading)
Ambient temperature	work: 0 up to 50°C	storage: - 20...50°C
Relative humidity	< 75%	Condensation inadmissible
Reaction against	supply decays supply recovery	Data and device state preservation Continuation of device work
Short term load (5s)	2 Un (max. 1000 V)	10 In
Casing protection grade	IP 65	
Safety requirements	Installation category III Pollution grade 2	EN 61010-1
Maximum phase-to-earth operating voltage	RS485, temperature/resistance input, USB: 50V measuring circuit, relays, supply: 300 V	EN 61010-1

MEASURING RANGES AND ADMISSIBLE BASIC CONVERSION ERRORS

Measuring quantity	Measurement method	Range	Basic error
Voltage U RMS	U RMS averaged values: 1 s class: B 3 s class: A 10 min class: S 2 hrs class: S	U RMS L-N (150% Un) Un = 230 V 23.0..46..345.0 V (Ku=1) ..480.0 kV (Ku≠1) Un = 57.7 V 5.7..11.5 ..70.0 V (Ku=1) U RMS L-L (150% Un): Un = 400 V 40.0..80.. 600.0 V (Ku=1) ..1020.0 kV (Ku≠1) Un = 100V 10.0 ..20..120.0 V (Ku=1)	class A acc. to EN 61000-4-30:2008 U RMS L-N (10% U _{din} - 150% U _{din}): ±0.1% U _{din} .
Current I RMS	I RMS : averaged values: 1 s class: B 3 s class: A 10 min class: S 2 hrs class: S	I RMS (150% In) : In = 1 A - 0.010..0.1..1.5 A (Ki=1) In = 5 A - 0.050..0.5..7.5 A (Ki=1) ..480.0 kA (Ki≠1)	I RMS (10% In - 150% In): ±0.1% of measurement
Frequency	Class S appointed from 10 or 12 cycles in 200 ms. Class A appointed from 100 or 120 cycles in 10 s.	42.5 up to 57.5 Hz for 50 Hz a.c. of supply 51.0 up to 69.0 Hz for 60 Hz a.c. of supply	Class S acc. to EN 61000-4-30:2008 ±0.050 Hz Class A acc. to EN 61000-4-30:2008 ±0.010 Hz

Active, reactive and apparent power	Active power: Measured every 10 cycles (50 Hz) or 12 cycles (60 Hz) Reactive power: appointed from apparent and active power. Apparent power: appointed from value U RMS and I RMS.	Depends on voltage and actual ratio value.	acc. to EN 61557-12: Active power: $\pm 0.5\% P_n$ Reactive power: $\pm 1\% Q_n$ Apparent power: $\pm 0.5\% S_n$
Measuring quantity	Measurement method	Range	Basic error
Active imported/exported energy, reactive imported/exported energy, apparent energy	Measured every 10 cycles (50 Hz) or 12 cycles (60 Hz). Separate measurement for exported, imported active and reactive energy .	Depends on voltage and actual ratio value.	acc. to EN 61557-12: Active power: $\pm 0.5\%$ Reactive power: $\pm 1\%$ Apparent power: $\pm 2\%$
Active power factor, Power distortion factor	Active power factor : depends on U RMS, I RMS and active power. Power distortion factor depends on THD I.	-1,000 .. 0 .. 1,000	Power factor PF $\pm 0.01\%$ Power distortion factor PFdist $\pm 0.05\%$
Harmonics of voltages and current	acc. to EN 61000-4-7:2007, up to 51st harmonic Window: 10 cycles (for 50 Hz), 12 cycles (for 60 Hz). FFT: 4096 points	Voltage harmonics: 0.00 .. 100.00 % Current harmonics: 0.00 .. 100.00 %	Voltage harmonics – class II $\pm 5\% U_{rdg}$ if $U_{rdg} > 1\%$ $\pm 0.05\% U_n$ if $U_{rdg} < 1\%$ Current harmonics – class II $\pm 5\% U_{rdg}$ if $U_{rdg} > 3\%$ $\pm 0.5\% U_n$ if $U_{rdg} < 3\%$
THD U, THD I, THDG U, THDG I, THDS U, THDS I, PWHD U, PWHD I	acc. to EN 61000-4-7:2007, up to 51st harmonic Window: 10 cycles (for 50 Hz), 12 cycles (for 60 Hz). FFT: 4096 points	THD U: 0.00 .. 100.00 % THD I: 0.00 .. 100.00 % THDG U: 0.00 .. 100.00 % THDG I: 0.00 .. 100.00 % THDS U: 0.00 .. 100.00 % THDS I: 0.00 .. 100.00 % PWHD U: 0.00 .. 100.00 % PWHD I: 0.00 .. 100.00 %	THD U: $\pm 5\%$ (50/60Hz) THD I: $\pm 5\%$ (50/60Hz) THDG U: $\pm 5\%$ (50/60Hz) THDG I: $\pm 5\%$ (50/60Hz) THDS U: $\pm 5\%$ (50/60Hz) THDS I: $\pm 5\%$ (50/60Hz) PWHD U: $\pm 5\%$ (50/60Hz) PWHD I: $\pm 5\%$ (50/60Hz)

where:

- Ku - voltage transformer ratio
- Ki - current transformer ratio
- Udin - declared input voltage
- Urdg, Irdg - measurement values
- Un, In, Pn, Qn - nominal values

EXAMPLES OF MEASURING DATA PRESENTATION

Various forms of data display:

- digital display
- analog view,
- bargraphs,
- vector diagrams
- trends
- energy meter
- harmonics analysis
- energy meter.

Screen system log files.

Screens log alarms.

Control panel.

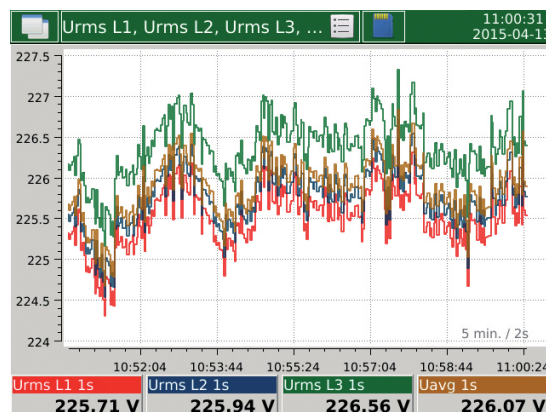
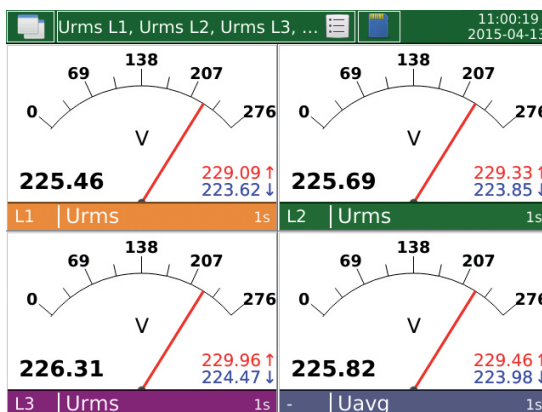
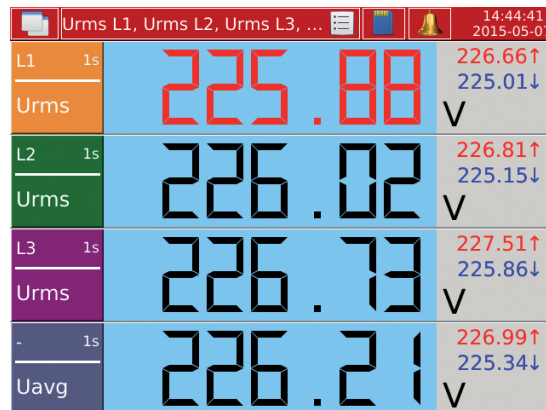
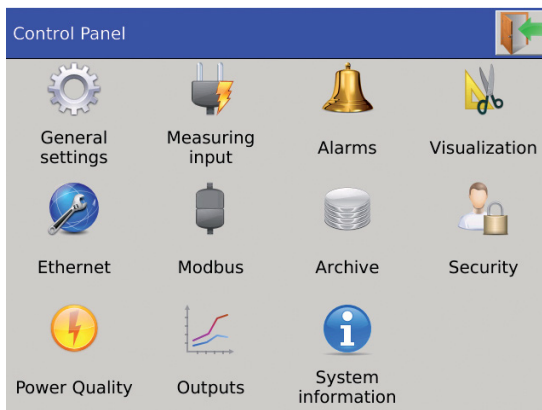

EXAMPLES OF MEASURING DATA PRESENTATION

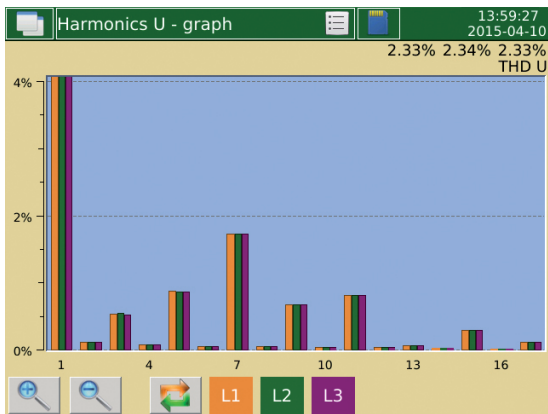
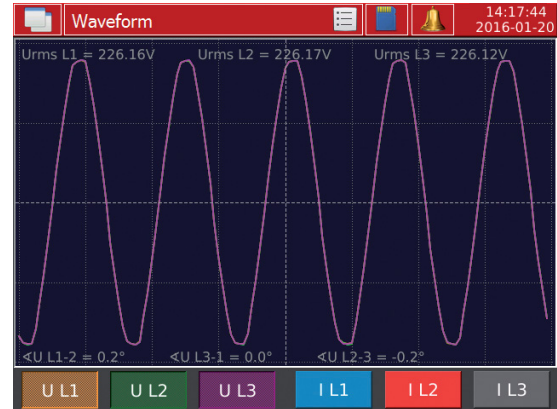
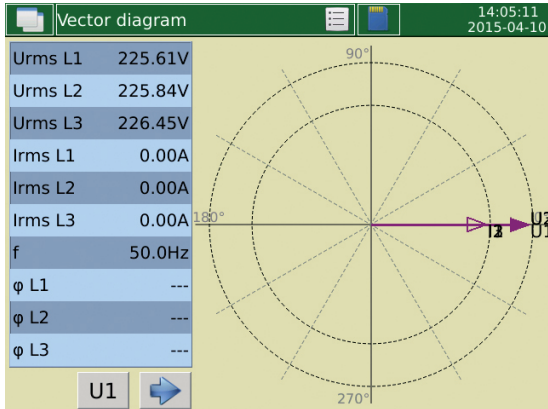

	L1 [%]	L2 [%]	L3 [%]
THD	2.34	2.35	2.34
THDG	2.34	2.35	2.34
THDS	0.00	0.00	0.00
PWHD	2.34	2.35	2.34
1	100.00	100.00	100.00
2	0.05	0.04	0.05
3	0.78	0.79	0.78
4	0.02	0.02	0.02
5	0.63	0.63	0.63
6	0.02	0.02	0.02
7	1.78	1.79	1.78
8	0.03	0.03	0.03
9	0.66	0.66	0.66
10	0.03	0.03	0.03

	value	unit
Σ EnP+	00000000.0	kWh
L1	00000000.0	kWh
L2	00000000.0	kWh
L3	00000000.0	kWh
Σ EnP-	00000000.0	kWh
L1	00000000.0	kWh
L2	00000000.0	kWh
L3	00000000.0	kWh
Σ EnQ+	00000000.0	kVARh
L1	00000000.0	kVARh

	B1 1		B2 0
	B3 0		B4 0
	B5 0		B6 0

No	Date	Time	Description
43	2016-01-20	13:49:54	Alarm 2 - Wt. (Urms L2 200ms 224.811V) (> 210)
42	2016-01-20	13:49:54	Alarm 1 - Wt. (Urms L1 200ms 224.823V) (> 200)
41	2016-01-20	08:53:15	Alarm 1 - Wt. (Urms L1 200ms 240.477V) (> 200)
40	2016-01-19	16:00:19	Alarm 2 - Wt. (Urms L2 200ms 229.91V) (> 210)
39	2016-01-19	16:00:19	Alarm 1 - Wt. (Urms L1 200ms 229.898V) (> 200)
38	2016-01-19	15:36:32	Alarm 2 - Wt. (Urms L2 200ms 228.824V) (> 210)
37	2016-01-19	15:36:31	Alarm 1 - Wt. (Urms L1 200ms 228.798V) (> 200)

ETHERNET: WWW SERVER, FTP

The screenshot displays the LUMEL ND40 Meter web interface. It is divided into several sections:

- Measurement data:** A table showing various power and voltage measurements over a 1s interval.
- Alarms:** A section for active alarms, currently showing 'Alarm 1 (Urms L1 200ms = 226.501V) (> 0.0)' with a 'Confirm' button.
- Files / ND40:** A file browser showing a configuration file 'Config_20160420_1026 ND40' with a size of 10.7 kB.
- System information:** A table providing details about the device, including its name, description, serial number, and version.
- Index of ftp://10.0.1.84/ND40/:** A file listing table showing various data files and logs.

Name	Value
Urms L1 1s	226.07V
Urms L2 1s	226.10V
Urms L3 1s	226.04V
Irms L1 1s	0.0603A
Irms L2 1s	0.0603A
Irms L3 1s	0.0603A
Pavg 1s	0.0071kW
ΣP 1s	0.0214kW
ΣQ 1s	-0.0349kvar
ΣS 1s	0.0409kVA
PFavg 1s	0.52
Umavg 1s	0.2533V

Name	Size	Data Modified
2015-07-15 08_49_41.ND40Arch	35 KB	2015-07-15 08:55:00
2015-07-15 08_55_40.ND40Arch	35 KB	2015-07-15 09:01:00
2015-07-15 09_01_40.ND40Arch	35 KB	2015-07-15 09:07:00
2015-07-15 09_07_35.ND40Arch	35 KB	2015-07-15 09:13:00
alarm.log.csv	2 KB	2015-07-15 09:21:00
audit.log.csv	2 KB	2015-07-15 09:22:00

Parameter	Value
Device name	ND40
Device description	Power Analyzer
Serial number	16010002
System version	0.2.11
Used space on SD card	

DIMENSIONS AND ASSEMBLY

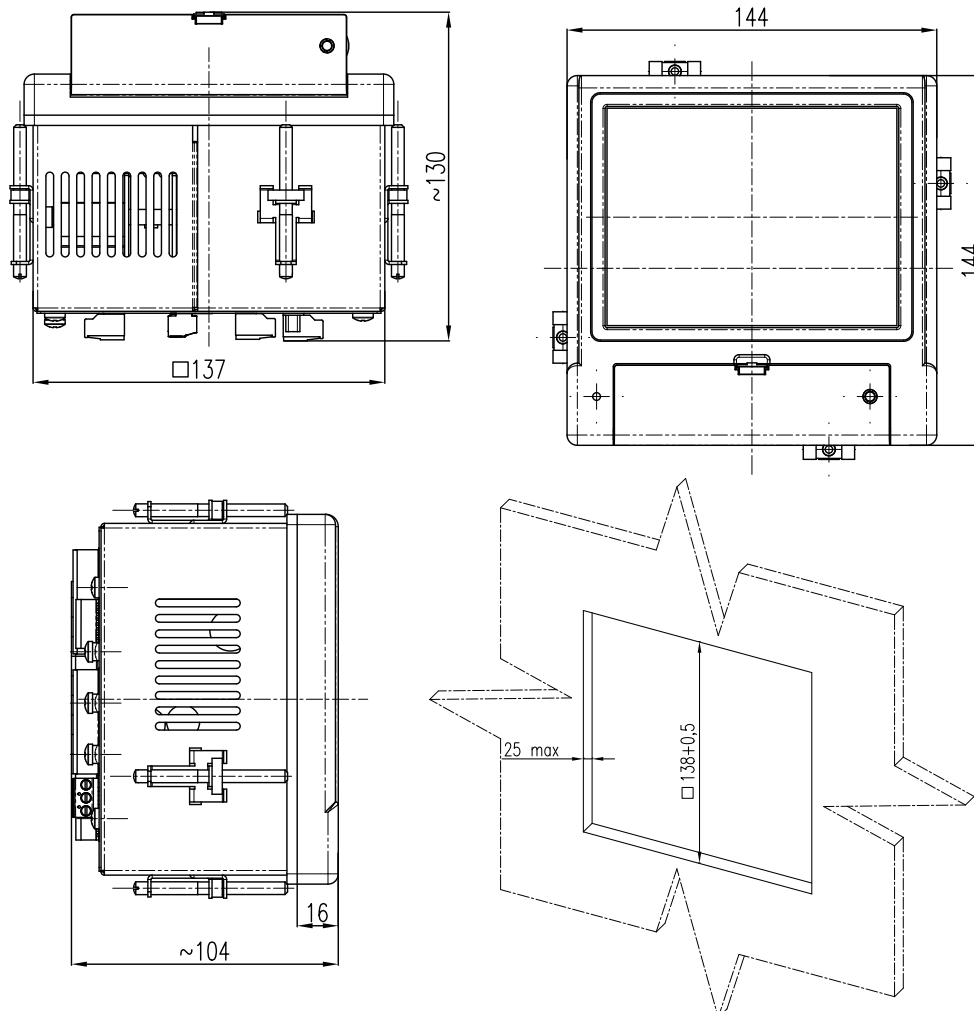

ORDERING CODE

Analyzer/recorder ND40 -	X	X	XX	X	X
Class:					
class S	0				
class A/S	1				
Inputs / outputs:					
whitout	0				
8 relay outputs	1				
6 logic inputs, 4 relay outputs	2				
6 logic inputs, 3 analog outputs	3				
Version:					
standard			00		
voltage input 3 x 57.7/ 100 V			01		
custom-made			XX		
Language:					
Polish				P	
English				E	
German				D	
Russian				R	
other*				X	
Acceptance tests:					
without additional quality requirements					0
with an extra quality inspection certificate					1
acc.to customer's request*					X

Order example:

The code: **ND40 - 0 1 00 E 0** means:

- ND40** - analyzer/ recorder ND40
- 0** - class S
- 1** - 8 relay outputs
- 00** - standard version
- E** - user's manual in English
- 0** - without additional quality requirements.

* only after agreeing with the manufacturer

SEE ALSO:



ND30 - power network meter with Ethernet and recording



RE92 - dual loop controller



P30U - universal transducer of temperature and standard signals



ND20 - power network meter



N43 - rail mounted 3-phase power network meter



P43 - 3-phase transducer of power network parameters



Current transformers from 5 A up to 6 kA



PowerVis - process visualization software



Free **eCON** software

For more information about Lumel products please visit our website:

www.lumel.com.pl

Join us at Facebook!



X-ON Electronics

Largest Supplier of Electrical and Electronic Components

Click to view similar products for [Digital Panel Meters](#) category:

Click to view products by [LUMEL](#) manufacturer:

Other Similar products are found below :

[M00558-00](#) [01.098.1658.1](#) [70.360.4828.0](#) [72331-00](#) [85310-25](#) [86427-26](#) [86642-00](#) [87268-13](#) [87316-00](#) [87719-26](#) [98107-56](#) [HB8260-R36-90](#) [DMS-20ACV-3-R-C](#) [EM11DINAV81XR1X](#) [25.325.3253.1](#) [25.325.4253.1](#) [25.330.0453.1](#) [25.350.0553.0](#) [20046-20](#) [20182-23](#) [AP1020](#) [AP1021](#) [25.320.5053.0](#) [25.350.3453.1](#) [25.394.3653.1](#) [25.521.3253.0](#) [28006-01](#) [04.630.1080.0](#) [20078-20](#) [EM11DINAV81XO1X](#) [85874-26](#) [87166-00](#) [87895-00](#) [28000-03](#) [K3GN-NDT1-FLK 24VDC](#) [82322K-11](#) [86641-00](#) [87004-00](#) [MV15-DC-20V-110V-CU](#) [HB8260R4890](#) [20125-21](#) [86640-00](#) [2CMA100166R1000](#) [N27D 00M0](#) [DMG 100](#) [DMG 110](#) [DMG 800 L01](#) [DMK 01](#) [DMK 01 R1](#) [DMK 11](#)