

UNCONTROLLED DOCUMENT

PART NUMBER		REV.
LDD-A5642RI		A
REV.	E.C.N. NUMBER AND REVISION COMMENTS	DATE
A	E.C.N. #11148.	4.27.07

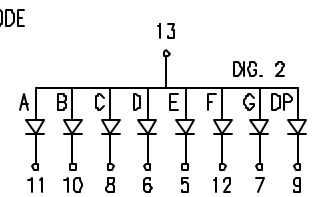
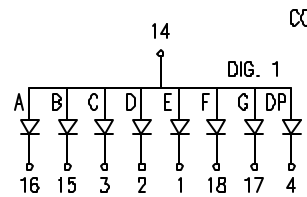
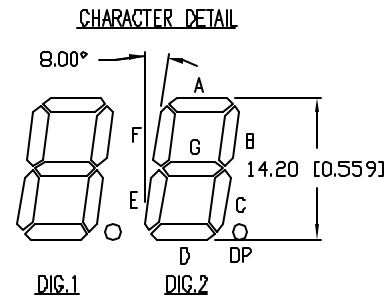
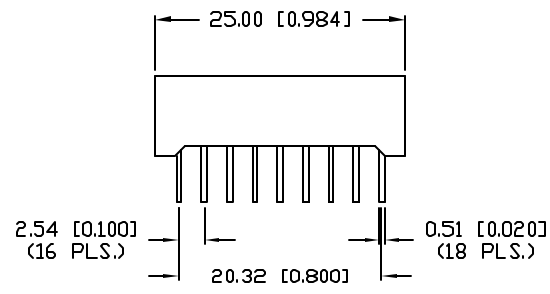
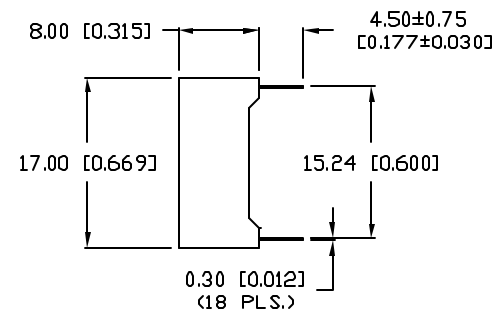
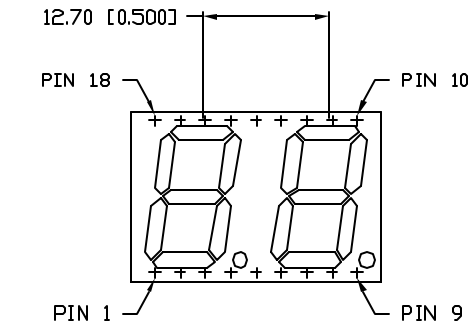

ELECTRO-OPTICAL CHARACTERISTICS  $T_A=25^{\circ}\text{C}$   $I_f=10\text{mA}$

PARAMETER	MIN	TYP	MAX	UNITS	TEST COND
PEAK WAVELENGTH		565 (GREEN)		nm	
FORWARD VOLTAGE		2.2	2.6	$V_f$	
REVERSE VOLTAGE	5.0			$V_r$	$I_r=100\mu\text{A}$
AXIAL INTENSITY		3900		$\mu\text{cd}$	$I_f=10\text{mA}$
EMITTED COLOR:	GREEN				
FACE COLOR:	GRAY				
SEGMENT COLOR:	MILKY WHITE DIFFUSED				

LIMITS OF SAFE OPERATION AT 25°C PER CHIP

PARAMETER	MAX	UNITS
PEAK FORWARD CURRENT*	150	mA
STEADY CURRENT	25	mA
POWER DISSIPATION	105	mW
DERATE FROM 25°C	-1.6	mW/°C
OPERATING, STORAGE TEMP.	-40 TO +85	°C
SOLDERING TEMP.	+260	°C
2.0mm FROM BODY	3 SEC. MAX	

\*  $t < 10\mu\text{s}$

REPLACES PART#: LDD-A542RI

\*UNLESS OTHERWISE SPECIFIED TOLERANCES PER DECIMAL PRECISION ARE: X=±1 (±0.039), X.X=±0.5 (±0.020), X.XX=±0.25 (±0.010), X.XXX=±0.127 (±0.005). LEAD SIZE=±0.05 (±0.002), LEAD LENGTH=±0.75 (±0.030). MIN=-0.00, MAX.=+0.00

REV.	PART NUMBER
A	LDD-A5642RI

CONFIDENTIAL INFORMATION  
 THE INFORMATION CONTAINED IN THIS DOCUMENT IS THE PROPERTY OF LUMEX INC. EXCEPT AS SPECIFICALLY AUTHORIZED IN WRITING BY LUMEX INC, THE HOLDER OF THIS DOCUMENT SHALL KEEP ALL INFORMATION CONTAINED HEREIN CONFIDENTIAL AND SHALL PROTECT SAME IN WHOLE OR IN PART FROM DISCLOSURE AND DISSEMINATION TO ALL THIRD PARTIES.



290 E. HELEN ROAD  
 PALATINE, IL 60067-6976  
 PHONE: +1.847.359.2790  
 US WEB: www.lumex.com  
 TW WEB: www.lumex.com.tw

0.56" SEVEN SEGMENT, DUAL DIGIT DISPLAY, 565nm GREEN CHIPS WITH MILKY WHITE DIFFUSED SEGMENTS, GRAY FACE.

RELIABILITY NOTE  
 OUR MANY YEARS OF EXPERIENCE DATA ACCUMULATION INDICATE THAT SOLDER HEAT IS A MAJOR CAUSE OF EARLY AND FUTURE FAILURE. PLEASE PAY ATTENTION TO YOUR SOLDERING PROCESS.

DRAWN BY:	CHECKED BY:	APPROVED BY:	DATE: 8.26.98
JC			PAGE: 1 OF 1
			SCALE: N/A

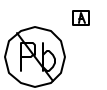

## X-ON Electronics

Largest Supplier of Electrical and Electronic Components

*Click to view similar products for [LED Displays & Accessories](#) category:*

*Click to view products by [Lumex](#) manufacturer:*

Other Similar products are found below :

[LTC-4624JD](#) [LTC-4627WC](#) [LTC-571P](#) [LTM-8522G](#) [LTP-4323P](#) [LTP-747G](#) [LTS-3361JG-06](#) [1668](#) [HT-F196NB-5323](#) [IPD2131-27](#) [SA03-12EWA](#) [LDQ-N514RI](#) [LDS-A3506RD](#) [LDS-A3926RI](#) [SC03-12HDB](#) [SI-B9T151550WW](#) [SI-B9V171550WW](#) [SLC-3PF-WL](#) [SLDN-32M-G1624](#) [LTC-2621JD](#) [LTC-2623WC](#) [LTC-4627JD](#) [LTD-322G](#) [LTD-482PC](#) [LTP-1057AHR](#) [LTP-1457AKR](#) [LTP-3784G-01](#) [LTS-313AP](#) [LTS-4812SKR-P](#) [LTS-547AE](#) [LTS-6780P](#) [446010401-3](#) [HV-7W30-6829](#) [DA43-11GWA](#) [LDD-A516RI-17](#) [LDD-E305RI](#) [LDQ-N3402RI](#) [LDQ-N3606RI](#) [LDT-M2804RI](#) [86004CB830](#) [LTP-3862JD](#) [LTP-2088AKD](#) [LTD-6740P](#) [LTS-6880Y](#) [LDS-SMC3002RISUGTR](#) [LTC-2623E](#)  
[CC25-12YWA](#) [LDM-6432-P3-UR-1](#) [SR420312N/32](#)