

PART NUMBER		SML-LX23SOC-TR	REV	E
REV	E.C.N. NUMBER AND REVISION COMMENTS			DATE
A	E.C.N. #10967.			03.14.03
B	E.C.N. #11148.			02.08.05
C	E.C.N. #11603.			12.14.09
D	E.C.N. #10BRDR & REDRAWN.			03.28.11
E	ECN-Lumex201800048			03.20.18

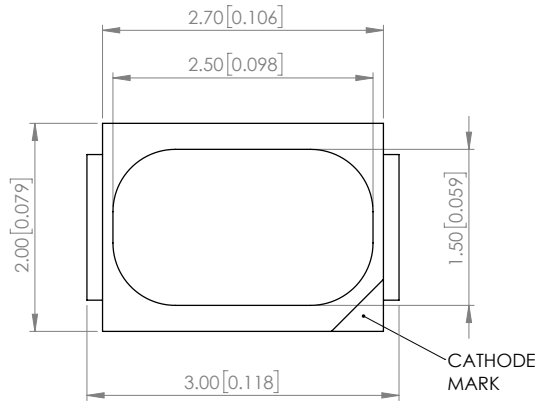

POLARITY

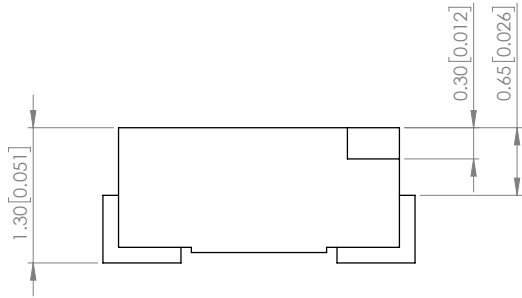
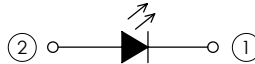

RECOMMENDED SOLDER PAD LAYOUT

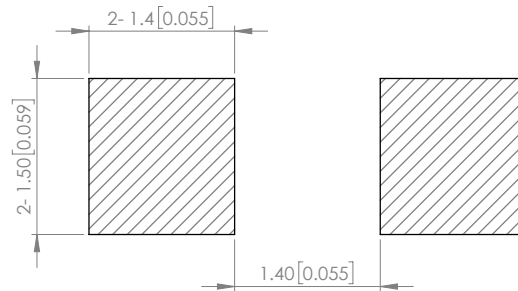
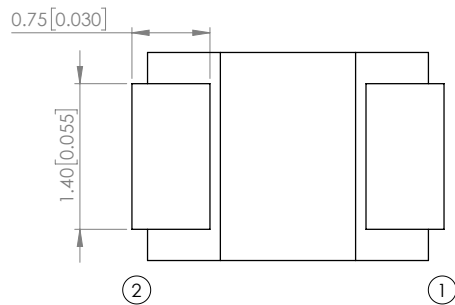

ELECTRO-OPTICAL CHARACTERISTIC TA=25°C

PARAMETER	MIN	TYP	MAX	UNITS	TEST COND
PEAK WAVELENGTH	-	610	-	-	If=20mA
FORWARD VOLTAGE	-	2.0	2.5	Vf	If=20mA
REVERSE VOLTAGE	-	-	10	uA	VR=5V
LUMINOUS INTENSITY	-	300	-	mcd	If=20mA
VIEWING ANGLE	-	120	-	2x theta1/2	-
EMITTED COLOR	ORANGE				
EPOXY LENS FINISH	WATER CLEAR				

ABSOLUTE MAXIMUM RATINGS TA=25°C

PARAMETER	MAX	UNITS
PEAK FORWARD CURRENT*	160	mA
FORWARD CURRENT	30	mA
REVERSE VOLTAGE	5	V
POWER DISSIPATION	75	mW
STORAGE TEMPERATURE	-40 TO +85	°C
OPERATING TEMPERATURE	-40 TO +85	°C

*t<10us.

NOTE:

1. RoHS COMPLIANT.
2. PACKAGE : 2000 PCS/REEL.

STATIC DEVICE FOLLOW PROPER E.S.D. HANDLING PROCEDURES WHEN WORKING WITH THIS PART

*UNLESS OTHERWISE SPECIFIED TOLERANCES PER DECIMAL PRECISION ARE: X=±1 (±0.039), X.X=±0.5 (±0.020), X.XX=±0.25 (±0.010), X.XXX=±0.127 (±0.005). LEAD SIZE=±0.05 (±0.002), LEAD LENGTH=±0.75 (±0.030). MIN=+DECIMAL PRECISION -0.00, MAX.=+0.00 -DECIMAL PRECISION



425 N. GARY AVE.
CAROL STREAM, IL 60188
PHONE : 800-278-5666
FAX : 630-315-2150
WEB : WWW.LUMEX.COM

3(L)*2(W)*1.3(H)mm, SURFACE MOUNT WITH REFLECTOR, AlGaInP 610nm ORANGE, WATER CLEAR LENS, TAPE & REEL
 THE SPECIFICATIONS MAY CHANGE AT ANY TIME WITHOUT NOTICE DUE TO NEW MATERIALS OR PRODUCT IMPROVEMENT.
 CONFIDENTIAL INFORMATION
 THE INFORMATION CONTAINED IN THIS DOCUMENT IS THE PROPERTY OF LUMEX INC. EXCEPT AS SPECIFICALLY AUTHORIZED IN WRITING BY LUMEX INC., THE HOLDER OF THIS DOCUMENT SHALL KEEP ALL INFORMATION CONTAINED HEREIN CONFIDENTIAL AND SHALL PROTECT SAME IN WHOLE OR IN PART FROM DISCLOSURE AND DISSEMINATION TO ALL THIRD PARTIES.

DATE : 2018.03.20	DRAWN BY : C.C.
PAGE : 1 OF 2	CHKD BY : E.C.
SCALE : NTF	APRVD BY : G.Y.
UNIT : mm [INCH]	Ⓢ

PROFILE

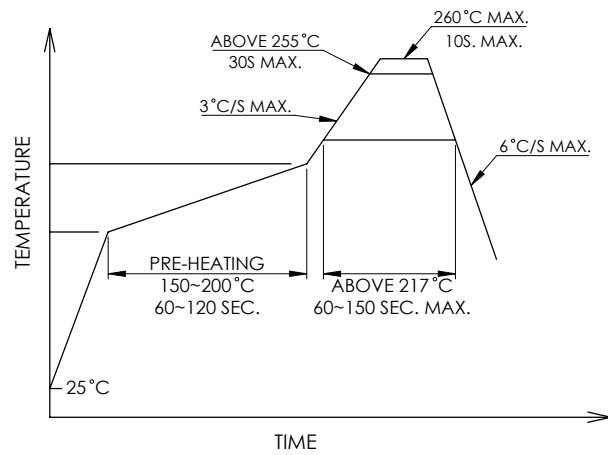

CARRIER TAPE DIMENSION

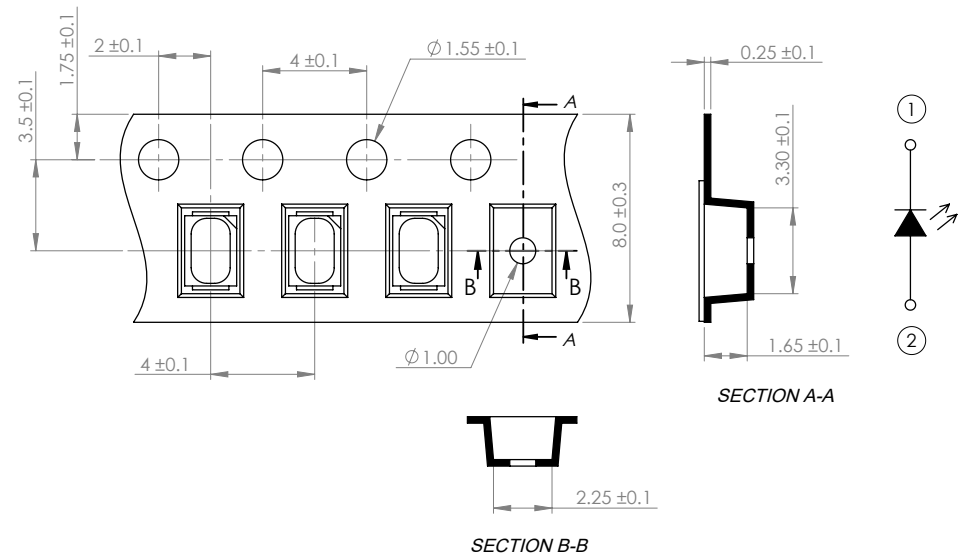

*UNLESS OTHERWISE SPECIFIED TOLERANCES PER DECIMAL PRECISION ARE: X=±1 (±0.039), X.X=±0.5 (±0.020), X.XX=±0.25 (±0.010), X.XXX=±0.127 (±0.005). LEAD SIZE=±0.05 (±0.002), LEAD LENGTH=±0.75 (±0.030). MIN=+DECIMAL PRECISION -0.00, MAX.=+0.00 -DECIMAL PRECISION

	425 N. GARY AVE. CAROL STREAM, IL 60188 PHONE : 800-278-5666 FAX : 630-315-2150 WEB : WWW.LUMEX.COM	3(L)*2(W)*1.3(H)mm, SURFACE MOUNT WITH REFLECTOR, AlGaInP 610nm ORANGE, WATER CLEAR LENS, TAPE & REEL	DATE : 2018.03.20	DRAWN BY : C.C.
		THE SPECIFICATIONS MAY CHANGE AT ANY TIME WITHOUT NOTICE DUE TO NEW MATERIALS OR PRODUCT IMPROVEMENT.	PAGE : 2 OF 2	CHKD BY : E.C.
		CONFIDENTIAL INFORMATION THE INFORMATION CONTAINED IN THIS DOCUMENT IS THE PROPERTY OF LUMEX INC. EXCEPT AS SPECIFICALLY AUTHORIZED IN WRITING BY LUMEX INC., THE HOLDER OF THIS DOCUMENT SHALL KEEP ALL INFORMATION CONTAINED HEREIN CONFIDENTIAL AND SHALL PROTECT SAME IN WHOLE OR IN PART FROM DISCLOSURE AND DISSEMINATION TO ALL THIRD PARTIES.	SCALE : NTF	APRVD BY : G.Y.
			UNIT : mm [INCH]	

X-ON Electronics

Largest Supplier of Electrical and Electronic Components

Click to view similar products for [Standard LEDs - SMD category](#):

Click to view products by [Lumex manufacturer](#):

Other Similar products are found below :

[LTST-C190KYKT](#) [LTST-C19GD2WT](#) [LTST-N683GBEW](#) [LTW-170ZDC](#) [LTW-M140SZS40](#) [598-8110-100F](#) [598-8170-100F](#) [598-8610-202F](#) [67-22VRVGC/TR8](#) [AAAF5060QBFSEEZGS](#) [HLMA-QG00-S0021](#) [HLMP-6305-L0011](#) [ALMD-LB36-SV002](#) [APT1608QGW](#) [15-21UYC/S530-A3/TR8](#) [EAST2012YA0](#) [EASV1803BA0](#) [LG M67K-H1J2-24-0-2-R18-Z](#) [LS A676-P2S1-1](#) [SML310BATT86](#) [SML-LX0606SISUGC/A](#) [SML-LXL1307SRC-TR](#) [SML-LXR851SIUPGUBC](#) [LT1ED53A](#) [FAT801-S](#) [AM27ZGC03](#) [APB3025SGNC](#) [APFA3010SURKCGKQBDC](#) [APHK1608VGCA](#) [APT2012QGW](#) [LTST-C250KGKT](#) [LTW-010DCG](#) [LTW-020ZDCG](#) [LTW-21TS5](#) [LTW-220DS5](#) [LY L29K-H1J2-26](#) [UYGT801-S](#) [42-21UYC/S530-A3/TR8](#) [LO T67F-V1AB-24-1](#) [YGFR411-H](#) [598-8330-117F](#) [SML-LX0402IC-TR](#) [CMDA20AYAA7D1S](#) [CMDA16AYDR7A1X](#) [598-8040-100F](#) [598-8070-100F](#) [598-8140-100F](#) [598-8610-200F](#) [EAST2012GA0](#) [EAPL3527GA5](#)