

# SignalSure 75

## Mid power solution

SignalSure 75 is a compact, surface-mount, mid power LED signaling solution that delivers an elevated standard of light output, flux density, and color uniformity. SignalSure's robust design structure, coupled with high performance specifications, ensures high quality and reliability. SignalSure 75 is AEC-Q101D qualified.

SignalSure 75 is available in the following color wavelengths:

- Amber (591nm)
- Red Orange (615nm)
- Super Red (630nm)
- Super Red (635nm)

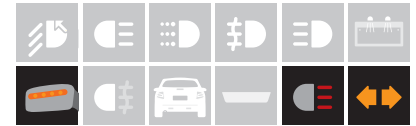

### FEATURES AND BENEFITS

- Higher drive current capability for increased flux performance
- Low thermal resistance for better hot lumen performance
- Standard packaging for low cost and ease of manufacturability
- Available in 591nm, 615nm, 630nm and 635nm colors for increased design options
- AEC-Q101D qualified

### PRIMARY APPLICATIONS

- Mirror/Side Repeater
- Stop/Tail
  - CHMSL
- Turn

# Table of Contents

<b>General Product Information</b> .....	<b>2</b>
Product Test Conditions .....	2
Part Number Nomenclature .....	2
Environmental Compliance .....	2
<b>Performance Characteristics</b> .....	<b>3</b>
Product Selection Guide .....	3
Optical Characteristics .....	3
Electrical and Thermal Characteristics .....	3
Absolute Ratings .....	4
<b>Characteristic Curves</b> .....	<b>4</b>
Spectral Power Distribution Characteristics .....	4
Light Output Characteristics .....	5
Forward Current Characteristics .....	6
Radiation Pattern Characteristics .....	7
Operating Limits Characteristics .....	7
Permissible Pulse Handling Characteristics .....	8
<b>Product Bin and Labeling Definitions</b> .....	<b>9</b>
Designing with SignalSure .....	9
Decoding Product Bin Labeling .....	9
Luminous Flux Bins .....	10
Color Codes .....	11
Forward Voltage Bins .....	11
<b>Mechanical Dimensions</b> .....	<b>12</b>
<b>Reflow Soldering Guidelines</b> .....	<b>13</b>
JEDEC Moisture Sensitivity .....	13
Solder Pad Design .....	14
<b>Packaging Information</b> .....	<b>15</b>
Pocket Tape Dimensions .....	15
Reel Dimensions .....	15
Product Labeling .....	16

# General Product Information

## Product Test Conditions

SignalSure 75 LEDs are tested and binned using a 20ms monopulse (MP) at 75mA drive current, junction temperature,  $T_j$ , of 25°C.

## Part Number Nomenclature

Part numbers for SignalSure 75 follow the convention below:

A 1 D P – **B C C C L D 7 E F G H 0 0**

Where:

- B** – designates color (A=Amber, O=Red Orange and S=Super Red)
- C C C** – designates minimum dominant wavelength (588=588nm, 612=612nm, 627=627nm and 632=632nm)
- D** – designates the binning condition (1=single binning (75mA), 8=dual binning (75mA and 5mA))
- E** – designates minimum flux bin (See Product Bin and Labeling section)
- F** – designates flux bin range (3=3 subsequent flux bins including the minimum bin)
- G H** – designates forward voltage range in which G is the minimum  $V_f$  bin and H is the maximum  $V_f$  bin (See Product Bin and Labeling Definitions section)

Therefore, the following part number is used for a SignalSure 75 Super Red, 632nm minimum wavelength, single binned at 75mA, luminous flux range of 5.1 lumens to 8.7 lumens and forward voltage range of 2.07 volts to 2.67 volts:

A 1 D P – **S 6 3 2 L 1 7 C 3 A E 0 0**

## Environmental Compliance

Lumileds LLC is committed to providing environmentally friendly products to the solid-state lighting market. SignalSure 75 is compliant to the European Union directives on the restriction of hazardous substances in electronic equipment, namely the RoHS Directive 2011/65/EU and REACH Regulation (EC) 1907/2006. Lumileds LLC will not intentionally add the following restricted materials to its products: lead, mercury, cadmium, hexavalent chromium, polybrominated biphenyls (PBB) or polybrominated diphenyl ethers (PBDE).

# Performance Characteristics

## Product Selection Guide

Table 1. Product selection for SignalSure 75 at 20ms MP, 75mA, T<sub>j</sub>=25°C.

COLOR	DOMINANT WAVELENGTH <sup>[1,2]</sup> (nm)	PART NUMBER
Amber	591	A1DP - A588L
Red Orange	615	A1DP - O612L
Super Red	630	A1DP - S627L
Super Red	635	A1DP - S632L

**Notes for Table 1:**

1. Dominant wavelength is derived from the CIE 1931 Chromaticity diagram and represents perceived color.
2. Lumileds maintains a tolerance of ±1nm for dominant wavelength measurements.

## Optical Characteristics

Table 2. Typical optical characteristics for SignalSure 75 at 20ms MP, 75mA, T<sub>j</sub>=25°C.

PART NUMBER	TYPICAL TOTAL INCLUDED ANGLE <sup>[1]</sup> $\theta_{0.90V}$	TYPICAL VIEWING ANGLE <sup>[2]</sup> $2\theta_{1/2}$
A1DP - A588L	140°	120°
A1DP - O612L	140°	120°
A1DP - S627L	140°	120°
A1DP - S632L	140°	120°

**Notes for Table 2:**

1. Total angle at which 90% of total luminous flux is captured.
2. Viewing angle is the off axis angle from the LED center line where the luminous intensity is ½ of the peak value.

## Electrical and Thermal Characteristics

Table 3. Typical electrical and thermal characteristics for SignalSure 75 at 20ms MP, 75mA, T<sub>j</sub>=25°C.

PARAMETER	PERFORMANCE
Forward Voltage, V <sub>f</sub>	2.35V
Electrical Thermal Resistance, R <sub>th j-c electr</sub> <sup>[1]</sup> (Maximum)	45°C/W
Real Thermal Resistance, R <sub>th j-c real</sub> <sup>[2]</sup> (Maximum)	60°C/W
Temperature Coefficient of V <sub>f</sub> , I <sub>f</sub> = 75mA, 10°C ≤ T <sub>c</sub> ≤ 110°C	-3.9mV/°C

**Notes for Table 3:**

1. R<sub>th j-c electr</sub>: Electrical thermal resistance (junction to case).
2. R<sub>th j-c real</sub>: Real thermal resistance (junction to case) with wall plug efficiency included. Reference JE5D51-51, JE5D51-14, 4.1.3.

# Absolute Ratings

Table 4. Absolute ratings for SignalSure 75.

PARAMETER	PERFORMANCE
Minimum DC Forward Current	5mA
Maximum DC Forward Current	90mA
Maximum Junction Temperature <sup>[1]</sup>	135°C
Operating Case Temperature at Test Current <sup>[1]</sup>	-40°C to 115°C
Operating Case Temperature at Maximum Current <sup>[1]</sup>	-40°C to 115°C
Storage Temperature	-40°C to 115°C
Soldering Temperature	JEDEC 020c 260°C
Allowable Reflow Cycles	3
Minimum ESD performance <sup>[2]</sup>	2kV HBM (Class 2), 1kV CDM (Class III)
Reverse Voltage (V <sub>r</sub> )	-10V

**Notes for Table 4:**

1. Proper current derating must be observed to maintain junction temperature below the maximum, so that the LED is maintained below the maximum rated operating case temperature. SignalSure LEDs driven at or above the maximum rated operating case temperature may have shorter lifetime.
2. Measured using human body model (per ANSI/ESDA/JEDEC JS-001-2010) and charged device model (per JESD22-C101F).

## Characteristic Curves

### Spectral Power Distribution Characteristics

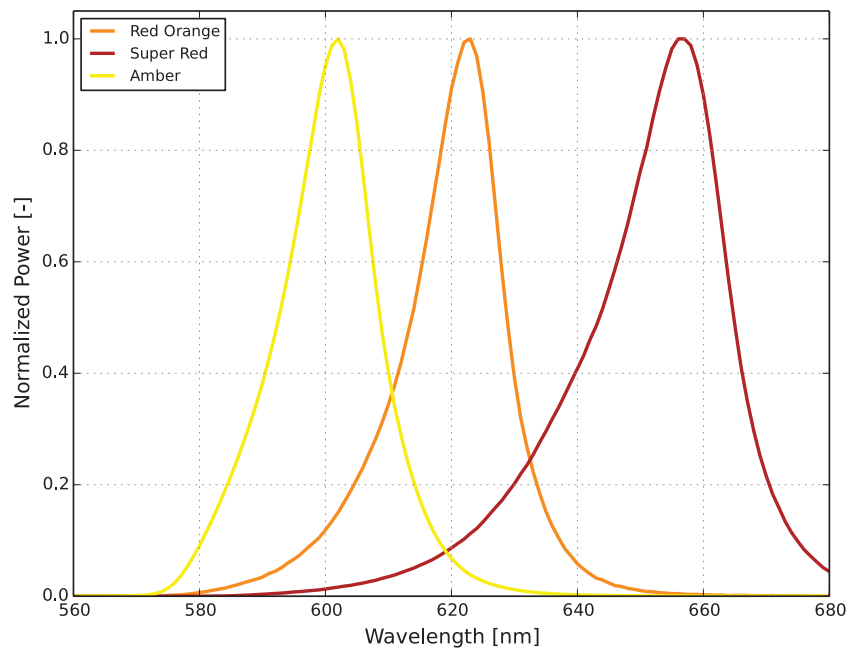

Figure 1. Typical normalized power vs. wavelength for SignalSure 75 at 20ms MP, 75mA, T<sub>j</sub>=25°C.

# Light Output Characteristics

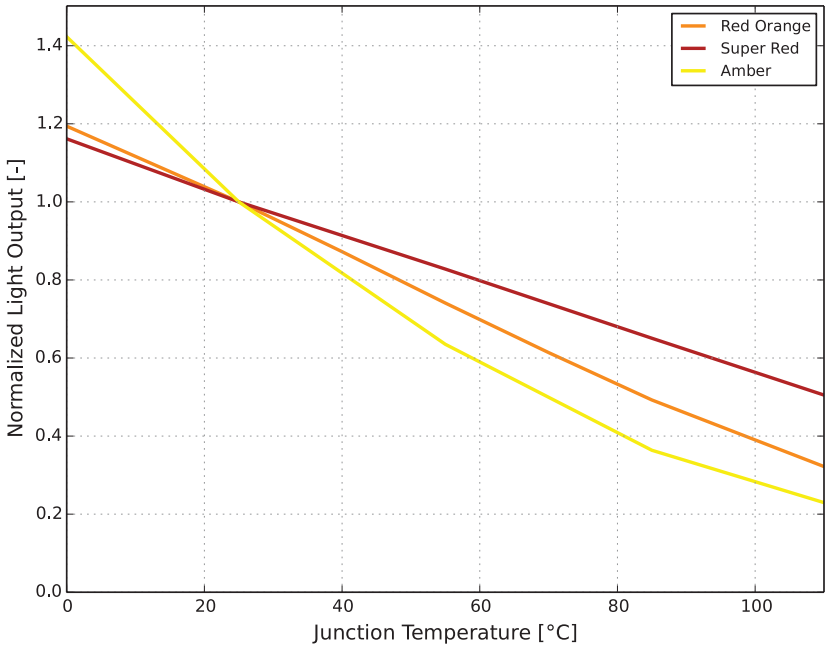

Figure 2. Typical normalized light output vs. junction temperature for SignalSure 75 at 20ms MP, 75mA.

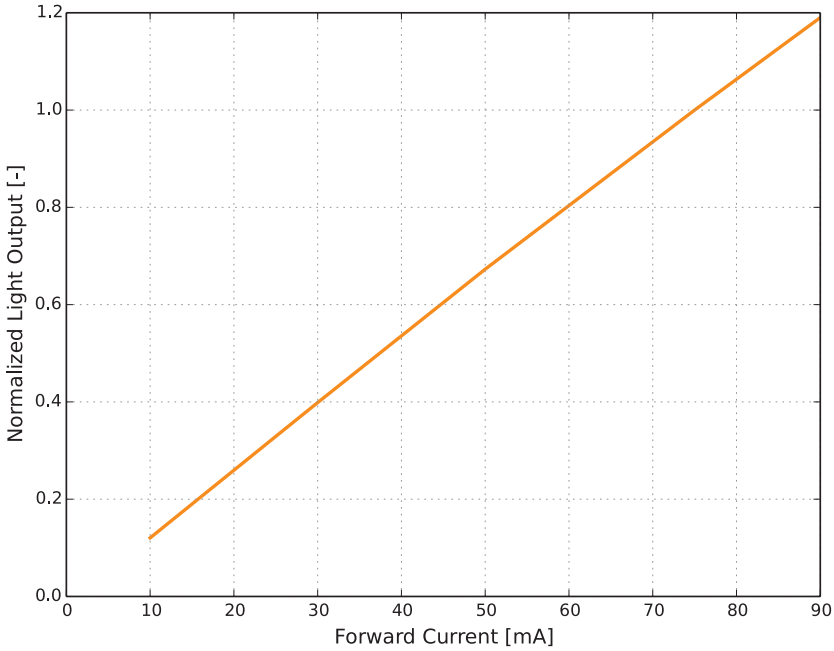

Figure 3. Typical normalized light output vs. forward current for SignalSure 75 at T<sub>j</sub>=25°C.

# Forward Current Characteristics

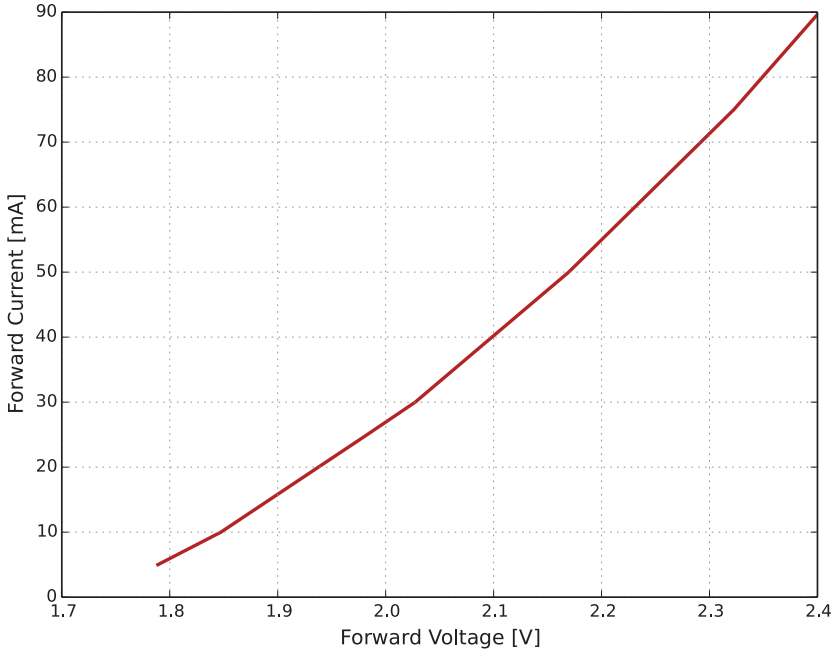

Figure 4a. Typical forward current vs. forward voltage for SignalSure 75 at  $T_j=25^{\circ}\text{C}$ .

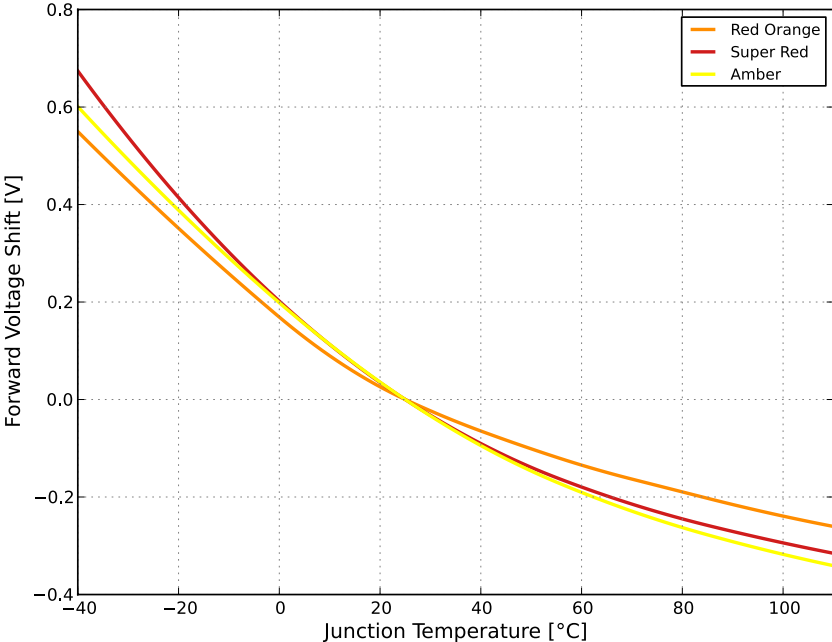

Figure 4b. Typical forward voltage shift vs. junction temperature for SignalSure 75 at 20ms MP, specified test current.

## Radiation Pattern Characteristics

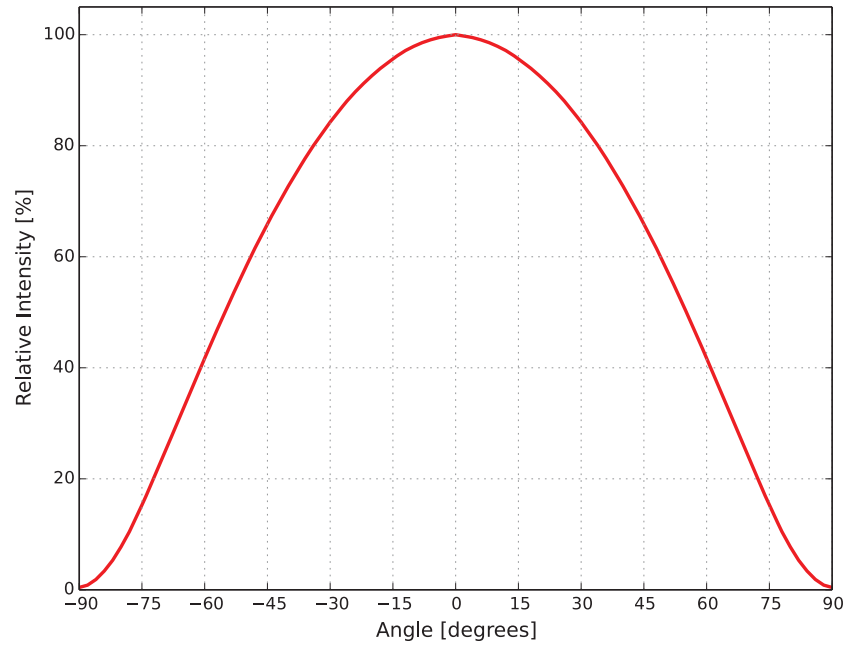

Figure 5. Typical radiation pattern for SignalSure 75 at 20ms MP, 75mA.

## Operating Limits Characteristics

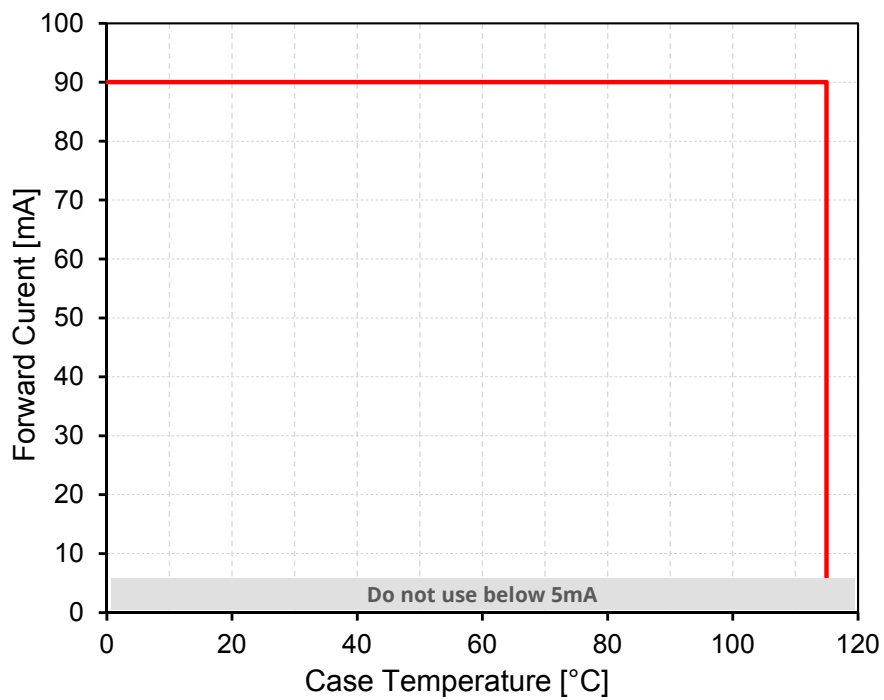

Figure 6. Maximum forward current vs. case temperature for SignalSure 75.



# Permissible Pulse Handling Characteristics

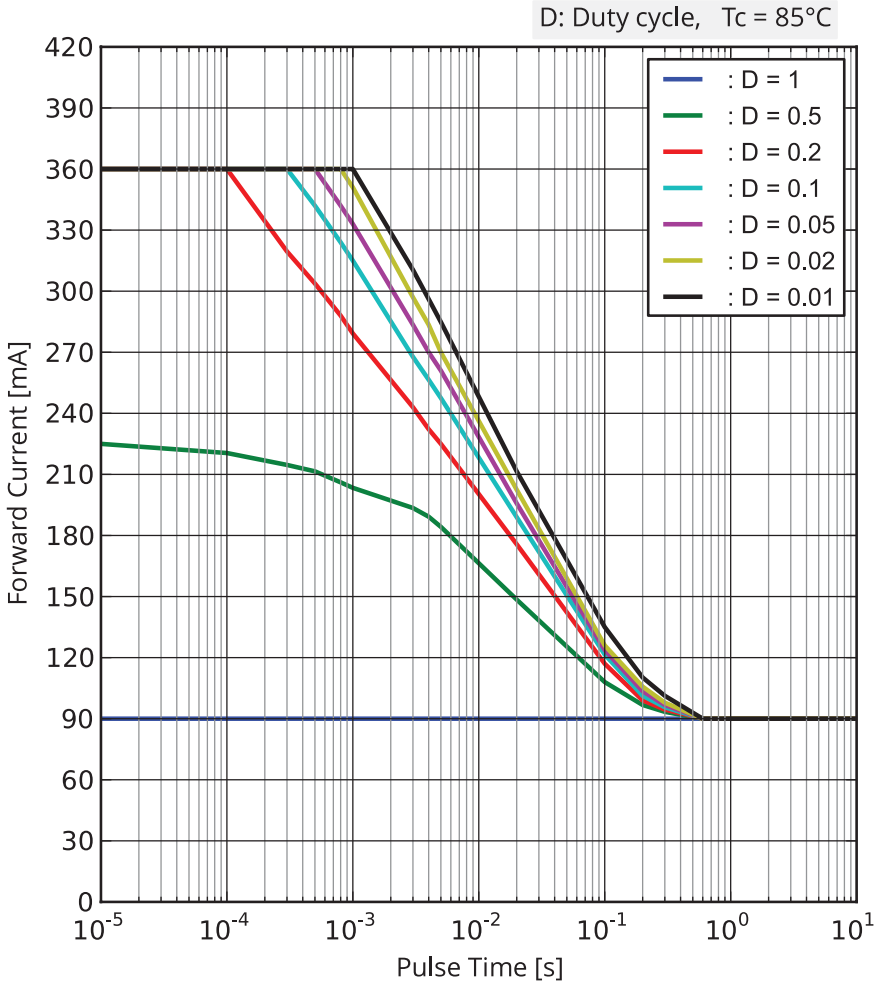

Figure 7. Permissible pulse handling capability for SignalSure 75.

# Product Bin and Labeling Definitions

## Designing with SignalSure

Flux bins supportable for car programs depend on product color and program start- and end-of-production date. Flux roadmaps by year and product color are maintained and available from the sales representative. Please contact your local sales representative to request the flux bin range with best supportability for program timing.

## Decoding Product Bin Labeling

In the manufacturing of semiconductor products, there are variations in performance around the average values given in the technical datasheets. For this reason, Lumileds bins the LED components for luminous flux, color and forward voltage.

SignalSure 75 single binned LEDs are labeled using a 3-digit alphanumeric CAT code following the format below:

### A B C

- A** – designates luminous flux bin at 75mA (example: B=4.3 lumens to 5.1 lumens)
- B** – designates color code (example: 3=612nm to 618nm)
- C** – designates forward voltage bin at 75mA (example: B=2.19V to 2.31V)

SignalSure 75 dual binned LEDs are labeled using a 5-digit CAT code following the format below:

### A b C D e

- A** – designates luminous flux bin at 75mA (example: B=4.3 lumens to 5.1 lumens)
- b** – designates luminous flux bin at 5mA (example: g=0.35 lumens to 0.42 lumens)
- C** – designates color code (example: 3=612nm to 618nm)
- D** – designates forward voltage bin at 75mA (example: B=2.19V to 2.31V)
- e** – designates forward voltage bin at 5mA (example: b=1.72V to 1.78V)

## Luminous Flux Bins

Table 5 lists the standard luminous flux bins for SignalSure 75 emitters. Product availability in a particular bin varies by color and platform start-of-production date. Contact your local sales representative for best supportability of programs.

**Table 5a. Luminous flux bin definitions for SignalSure 75 at 20ms MP, 75mA,  $T_j=25^\circ\text{C}$ .**

BIN	LUMINOUS FLUX (lm)	
	MINIMUM	MAXIMUM
B	4.3	5.1
C	5.1	6.1
D	6.1	7.3
E	7.3	8.7
F	8.7	10.4
G	10.4	12.5
H	12.5	15.0

**Notes for Table 5a:**

1. Lumileds maintains a tolerance of  $\pm 10\%$  on luminous flux measurements.

**Table 5b. Luminous flux bin definitions for SignalSure 75 at 20ms MP, 5mA,  $T_j=25^\circ\text{C}$ .**

BIN	LUMINOUS FLUX (lm)	
	MINIMUM	MAXIMUM
g	0.35	0.42
h	0.42	0.50
j	0.50	0.60
m	0.60	0.72
n	0.72	0.86
p	0.86	1.02
r	1.02	1.22
u	1.22	1.46

**Notes for Table 5b:**

1. Lumileds maintains a tolerance of  $\pm 10\%$  on luminous flux measurements.
2. Applies to dual binning option only.

**Table 5c. Luminous flux bin pairing for SignalSure 75 at 20ms MP, 75mA and 5mA,  $T_j=25^\circ\text{C}$ .**

BIN	PAIRING BIN	MINIMUM LUMINOUS FLUX (lm)	MAXIMUM LUMINOUS FLUX (lm)
75mA		5mA	
F	g, h, j, m, n, p	0.35	1.02
G	h, j, m, n, p, r	0.42	1.22
H	j, m, n, p, r, u	0.50	1.46

**Notes for Table 5c:**

1. Applies to dual binning option only.

## Color Codes

Table 6. Color code definitions for SignalSure 75 at 20ms MP, 75mA,  $T_j=25^\circ\text{C}$ .

CODE	DOMINANT WAVELENGTH (nm)	
	MINIMUM	MAXIMUM
1	588	592
2	592	595
3	612	618
4	627	632
5	632	638

**Notes for Table 6:**

1. Lumileds maintains a tolerance of  $\pm 1\text{nm}$  on dominant wavelength measurements.

## Forward Voltage Bins

Table 7a. Forward voltage bin definitions for SignalSure 75 at 20ms MP, 75mA,  $T_j=25^\circ\text{C}$ .

BIN	FORWARD VOLTAGE ( $V_f$ )	
	MINIMUM	MAXIMUM
A	2.07	2.19
B	2.19	2.31
C	2.31	2.43
D	2.43	2.55
E	2.55	2.67
F	2.67	2.79

**Notes for Table 7a:**

1. Lumileds maintains a tolerance of  $\pm 0.06\text{V}$  on forward voltage measurements.
2. Applies to dual binning option only.

Table 7b. Forward voltage bin definitions for SignalSure 75 at 20ms MP, 5mA,  $T_j=25^\circ\text{C}$ .

BIN	FORWARD VOLTAGE ( $V_f$ )	
	MINIMUM	MAXIMUM
a	1.66	1.72
b	1.72	1.78
c	1.78	1.84
d	1.84	1.90
e	1.90	1.96
f	1.96	2.02
g	2.02	2.08
h	2.08	2.14
j	2.14	2.20

**Notes for Table 7b:**

1. Lumileds maintains a tolerance of  $\pm 0.06\text{V}$  on forward voltage measurements.
2. Applies to dual binning option only.

Table 7c. Forward voltage bin pairing for SignalSure 75 at 20ms MP, 75mA and 5mA,  $T_j=25^{\circ}\text{C}$ .

BIN	MINIMUM FORWARD VOLTAGE ( $V_f$ )	MAXIMUM FORWARD VOLTAGE ( $V_f$ )	PAIRING BIN	MINIMUM FORWARD VOLTAGE ( $V_f$ )	MAXIMUM FORWARD VOLTAGE ( $V_f$ )
75mA			5mA		
A	2.07	2.19	a, b, c, d	1.66	1.90
B	2.19	2.31	a, b, c, d, e	1.66	1.96
C	2.31	2.43	a, b, c, d, e, f	1.66	2.02
D	2.43	2.55	a, b, c, d, e, f, g	1.66	2.08
E	2.55	2.67	b, c, d, e, f, g, h	1.72	2.14
F	2.67	2.79	c, d, e, f, g, h, j	1.78	2.20

Notes for Table 7c:

1. Lumileds maintains a tolerance of  $\pm 0.06\text{V}$  on forward voltage measurements.
2. Applies to dual binning option only.

## Mechanical Dimensions

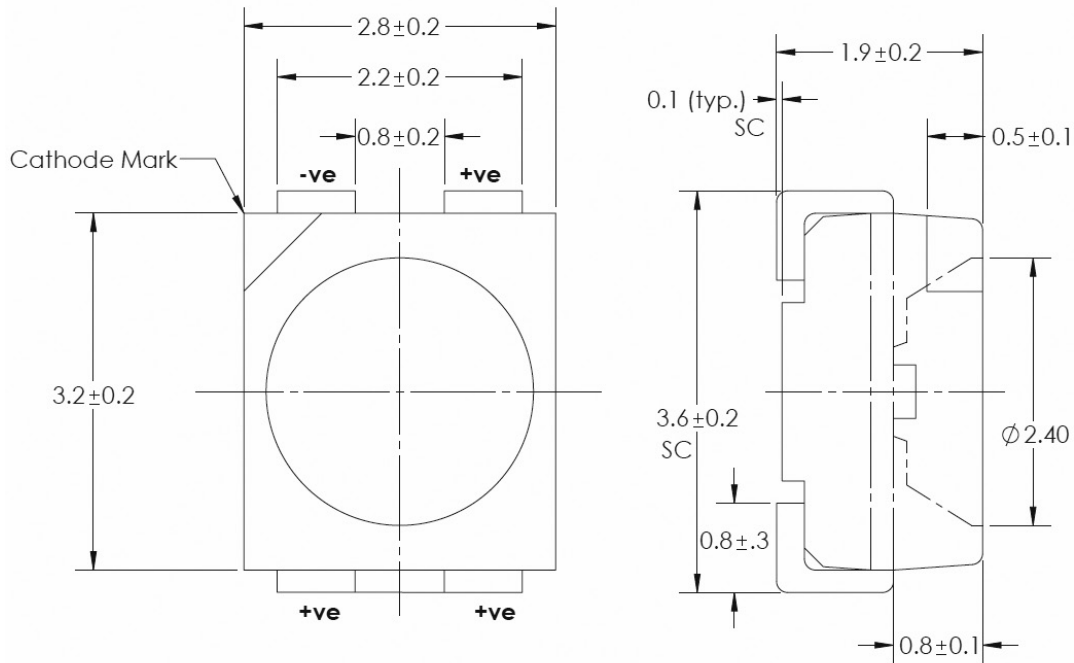

\* Note: SC = Special Characteristics  
 General Tolerances:  $\pm 0.10$   
 Dimensions are in mm.

Figure 8. Mechanical dimensions for SignalSure 75.

Notes for Figure 8:

1. Drawings are not to scale.
2. All dimensions are in millimeters.

# Reflow Soldering Guidelines

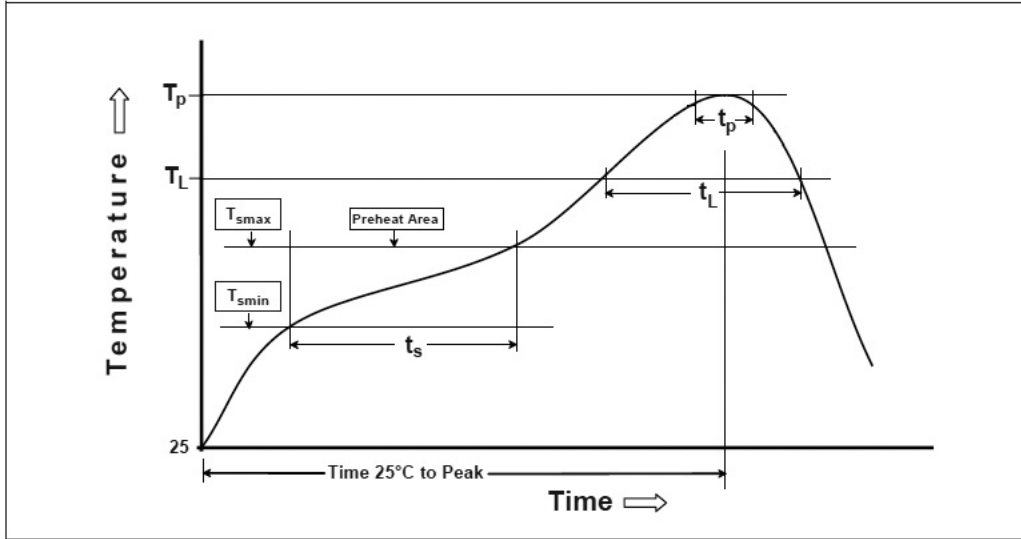

Figure 9. Visualization of the acceptable reflow temperature profile as specified in Table 8.

Table 8. Reflow profile characteristics for SignalSure 75.

PROFILE FEATURE	LEAD FREE ASSEMBLY
Preheat Minimum Temperature ( $T_{smin}$ )	150°C
Preheat Maximum Temperature ( $T_{smax}$ )	200°C
Preheat Time ( $t_{smin}$ to $t_{smax}$ )	60 to 180 seconds
Ramp-Up Rate ( $T_L$ to $T_p$ )	3°C / second maximum
Liquidus Temperature ( $T_L$ )	217°C
Time Maintained Above Temperature $T_L$ ( $t_L$ )	60 to 150 seconds
Peak / Classification Temperature ( $T_p$ )	260°C
Time Within 5°C of Actual Temperature ( $t_p$ )	20 to 40 seconds
Ramp-Down Rate ( $T_p$ to $T_L$ )	6°C / second maximum
Time 25°C to Peak Temperature	8 minutes maximum

**Notes for Table 8:**

1. All temperatures refer to the application Printed Circuit Board (PCB), measured on the surface adjacent to the package body.

## JEDEC Moisture Sensitivity

Table 9. Moisture sensitivity levels for SignalSure 75.

LEVEL	FLOOR LIFE <sup>(1)</sup>		SOAK REQUIREMENTS STANDARD	
	TIME	CONDITIONS	TIME	CONDITIONS
2	1 Year	≤30°C / 60% RH	168 Hours +5 / -0	85°C / 60% RH

**Notes for Table 9:**

1. Shelf life 2 years.

# Solder Pad Design

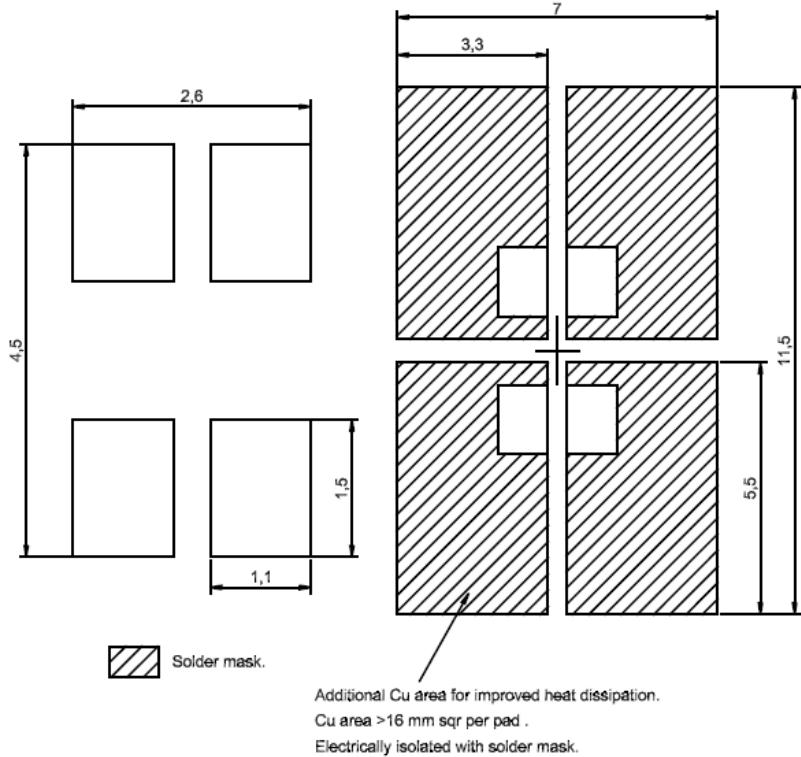

Figure 10. Recommended PCB solder pad layout for SignalSure 75.

- Notes for Figure 10:
1. The drawing shows the recommended SignalSure 75 layout on Printed Circuit Board (PCB).
  2. All dimensions are in millimeters.

# Packaging Information

## Pocket Tape Dimensions

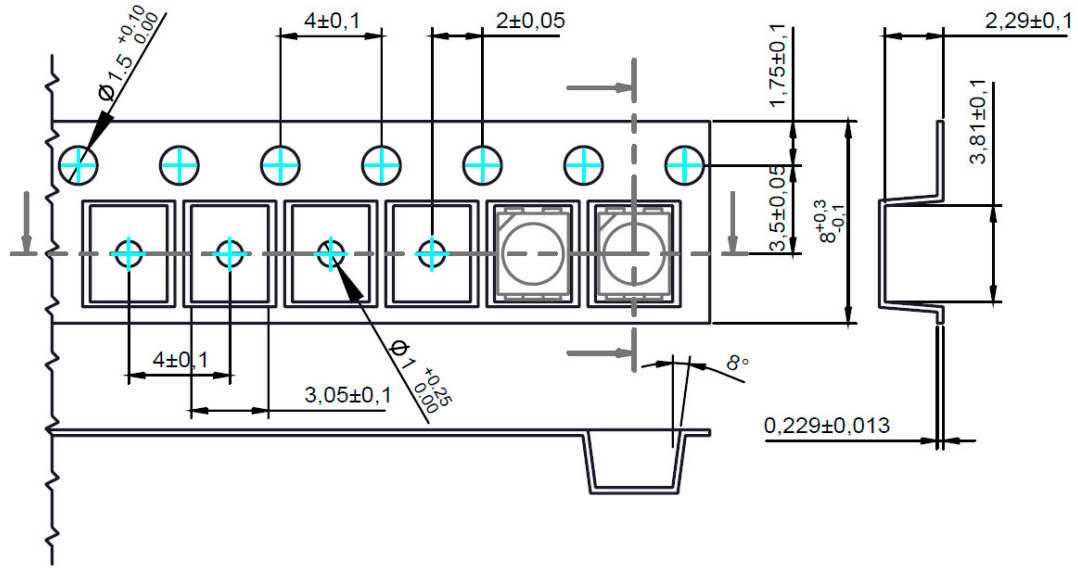

Figure 11. Pocket tape dimensions for SignalSure 75.

## Reel Dimensions

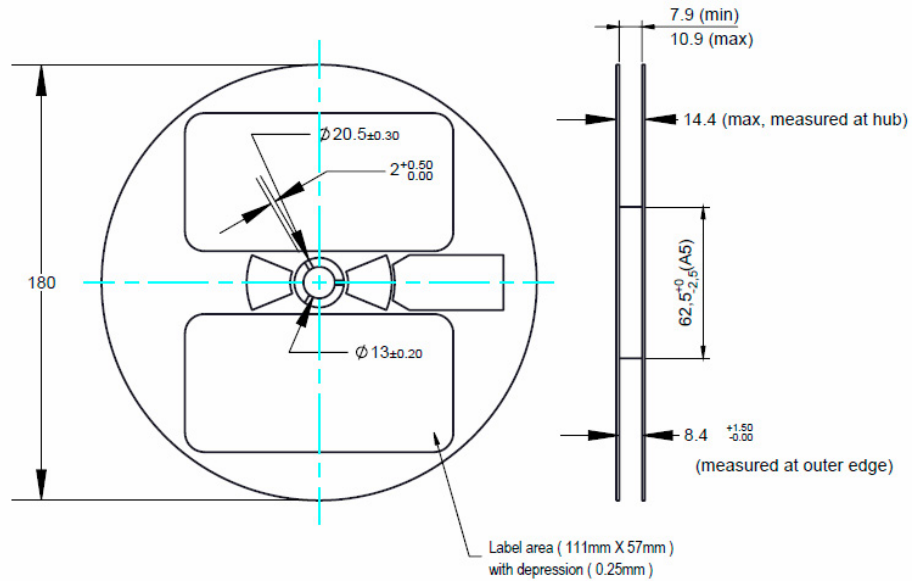

Figure 12. Reel dimensions for SignalSure 75.

Notes for Figures 11 and 12:

1. Drawings are not to scale.
2. All dimensions are in millimeters.



# Product Labeling

SignalSure 75 LEDs are packaged in moisture barrier bags on reels. Both moisture barrier bag and reels have printed information providing part numbers with CAT codes that indicate luminous flux bin, color bins and forward voltage bins.







(1P) PART #: **A1DL-0612L12U3AF00**   
  
(30P) PART OPT#: **A1DL-0612L12U3AF00U3A** RoHS Compliant  
  
(Q) QTY : **2000** LOT NO : EE150042.01 S/N : 462  
  
(9D) DTE : **1514** LUMILEDS P/N :  
  
(P) CUST PROD ID : **A1DL-0612L12U3AF00**  
  
(K) PO NO : **CAT : U3A**  
  
**BIN :**  
**APR**

---

BUNDLE ID **150401282202** MADE IN : MALAYSIA **CAT : U3A**  
  
MFG DATE : 1514  
TAP DATE : 1514  
QA DATE : 20150414  
FGI POOL :

 U3A 

Figure 13. Example of a moisture barrier bag label.

(1P) PART # : **A1DL-0612L12U3AF00**   
  
(30P) PART OPT # : **A1DL-0612L12U3AF00U3A** RoHS Compliant  
  
(Q) QUANTITY : **2000** LUMILEDS P/N :  
  
(9D) DTE : **1514** **A1DL-0612L12U3AF00**  
  
(P) CUST PROD ID : LOT NO : EE150042.01  
  
S/N : 471 **CAT : U3A**  
**BIN :**  
**APR**

---

**150401282211** MADE IN : MALAYSIA **CAT : U3A**  
  
DEPT ID : P04  
MFG DATE : 1514  
TAP DATE : 1514  
QA DATE : 20150414  
FGI POOL :

 U3A

Figure 14. Example of a product reel label.

## About Lumileds

Lumileds is the global leader in light engine technology. The company develops, manufactures and distributes groundbreaking LEDs and automotive lighting products that shatter the status quo and help customers gain and maintain a competitive edge.

With a rich history of industry “firsts,” Lumileds is uniquely positioned to deliver lighting advancements well into the future by maintaining an unwavering focus on quality, innovation and reliability.

To learn more about our portfolio of light engines, visit [lumileds.com](http://lumileds.com).



©2016 Lumileds Holding B.V. All rights reserved.  
LUXEON is a registered trademark of the Lumileds Holding B.V.  
in the United States and other countries.

[lumileds.com](http://lumileds.com)

Neither Lumileds Holding B.V. nor its affiliates shall be liable for any kind of loss of data or any other damages, direct, indirect or consequential, resulting from the use of the provided information and data. Although Lumileds Holding B.V. and/or its affiliates have attempted to provide the most accurate information and data, the materials and services information and data are provided “as is,” and neither Lumileds Holding B.V. nor its affiliates warrants or guarantees the contents and correctness of the provided information and data. Lumileds Holding B.V. and its affiliates reserve the right to make changes without notice. You as user agree to this disclaimer and user agreement with the download or use of the provided materials, information and data.

## X-ON Electronics

Largest Supplier of Electrical and Electronic Components

*Click to view similar products for [High Power LEDs - Single Colour](#) category:*

*Click to view products by [Lumileds](#) manufacturer:*

Other Similar products are found below :

[GA CSSPM1.23-KTLP-W3-0-350-R18](#) [L135-L567003500000](#) [L1CU-VLT1000000000](#) [L1C1-VLT1000000000](#) [KY DDLM31.FY-8H7J-5F5G-W4A4-140-R18](#) [KY DDLM31.23-8F5H-36-C4U4-140-R18](#) [LS G6SP.01-7C8D-68-G3R3](#) [KR DDLM31.23-5G7H-25-C4U4-140-R18](#) [KT DDLM31.13-6H7J-36-W4A4-140-R18](#) [KS DDLM31.23-8E6G-68-C4U4-140-R18](#) [KB DDLM31.13-6D7E-25-24A4-140-R18](#) [GT CS8PM1.13-LSLU-26-1-350-B-R18](#) [L128-PCB1003500000](#) [GH CS8PM1.24-4T2U-1-0-350-R33](#) [GT CSHPM1.13-LSLU-26-1-350-B-R18](#) [XPEBRY-L1-0000-00S02](#) [XQEBLU-00-0000-000000Z02](#) [SPHWH2L3D30ED4V0H3](#) [XQEBLU-00-0000-000000202](#) [LUWCQ7P-LPLR-5E8G-1-K](#) [LTPL-C034UVH410](#) [XPEBBL-L1-R250-00302](#) [XPEROY-L1-0000-00B02](#) [GD CSSPM1.14-UOVJ-W4-1](#) [LST1-01F06-GRN1-00](#) [KY DMLQ31.23-HYKX-46-J3T3](#) [GD CS8PM1.14-UOVJ-W4-1](#) [XQEEPR-00-0000-000000A01-SB01](#) [LST1-01G01-UV02-00](#) [LST1-01F06-RYL1-00](#) [LST1-01F06-FRD1-00](#) [LST1-01G01-UV01-00](#) [LST1-01G01-PRD1-00](#) [XQEROY-00-0000-000000Q01-SB01](#) [LST1-01G01-UV03-00](#) [LST1-01G01-RYL1-00](#) [L135-A589003500000](#) [L135-L567L00000000](#) [L1C1-GRN1000000000](#) [LA G6SP-DAFA-24-1](#) [LS G6SP-CADB-1-1-Z](#) [LY H9PP-HZJZ-46-1](#) [SMTL6-RC](#) [MLEBLU-A1-0000-000U01](#) [MLEBLU-A1-0000-000U05](#) [MLEGRN-A1-0000-000101](#) [MLEGRN-A1-0000-000X02](#) [MLESRD-A1-0000-000W01](#) [XBDAMB-00-0000-000000701](#) [XBDAMB-00-0000-000000801](#)