

LUXEON CoB Core Range PW Gen 6

Engineered for vibrant colors

LUXEON CoB Core Range PW was built for applications that need the highest quality of light combined with market leading performances. Its beautiful color transforms areas into vibrant spaces. Above all, LUXEON CoB Core Range PW has a robust, long life span and fits easily into luminaire designs.



FEATURES AND BENEFITS

- High efficacy and superior color quality at lower energy consumption
- Various LES sizes and flux output that fit different applications and requirements
- Best in class thermal resistance enabling the use of smaller heatsinks and prolonged product life span
- Supported by a comprehensive optical, mechanical, and electrical ecosystem

PRIMARY APPLICATIONS

- Spotlights
- Track Lights
- Downlights
- Low Bay

Table of Contents

- General Product Information 2**
 - Product Test Conditions 2
 - Part Number Nomenclature 2
 - Lumen Maintenance 2
 - Environmental Compliance 2
- Performance Characteristics 3**
 - Product Selection Guide 3
 - Optical Characteristics 3
 - Electrical and Thermal Characteristics 4
- Absolute Maximum Ratings 4**
- Characteristic Curves 5**
 - Spectral Power Distribution Characteristics 5
 - Light Output Characteristics 5
 - Forward Current Characteristics 9
 - Radiation Pattern Characteristics 13
- Color Bin Definitions 14**
- Mechanical Dimensions 15**
- Packaging and Labeling Information 17**
 - Tube 17
 - Inner Box 19
 - Outer Box 21

General Product Information

Product Test Conditions

LUXEON CoB Core Range PW LEDs are tested and binned with a DC drive current specified below at a junction temperature, T_j , of 85°C:

200mA	-	L2C5-AABB1202I06PG
200mA	-	L2C5-AABB1202I09PG
300mA	-	L2C5-AABB1203I09PG
400mA	-	L2C5-AABB1204I09PG
600mA	-	L2C5-AABB1205I13PG
900mA	-	L2C5-AABB1208I15PG
900mA	-	L2C5-AABB1210I15PG

Part Number Nomenclature

Part numbers for LUXEON CoB Core Range PW follow the convention below:

L 2 C 5 – A A B B C C C C D E E F G

Where:

- A A** – designates nominal CCT (30=3000K, 35=3500K, 40=4000K)
- B B** – designates minimum CRI (80=80CRI, 90=90CRI)
- C C C C** – designates product configuration (example: 1205, 1208, 1210)
- D** – designates options for product specification
- E E** – designates light emitting surface (LES) size (06=6mm, 09=9mm, 13=13mm, 15=15mm)
- F** – designates options for product specification
- G** – designates SDCM (2=2-step MacAdam, 0=3-step MacAdam)

Therefore, the following part number is used for a LUXEON Core Range CoB PW 1208, Gen 6, 3000K 90CRI, 2 SDCM, with a 15mm LES:

L 2 C 5 – 3 0 9 0 1 2 0 8 I 1 5 P 2

Lumen Maintenance

Please contact your local Sales Representative or Lumileds Technical Solutions Manager for more information about the long-term performance of this product.

Environmental Compliance

Lumileds LLC is committed to providing environmentally friendly products to the solid-state lighting market. LUXEON CoB Core Range PW is compliant to the European Union directives on the restriction of hazardous substances in electronic equipment, namely the RoHS Directive 2011/65/EU and REACH Regulation (EC) 1907/2006. Lumileds LLC will not intentionally add the following restricted materials to its products: lead, mercury, cadmium, hexavalent chromium, polybrominated biphenyls (PBB) or polybrominated diphenyl ethers (PBDE).

Performance Characteristics

Product Selection Guide

Table 1. Product performance of LUXEON CoB Core Range PW at specified test current, $T_j=85^\circ\text{C}$.

LES ^[1] (mm)	NOMINAL CCT	MINIMUM CRI ^[2, 3, 4]	LUMINOUS FLUX ^[2] (lm)		TYPICAL LUMINOUS EFFICACY (lm/W)	TEST CURRENT (mA)	ENERGY EFFICIENCY CLASS ^[5]	PART NUMBER ^[6]
			MINIMUM	TYPICAL				
6	3000K	90	961	1068	158	200	D	L2C5-30901202I06Px
6	3500K	90	971	1078	159	200	D	L2C5-35901202I06Px
6	4000K	90	978	1086	160	200	D	L2C5-40901202I06Px
9	3000K	90	985	1095	161	200	D	L2C5-30901202I09Px
9	3500K	90	997	1108	163	200	D	L2C5-35901202I09Px
9	4000K	90	1007	1118	165	200	D	L2C5-40901202I09Px
9	3000K	90	1453	1614	159	300	D	L2C5-30901203I09Px
9	3500K	90	1458	1620	159	300	D	L2C5-35901203I09Px
9	4000K	90	1459	1622	159	300	D	L2C5-40901203I09Px
9	3000K	90	1894	2104	155	400	D	L2C5-30901204I09Px
9	3500K	90	1917	2130	157	400	D	L2C5-35901204I09Px
9	4000K	90	1935	2150	159	400	D	L2C5-40901204I09Px
13	3000K	90	2863	3182	154	600	D	L2C5-30901205I13Px
13	3500K	90	2916	3240	157	600	D	L2C5-35901205I13Px
13	4000K	90	2967	3296	159	600	D	L2C5-40901205I13Px
15	3000K	90	4325	4805	156	900	D	L2C5-30901208I15Px
15	3500K	90	4344	4826	157	900	D	L2C5-35901208I15Px
15	4000K	90	4508	5009	163	900	D	L2C5-40901208I15Px
15	3000K	90	4369	4854	161	900	D	L2C5-30901210I15Px
15	3500K	90	4460	4955	164	900	D	L2C5-35901210I15Px
15	4000K	90	4500	5000	165	900	D	L2C5-40901210I15Px

Notes for Table 1:

1. Light Emitting Surface (LES) is the inner diameter (phosphor area) inside the dam.
2. Lumileds maintains a tolerance of ± 2 on CRI and $\pm 6.5\%$ on luminous flux measurements.
3. Typical CRI is approximately 2 points higher than the minimum CRI specified, but this is not guaranteed.
4. R9 value of 90CRI products is >50 .
5. Energy efficiency class as specified in Commission Delegated Regulation (EU) 2019/2015. The available range of energy efficiency classes is A-G.
6. "x" designates SDCM, 2=2-SDCM, 0=3SDCM.

Optical Characteristics

Table 2. Optical characteristics for LUXEON CoB Core Range PW at specified test current, $T_j=85^\circ\text{C}$.

PART NUMBER	TYPICAL TOTAL INCLUDED ANGLE ^[1]	TYPICAL VIEWING ANGLE ^[2]
L2C5-xxxx12xxxxPx	135°	115°

Notes for Table 2:

1. Total angle at which 90% of total luminous flux is captured.
2. Viewing angle is the off axis angle from the LED centerline where the luminous intensity is $\frac{1}{2}$ of the peak value.

Electrical and Thermal Characteristics

Table 3. Electrical and thermal characteristics for LUXEON CoB Core Range PW at specified test current, $T_j=85^\circ\text{C}$.

PART NUMBER	FORWARD VOLTAGE ^[1] (V_f)			TYPICAL TEMPERATURE COEFFICIENT OF FORWARD VOLTAGE ^[2] (mV/ $^\circ\text{C}$)	TYPICAL THERMAL RESISTANCE—JUNCTION TO CASE ^[3] ($^\circ\text{C}/\text{W}$)
	MINIMUM	TYPICAL	MAXIMUM		
L2C5-xxxx1202I06Px	31.2	33.9	36.6	-16	0.78
L2C5-xxxx1202I09Px	31.2	33.9	36.6	-16	0.78
L2C5-xxxx1203I09Px	31.2	33.9	36.6	-16	0.60
L2C5-xxxx1204I09Px	31.2	33.9	36.6	-16	0.43
L2C5-xxxx1205I13Px	31.7	34.5	37.3	-16	0.26
L2C5-xxxx1208I15Px	31.5	34.2	36.9	-16	0.20
L2C5-xxxx1210I15Px	30.9	33.6	36.3	-16	0.18

Notes for Table 3:

- Lumileds maintains a tolerance of $\pm 0.06\text{V}$ on forward voltage measurements.
- Measured between 25°C and 85°C .
- Thermal resistance is measured between junction and the bottom of the LUXEON CoB substrate.

Absolute Maximum Ratings

Table 4. Absolute maximum ratings for LUXEON CoB Core Range PW.

PARAMETER	MAXIMUM PERFORMANCE
DC Forward Current ^[1,2]	2x test current
LED Junction Temperature ^[1] (DC & Pulse)	125°C
ESD Sensitivity (ANSI/ESDA/JEDEC JS-001-2012)	Class 3B
Operating Case Temperature ^[1]	-40°C to 105°C
LED Storage Temperature	-40°C to 120°C
Reverse Voltage (V_{reverse})	LUXEON LEDs are not designed to be driven in reverse bias

Notes for Table 4:

- Proper current derating must be observed to maintain the junction temperature below the maximum allowable junction temperature.
- Residual periodic variations due to power conversion from alternating current (AC) to direct current (DC), also called "ripple," are acceptable if the following conditions are met:
 - The frequency of the ripple current is 100Hz or higher
 - The average current for each cycle does not exceed the maximum allowable DC forward current
 - The maximum amplitude of the ripple does not exceed 20% of the maximum allowable DC forward current.

Characteristic Curves

Spectral Power Distribution Characteristics

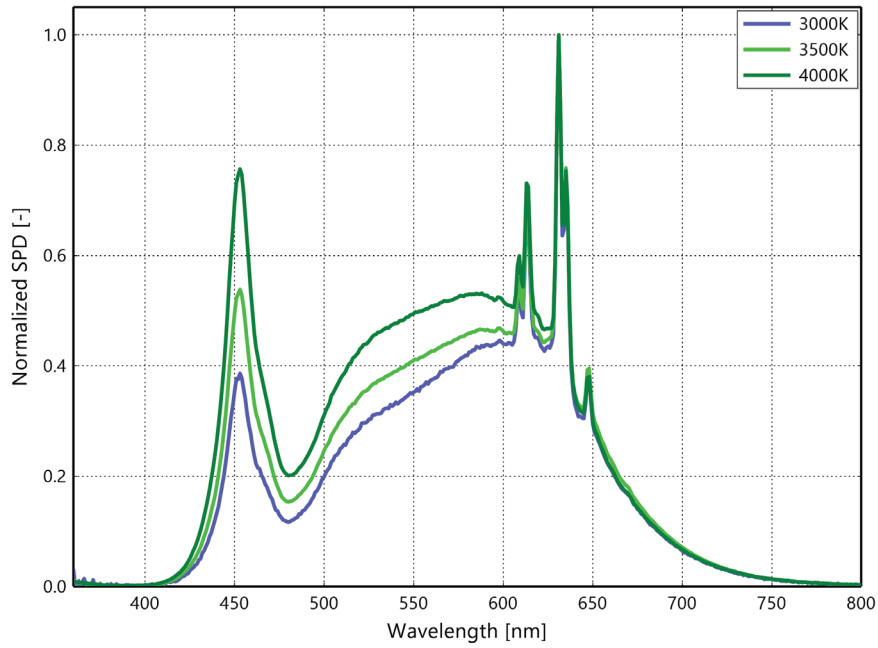

Figure 1. Typical normalized power vs. wavelength for L2C5-xx90xxxxlxxPx at specified test current, $T_j=85^{\circ}\text{C}$.

Light Output Characteristics

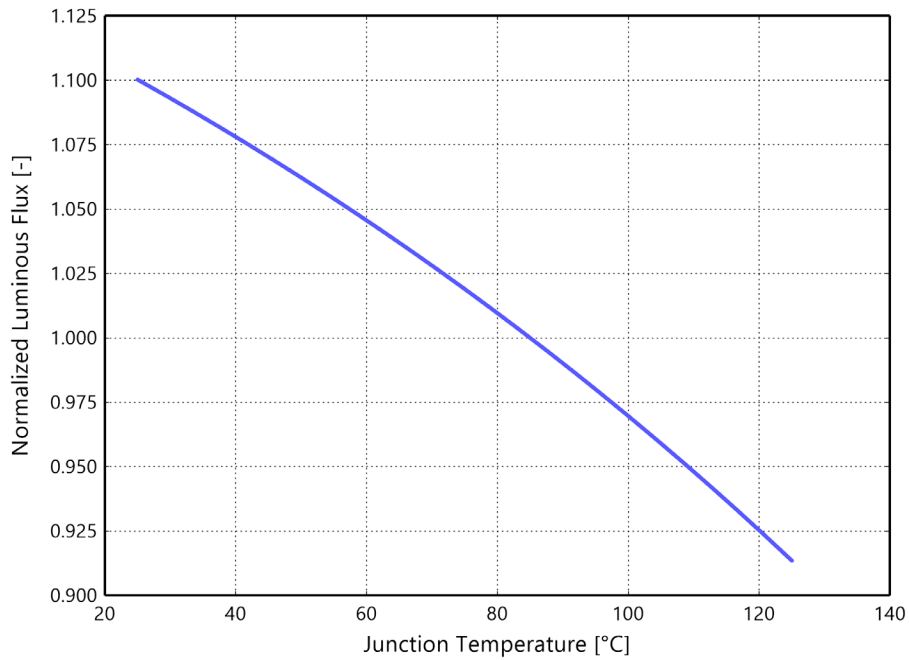

Figure 2. Typical normalized light output vs. junction temperature for L2C5-xxxx12xxxxP0 at specified test current.

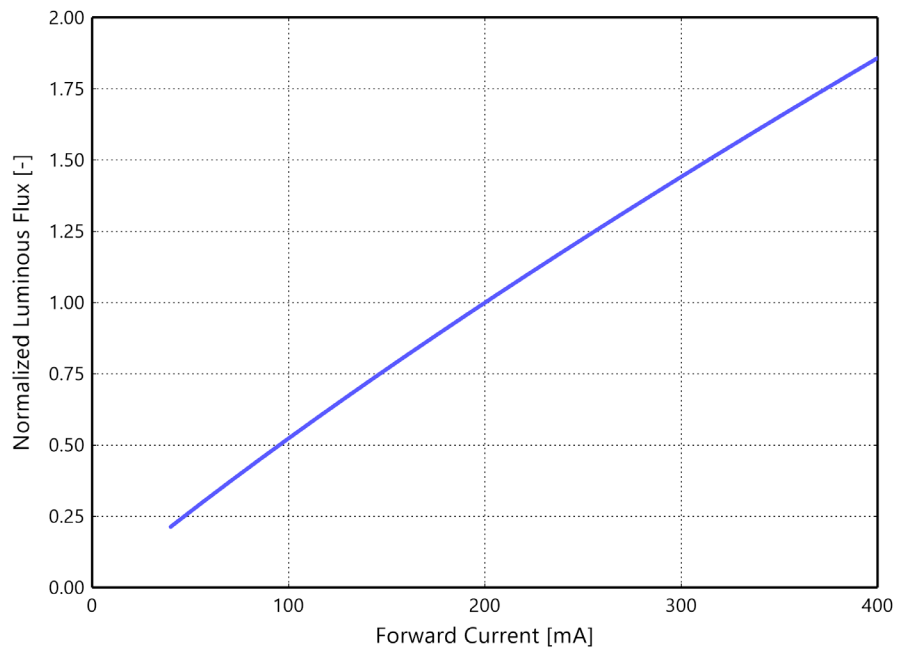

Figure 3a. Typical normalized light output vs. forward current for L2C5-xxxx1202106Px at $T_j=85^\circ\text{C}$.

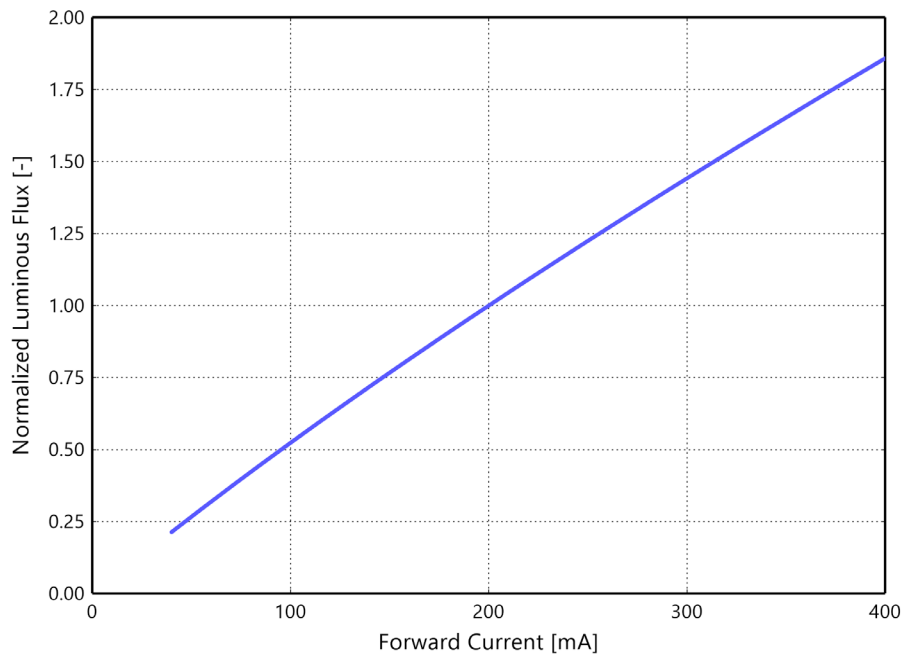

Figure 3b. Typical normalized light output vs. forward current for L2C5-xxxx1202109Px at $T_j=85^\circ\text{C}$.

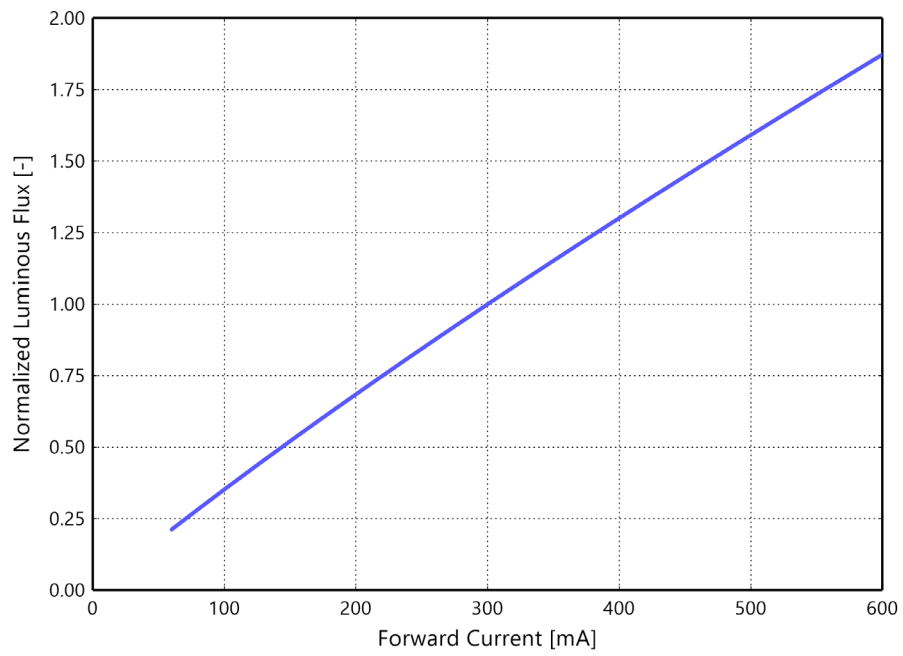

Figure 3c. Typical normalized light output vs. forward current for L2C5-xxxx1203I09Px at $T_j=85^\circ\text{C}$.

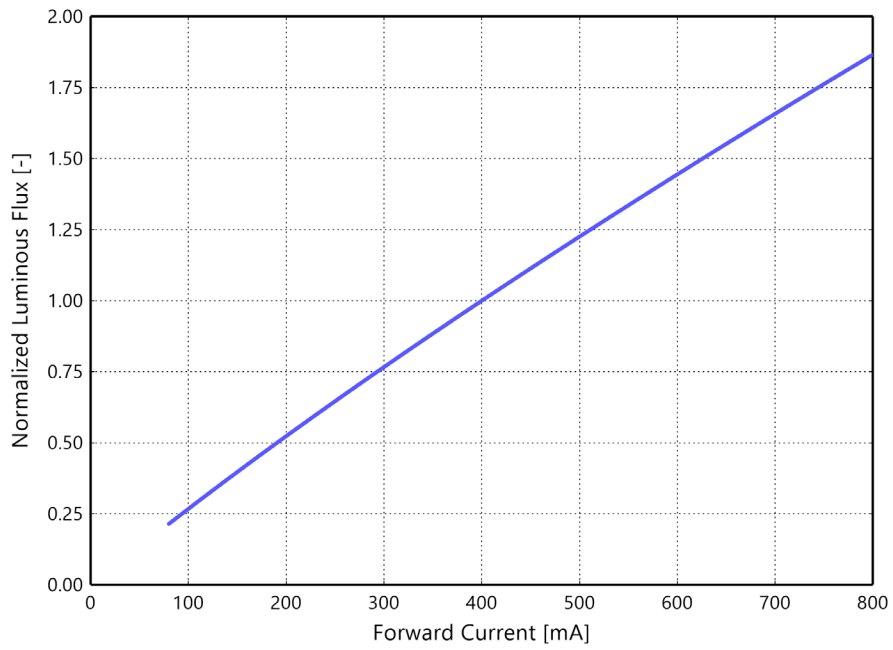

Figure 3d. Typical normalized light output vs. forward current for L2C5-xxxx1204I09Px at $T_j=85^\circ\text{C}$.

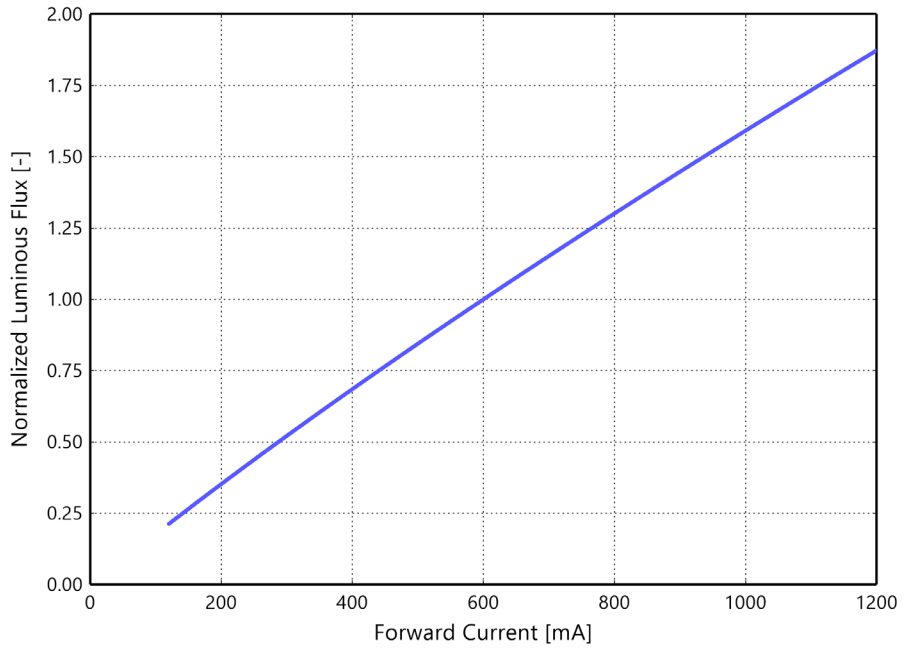

Figure 3e. Typical normalized light output vs. forward current for L2C5-xxxx1205I13Px at $T_j=85^\circ\text{C}$.

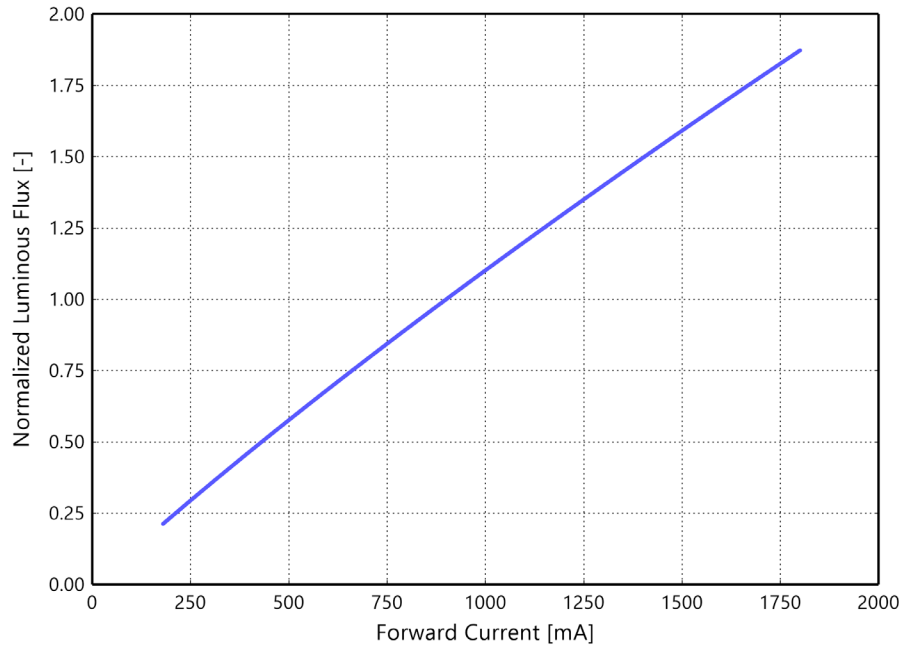

Figure 3f. Typical normalized light output vs. forward current for L2C5-xxxx1208I15Px at $T_j=85^\circ\text{C}$.

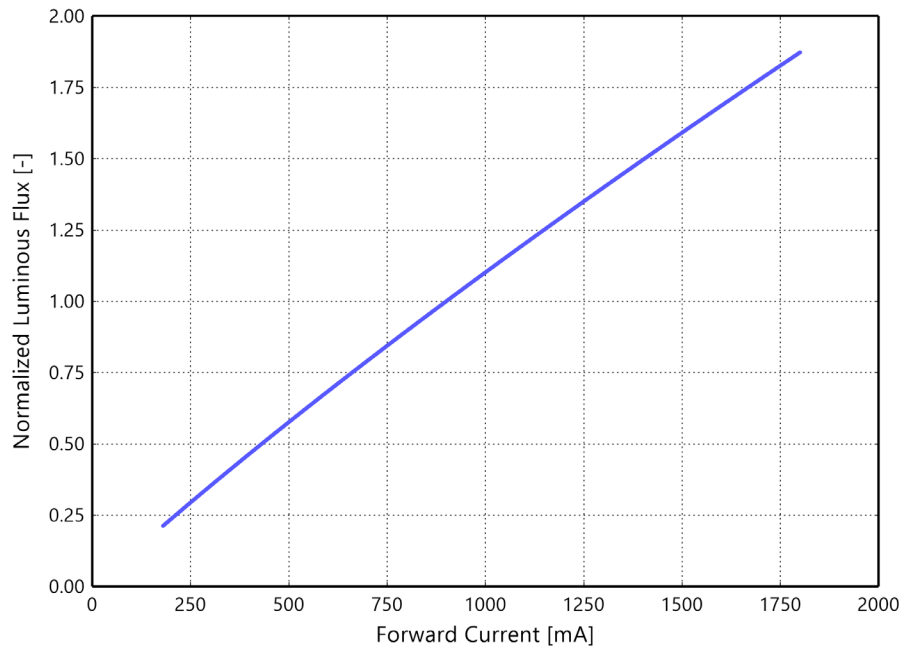

Figure 3g. Typical normalized light output vs. forward current for L2C5-xxxx1210I15Px at $T_j=85^\circ\text{C}$.

Forward Current Characteristics

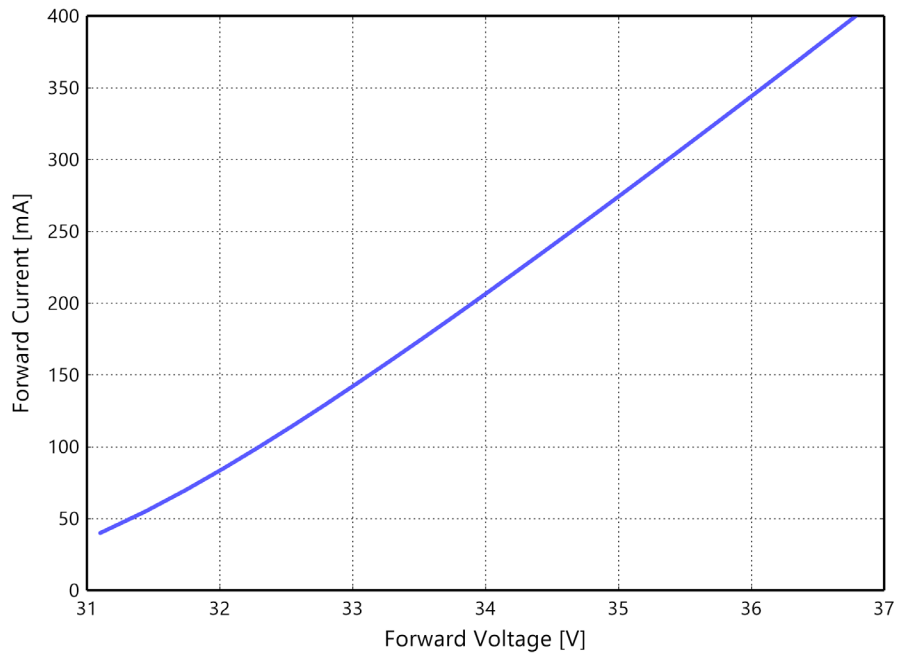

Figure 4a. Typical forward current vs. forward voltage for L2C5-xxxx1202I06Px at $T_j=85^\circ\text{C}$.

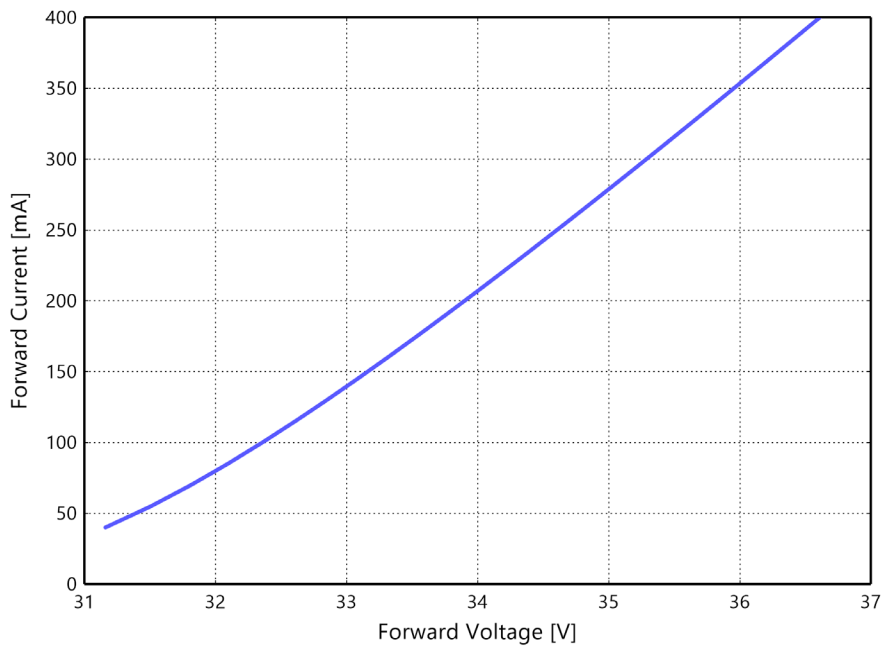

Figure 4b. Typical forward current vs. forward voltage for L2C5-xxxx1202I09Px at $T_j=85^\circ\text{C}$.

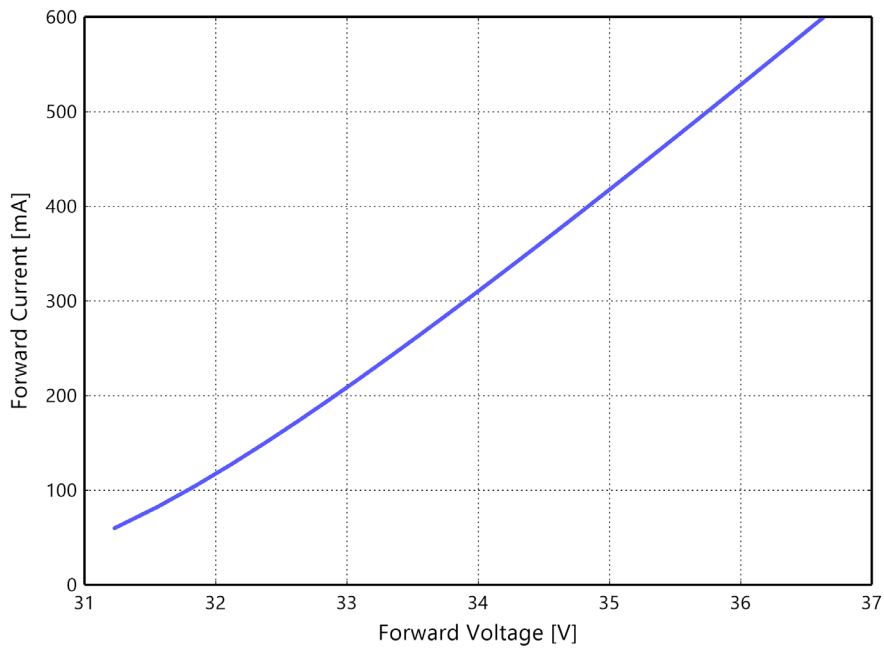

Figure 4c. Typical forward current vs. forward voltage for L2C5-xxxx1203I09Px at $T_j=85^\circ\text{C}$.

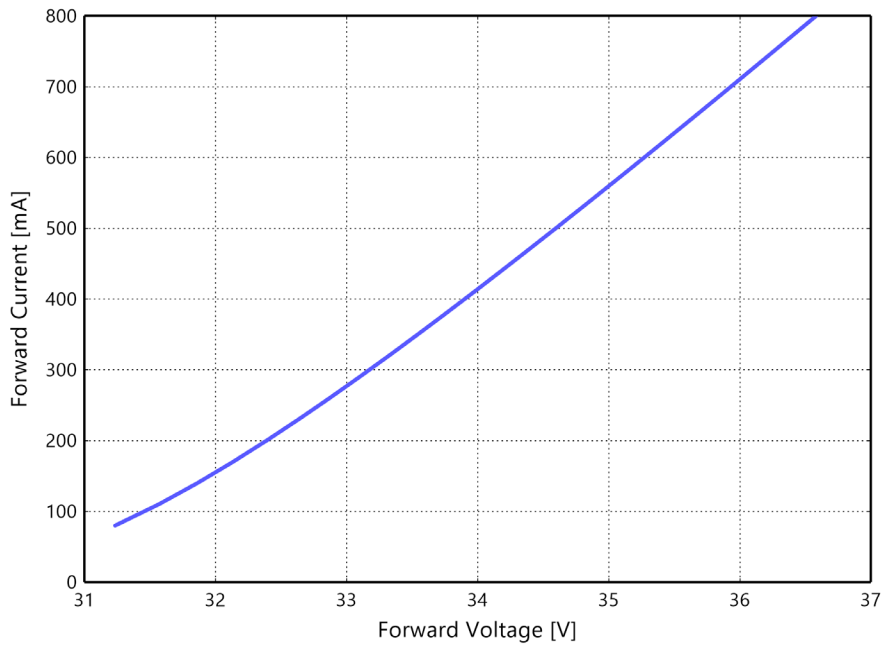

Figure 4d. Typical forward current vs. forward voltage for L2C5-xxxx1204I09Px at $T_j=85^\circ\text{C}$.

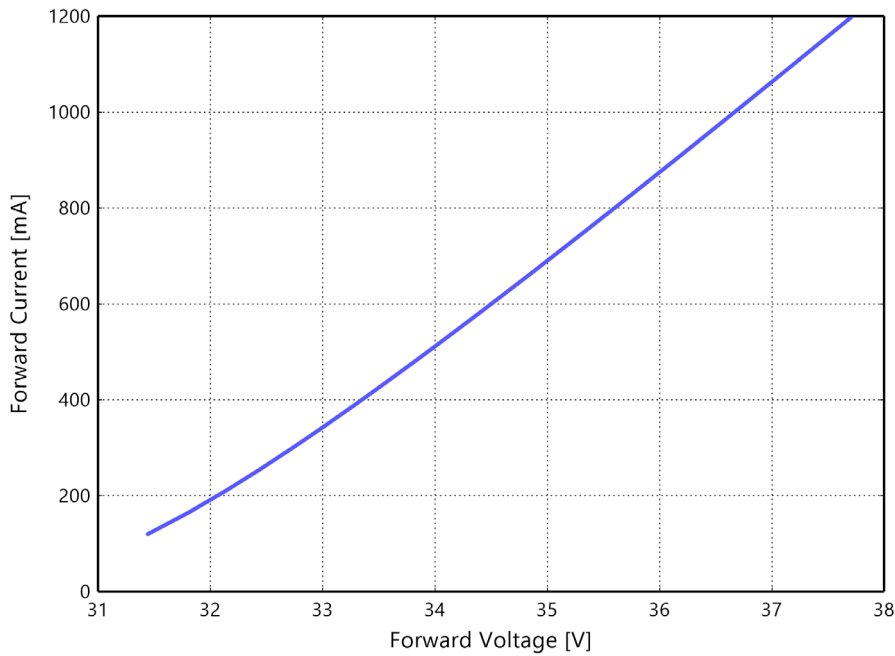

Figure 4e. Typical forward current vs. forward voltage for L2C5-xxxx1205I13Px at $T_j=85^\circ\text{C}$.

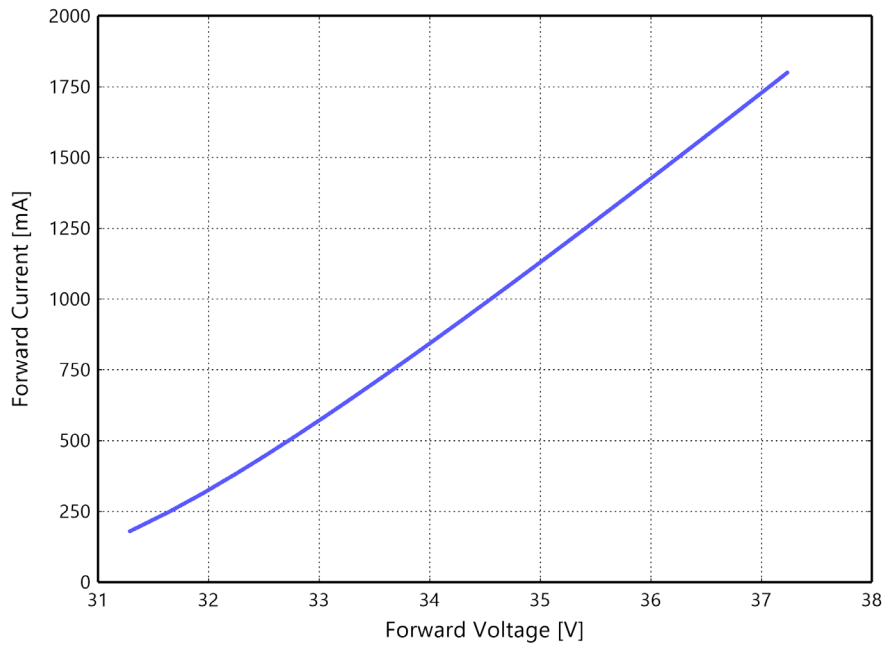

Figure 4f. Typical forward current vs. forward voltage for L2C5-xxxx1208I15Px at $T_j=85^\circ\text{C}$.

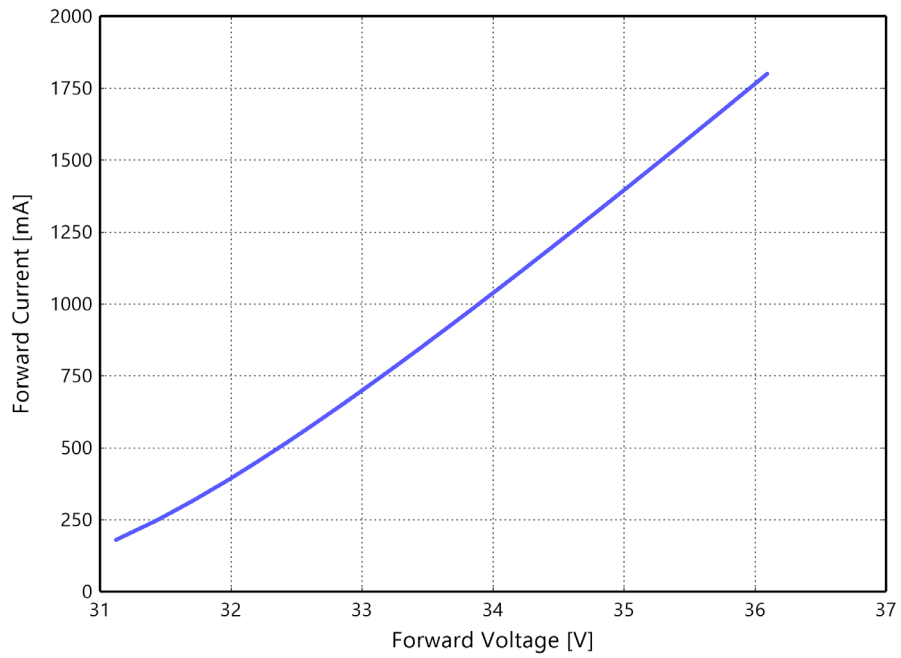

Figure 4g. Typical forward current vs. forward voltage for L2C5-xxxx1210I15Px at $T_j=85^\circ\text{C}$.

Radiation Pattern Characteristics

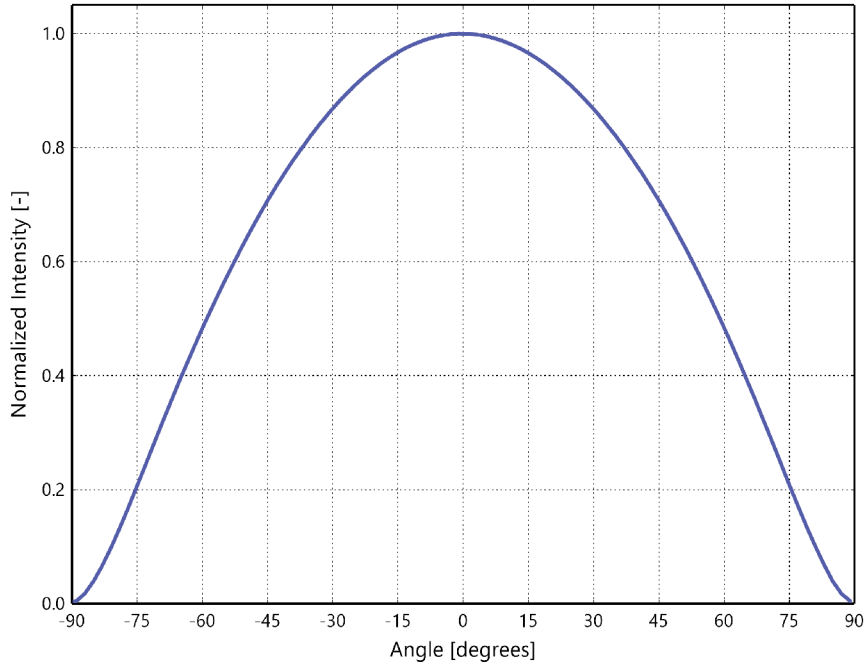

Figure 5. Typical radiation pattern for LUXEON CoB Core Range PW at specified test current, $T_j=85^{\circ}\text{C}$.

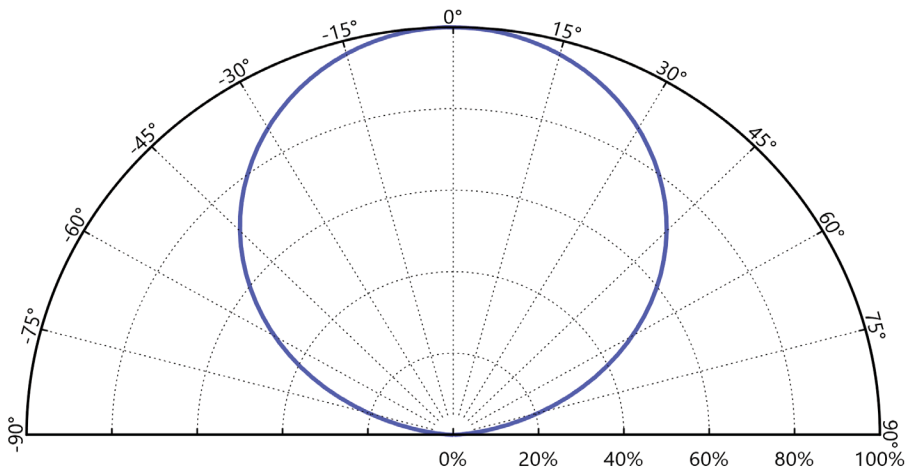

Figure 6. Typical polar radiation pattern for LUXEON CoB Core Range PW at specified test current, $T_j=85^{\circ}\text{C}$.

Color Bin Definitions

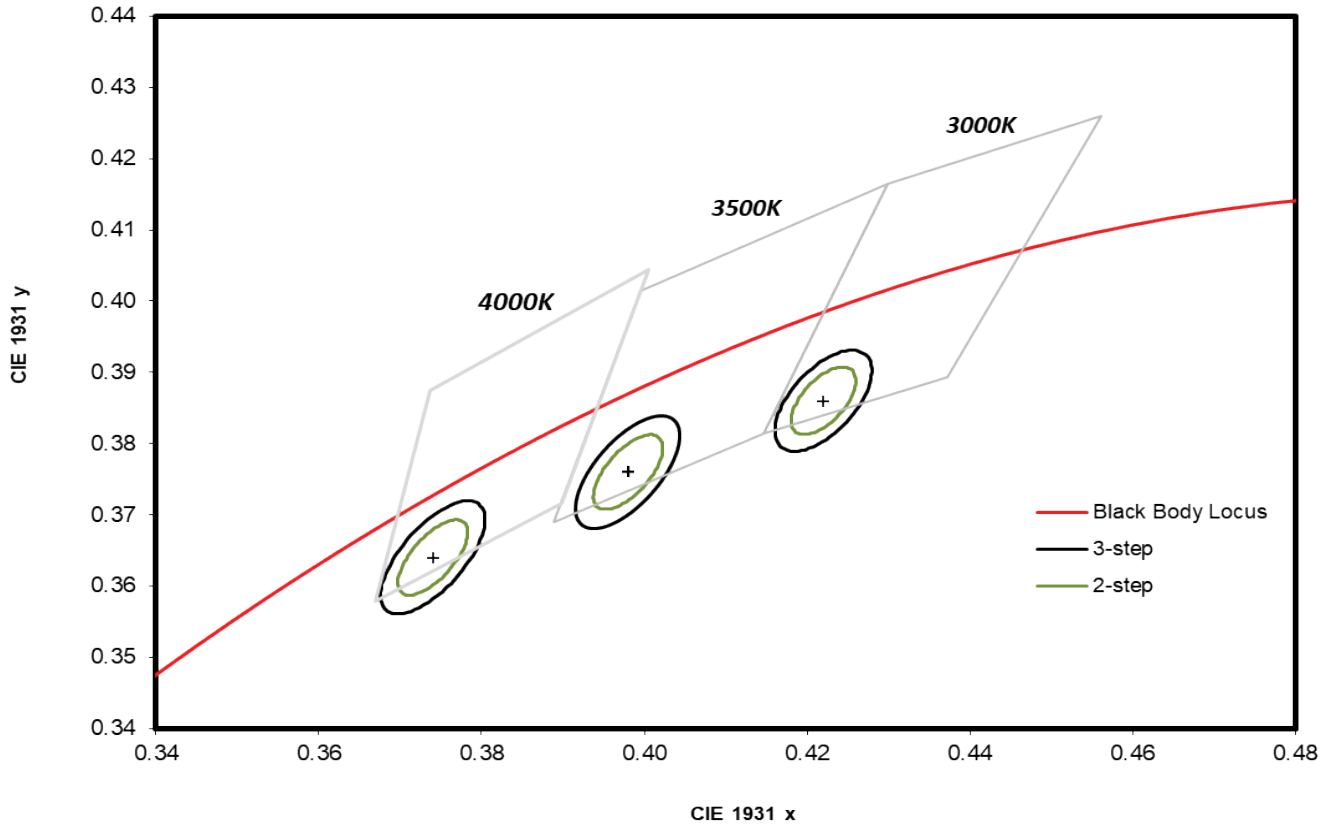

Figure 7. 2-step and 3-step MacAdam ellipse illustration for Table 5.

Table 5. 2-step and 3-step MacAdam ellipse color bin definitions for LUXEON CoB Core Range PW.

NOMINAL CCT	COLOR SPACE	CENTER POINT ^[1] (cx, cy)	MAJOR AXIS, a		MINOR AXIS, b		ELLIPSE ROTATION ANGLE, θ
3000K	2-step, 3-step MacAdam ellipse	(0.422, 0.386)	0.00556	0.00834	0.00272	0.00408	53.20°
3500K	2-step, 3-step MacAdam ellipse	(0.398, 0.376)	0.00618	0.00927	0.00276	0.00414	54.00°
4000K	2-step, 3-step MacAdam ellipse	(0.374, 0.364)	0.00626	0.00939	0.00268	0.00402	53.70°

Notes for Table 5:

1. Lumileds maintains a tolerance of ±0.005 on x and y coordinates in the CIE 1931 color space.

Mechanical Dimensions

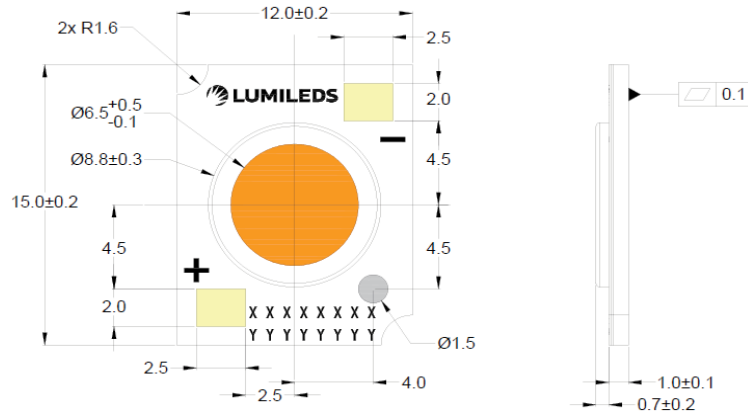

L2C5-xxxx1202x06Px

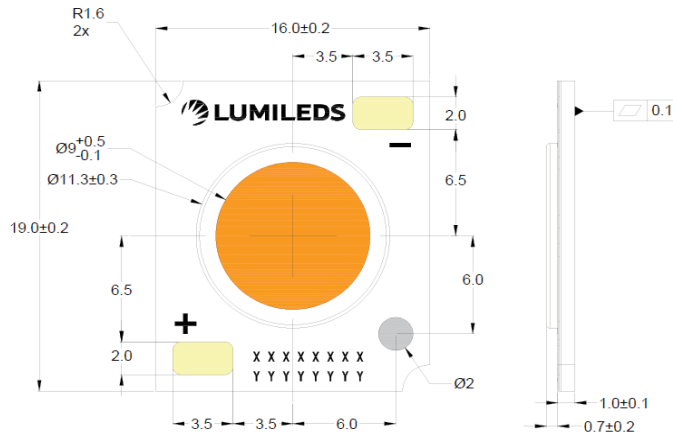

L2C5-xxxx1202x09Px, L2C5-xxxx1203x09Px, L2C5-xxxx1204x09Px

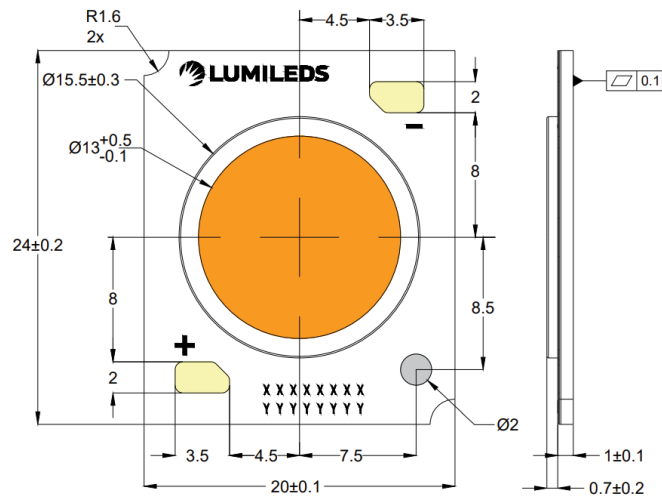

L2C5-xxxx1205x13Px

Figure 8. Mechanical dimensions for LUXEON CoB Core Range PW.

Notes for Figure 8:

1. Drawings not to scale.
2. All dimensions are in millimeters.
3. Dam heights: 0.7mm is applicable to L2C5-xx90xxxxxxxxxx, 0.5mm to L2C5-xx80xxxxxxxxxx.

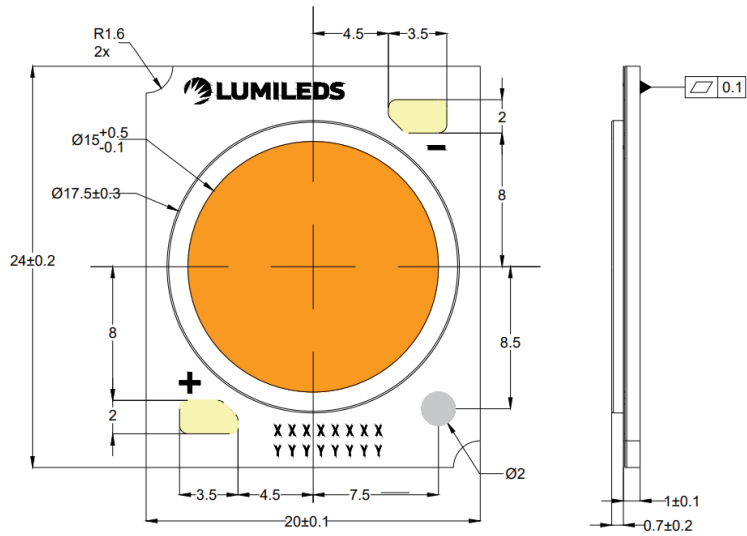

L2C5-xxxx1208x15Px, L2C5-xxxx1210x15Px

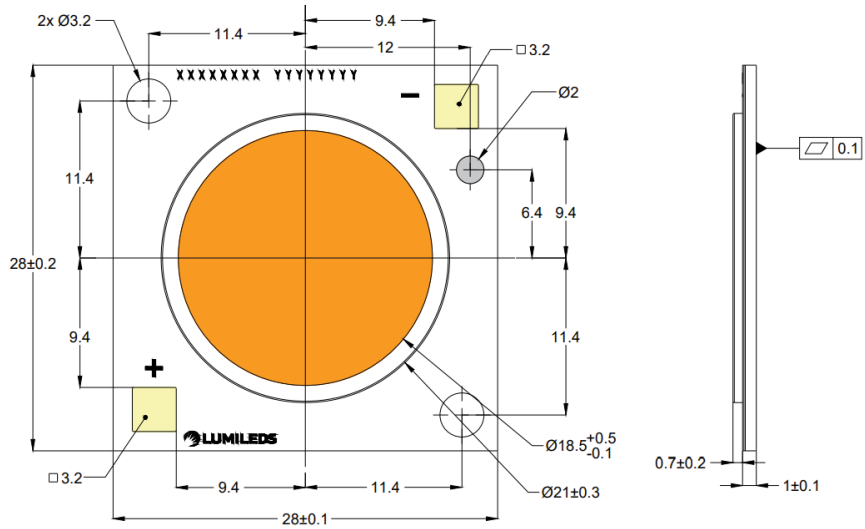

L2C5-xxxx1211x19Px

Figure 8. Mechanical dimensions for LUXEON CoB Core Range PW.

Notes for Figure 8:

1. Drawings not to scale.
2. All dimensions are in millimeters.
3. Dam heights: 0.7mm is applicable to L2C5-xx90xxxxxxxx, 0.5mm to L2C5-xx80xxxxxxxx.

Packaging and Labeling Information

LUXEON CoB Core Range PW LEDs are packaged in tubes then in a carton box. Each tube contains a specified number of LEDs. The LEDs in each tube come from a single category code, ensuring they are all well-matched for light output, color, and forward voltage. Each tube contains a rubber stopper at one end. The tube label has both alphanumeric and bar code information. The carton boxes have printed information providing part numbers with CAT codes that indicate luminous flux, color and forward voltage bins.

Table 6. Number of LEDs per tube for LUXEON CoB Core Range PW.

PART NUMBER	TOTAL UNITS PER TUBE	TOTAL TUBES PER INNER BOX	TOTAL UNITS PER INNER BOX
L2C5-xxxx1202x06Px	20	5	100
L2C5-xxxx1202x09Px	20	5	100
L2C5-xxxx1203x09Px	20	5	100
L2C5-xxxx1204x09Px	20	5	100 </td
L2C5-xxxx1205x13Px	20	5	100
L2C5-xxxx1208x15Px	20	5	100
L2C5-xxxx1210x15Px	20	5	100

Tube

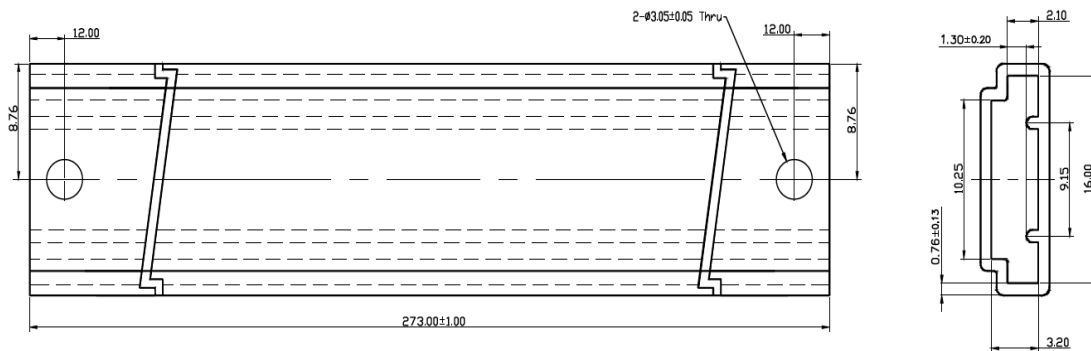

Figure 9a. Tube dimensions for L2C5-xxxx1202x06Px.

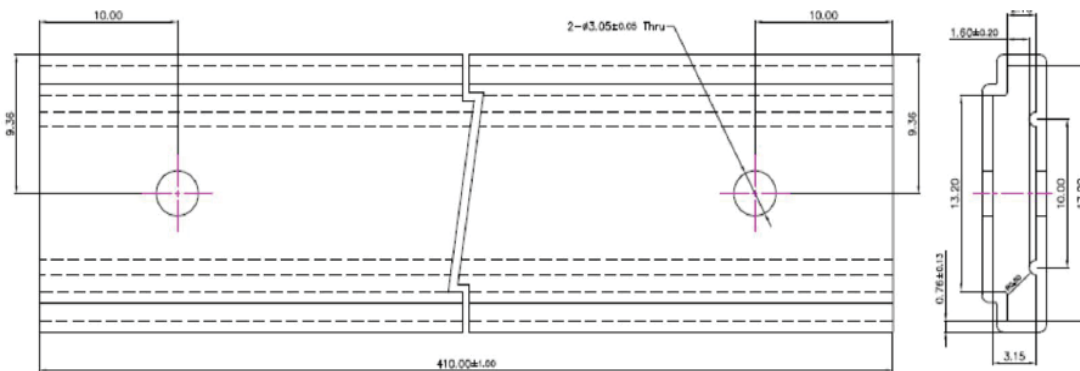

Figure 9b. L2C5-xxxx1202x09Px, L2C5-xxxx1203x09Px and L2C5-xxxx1204x09Px.

Notes for Figures 9a and 9b:

1. Drawings not to scale.
2. All dimensions are in millimeters.

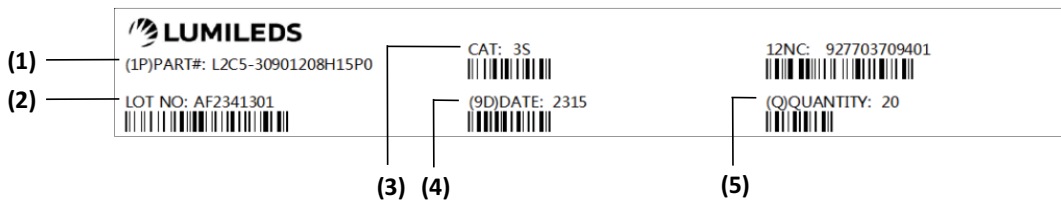

Figure 10. Example of a tube label for LUXEON CoB Core Range PW.

Notes for Figure 10 - Tube Label descriptions for customer use:

Field labels not described are for Lumileds internal use only.

1. Lumileds part number.
2. Unique production lot identification number. This number is required for traceability purpose.
3. Product category code.
4. LED test date in YYYY format.
5. Number of LED emitters in a tube.

Inner Box

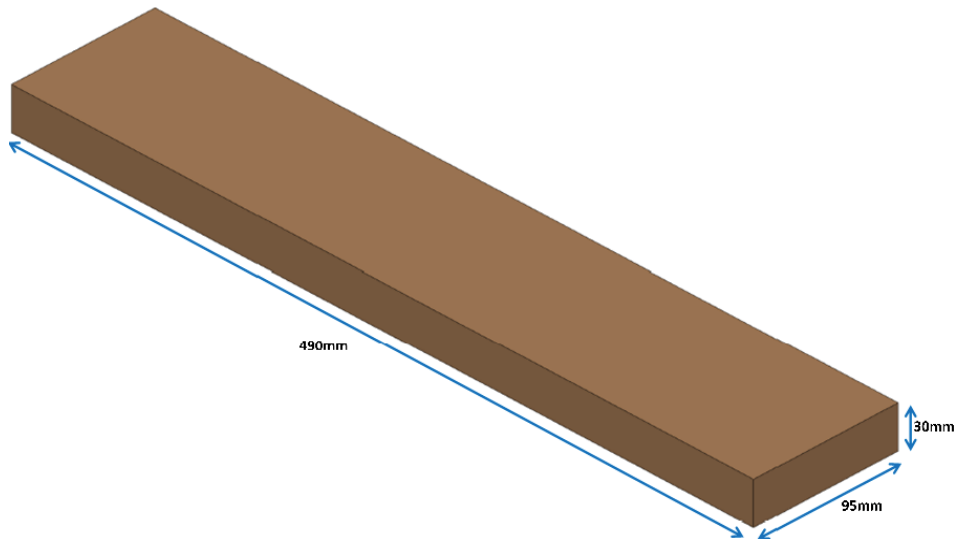

Figure 11. Dimensions for inner box packaging for LUXEON CoB Core Range PW.

Table 7. Inner box information for LUXEON CoB Core Range PW.

BOX TYPE	DIMENSIONS (mm)			AVERAGE WEIGHT (100pcs/box)	AVERAGE WEIGHT (50pcs/box)
	H	L	W		
Inner Box	30	490	95	0.340Kg	0.305Kg



Figure 12. Example of inner box label for LUXEON CoB Core Range PW.

Notes for Figure 12 – Inner Box Label descriptions for customer use:
 Field labels not described are for Lumileds internal use only.

1. Number of LED emitters in a box.
2. Lumileds part number.
3. Customer part number for custom requests only.
4. LED test date in YYWW format.
5. Unique production lot identification number. This number is required for traceability purpose.
6. Product category code.
7. EU regulatory address.

Outer Box

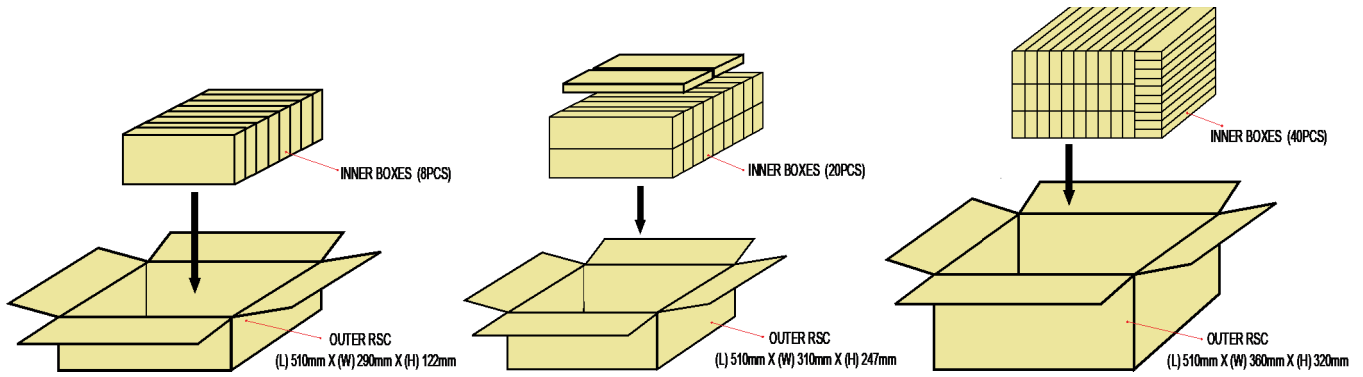

Figure 13. Dimensions for outer box packaging for LUXEON CoB Core Range PW.

Table 8. Outer box information for LUXEON CoB Core Range PW.

BOX TYPE	DIMENSIONS (mm)			MAXIMUM INNER BOXES PER OUTER BOX	MAXIMUM QUANTITY PER OUTER BOX	AVERAGE WEIGHT (100pcs/box)	AVERAGE WEIGHT (50pcs/box)
	H	L	W				
Outer Box 8	122	510	290	8	800	3.05kg	2.77kg
Outer Box 20	247	510	310	20	2000	7.55kg	6.85kg
Outer Box 40	320	510	360	40	4000	15.10kg	13.70kg



Figure 14. Example of outer box label for LUXEON CoB Core Range PW.

Notes for Figure 14 – Outer Box Label descriptions for customer use:

Field labels not described are for Lumileds internal use only.

1. Lumileds part number.
2. Customer part number for custom requests only.
3. Unique production lot identification number. This number is required for traceability purpose.
4. Total number of LED emitters in a shipment box.

About Lumileds

Companies developing automotive, mobile, IoT and illumination lighting applications need a partner who can collaborate with them to push the boundaries of light. With over 100 years of inventions and industry firsts, Lumileds is a global lighting solutions company that helps customers around the world deliver differentiated solutions to gain and maintain a competitive edge. As the inventor of Xenon technology, a pioneer in halogen lighting and the leader in high performance LEDs, Lumileds builds innovation, quality and reliability into its technology, products and every customer engagement. Together with its customers, Lumileds is making the world better, safer, more beautiful—with light.

To learn more about our lighting solutions, visit lumileds.com.



©2024 Lumileds Holding B.V. All rights reserved.
LUXEON is a registered trademark of the Lumileds Holding B.V. in the United States and other countries.

lumileds.com

Neither Lumileds Holding B.V. nor its affiliates shall be liable for any kind of loss of data or any other damages, direct, indirect or consequential, resulting from the use of the provided information and data. Although Lumileds Holding B.V. and/or its affiliates have attempted to provide the most accurate information and data, the materials and services information and data are provided “as is,” and neither Lumileds Holding B.V. nor its affiliates warrants or guarantees the contents and correctness of the provided information and data. Lumileds Holding B.V. and its affiliates reserve the right to make changes without notice. You as user agree to this disclaimer and user agreement with the download or use of the provided materials, information and data. A listing of Lumileds product/patent coverage may be accessed at lumileds.com/patents.

X-ON Electronics

Largest Supplier of Electrical and Electronic Components

Click to view similar products for [High Power LEDs - White category:](#)

Click to view products by [Lumileds manufacturer:](#)

Other Similar products are found below :

[LTW-K140SZR40](#) [LTPL-P00DWS57](#) [LTW-K140SZR30](#) [LZP-D0WW00-0000](#) [LTW-K140SZR57](#) [LTW-K140SZR27](#) [BXRC-35E10K0-D-73](#)
[MP-5050-6100-65-80](#) [KW CSLPM2.CC-8L8M-4L8N](#) [KW CSLPM2.CC-8L8M-4O9Q](#) [KW DPLS32.SB-6H6J-E5P7-EG-Z264](#) [L1V1-](#)
[507003V500000](#) [BXRE-30E2000-C-83](#) [BXRE-27E1000-C-83](#) [BXRE-27G0800-D-83](#) [BXRE-50C2001-C-84](#) [BXRH-35S1001-B-73](#) [BXRH-](#)
[30E0300-B-83](#) [BXRH-30E1000-G-83](#) [115780](#) [LM1311D4W-12B4C12\(Ra4\)-DS](#) [ELJU\(9\)-K40M3-0LTHE-R4000](#) [ELJU\(9\)-K40M3-0LTHE-](#)
[R3000](#) [LM1311D4W-12B2C24\(Ra4\)-DS](#) [KW2 CFLNM2.TK-D2D9-4L07M0-SC6B](#) [XEGAWT-H2-0000-000-00000UT122G](#) [XHP35B-H0-](#)
[0000-0D0ZA230G](#) [XHP35B-H0-0000-0D0ZA440G](#) [XHP35B-H0-0000-0D0ZA227G](#) [XHP35B-H0-0000-0D0ZA235G](#) [CTM-9-4018-90-36-](#)
[TWD6-F3-3](#) [CVM-32-56-95-54-AC00-F2-2](#) [SST-12-W65S-A120-H4652](#) [CXM-4-24-90-18-AC40-F5-2](#) [CXM-4-22-90-18-AC40-F5-2](#) [CTM-](#)
[14-4018-90-36-TWD6-F3-3](#) [CTM-6-4018-90-36-TWD6-F3-3](#) [LM002H384W-7B3C12\(Ra5\)\(ANSI-2700K\)](#) [LM002H384W-](#)
[9B4C12\(Ra2\)\(ANSI-2700K\)](#) [LM002H384W-7B3C12\(Ra7\)\(ANSI-2700K\)](#) [LM002H384W-9B4C12\(Ra2\)\(ANSI-3000K\)](#) [LM002H384W-](#)
[9B4C12\(Ra4\)-S\(ANSI-3500K\)](#) [LM002H384W-9B4C12\(Ra5\)\(ANSI-4000K\)](#) [LM002H384W-7B3C12\(Ra2\)-S\(ANSI-3000K\)](#) [LM002H384W-](#)
[7B3C12\(Ra5\)\(ANSI-4000K\)](#) [LM002H384W-7B3C12\(Ra7\)\(ANSI-4000K\)](#) [HL-LM002H384W-5B2C5\(Ra4\)\(ANSI-3000K\)](#) [HL-](#)
[LM002H384W-7B1C18\(Ra4\)\(ANSI-6000K\)](#) [LM002H384W-7B3C12\(Ra5\)\(ANSI-3500K\)](#) [HL-LM002H384W-5B2C5\(Ra4\)\(ANSI-4000K\)](#)