

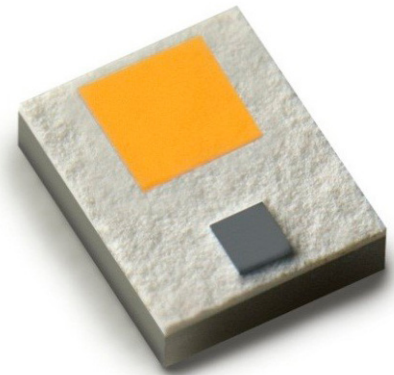

LUXEON F PC Amber

Industry-leading solutions for turn applications

LUXEON F PC Amber and LUXEON F Plus PC Amber LEDs are the only automotive LEDs that deliver design flexibility and advanced functionality. These products, with their miniaturized form factor are designed to support turn signal and side marker applications. The Lumileds automotive binning structure meets both SAE and ECE color specifications and is hot binned at 85°C, consistent with actual automotive operational environments. LUXEON F PC Amber and LUXEON F Plus PC Amber provide industry-leading solutions for your front and rear turn applications. All LUXEON F LEDs are AEC-Q101 qualified.



FEATURES AND BENEFITS

- Higher drive current capability for increased flux performance
- Low thermal resistance for better hot lumen performance
- Standard packaging for low cost and ease of manufacturability
- Hot binned at 85°C monopulse (MP) drive current to match closer to operating conditions

PRIMARY APPLICATIONS

- Daytime Running Lights
- Side Marker
- Turn
 - Front Turn
 - Rear Turn

Table of Contents

General Product Information	2
Product Test Conditions	2
Part Number Nomenclature	2
Environmental Compliance	2
Performance Characteristics	3
Product Selection Guide	3
Optical Characteristics	3
Electrical and Thermal Characteristics	4
Absolute Ratings	4
Characteristic Curves	5
Spectral Power Distribution Characteristics	5
Light Output Characteristics	5
Forward Current Characteristics	7
Color Shift Characteristics	8
Radiation Pattern Characteristics	9
Operating Limits Characteristics	9
Product Bin and Labeling Definitions	10
Designing with LUXEON F	10
Decoding Product Bin Labeling	10
Luminous Flux Bins	10
Color Codes	11
Forward Voltage Bins	12
Mechanical Dimensions	12
Packaging Information	13
Pocket Tape Dimensions	13
Reel Dimensions	13

General Product Information

Product Test Conditions

LUXEON F PC Amber LEDs are tested and binned using a 20ms monopulse (MP) at 350mA drive current for LUXEON F PC Amber and 1000mA for LUXEON F Plus PC Amber, junction temperature, T_j , of 85°C.

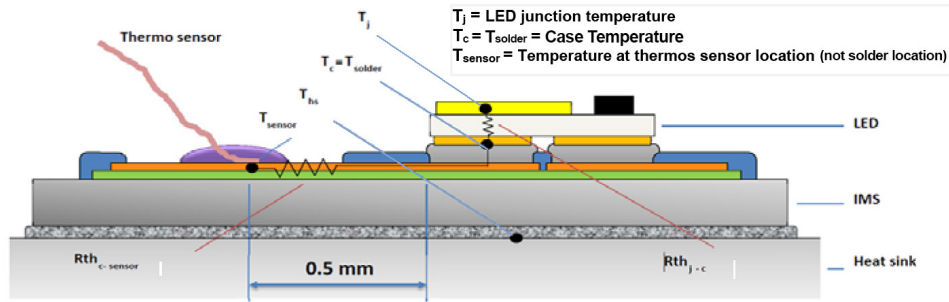

Figure 1: Example of case temperature location on sample board for LUXEON F.

Part Number Nomenclature

Part numbers for LUXEON F PC Amber and LUXEON F Plus PC Amber follow the convention below:

L F M H – **A B C** – **E F G H**

Where:

- M H – designates hot binning
- A** – designates color variant (L=PC Amber)
- B** – designates die size (1=1mm²)
- C** – designates binning current (A=350mA and C=1000mA)
- E** – designates future product offerings
- F G H** – designates minimum luminous flux

Therefore, the following part number is used for a LUXEON F Plus PC Amber 1000mA with a minimum luminous flux of 150 lumens:

L F M H – **L 1 C** – **0 1 5 0**

Environmental Compliance

Lumileds LLC is committed to providing environmentally friendly products to the solid-state lighting market. LUXEON F PC Amber is compliant to the European Union directives on the restriction of hazardous substances in electronic equipment, namely the RoHS Directive 2011/65/EU and REACH Regulation (EC) 1907/2006. Lumileds LLC will not intentionally add the following restricted materials to its products: lead, mercury, cadmium, hexavalent chromium, polybrominated biphenyls (PBB) or polybrominated diphenyl ethers (PBDE).

Performance Characteristics

Product Selection Guide

Table 1. Product selection for LUXEON F PC Amber and LUXEON F Plus PC Amber at 20ms MP specified test current, $T_j=85^\circ\text{C}$.

PRODUCT	MINIMUM LUMINOUS FLUX (lm) ^[1]	TEST CURRENT (mA)	PART NUMBER
LUXEON F PC Amber	60	350	LFMH-L1A-0060
	70	350	LFMH-L1A-0070
	80	350	LFMH-L1A-0080
LUXEON F Plus PC Amber	142	1000	LFMH-L1C-0142
	153	1000	LFMH-L1C-0153
	164	1000	LFMH-L1C-0164
	174	1000	LFMH-L1C-0174
	185	1000	LFMH-L1C-0185

Notes for Table 1:

1. Lumileds maintains a tolerance of $\pm 6.5\%$ on luminous flux measurements.

Optical Characteristics

Table 2. Typical optical characteristics for LUXEON F PC Amber and LUXEON F Plus PC Amber at 20ms MP specified test current, $T_j=85^\circ\text{C}$.

PART NUMBER	DOMINANT WAVELENGTH (nm)		SPECTRAL HALF-WIDTH ^[3] (nm) $\Delta\lambda_{1/2}$	TEMPERATURE COEFFICIENT OF DOMINANT WAVELENGTH (nm/ $^\circ\text{C}$)	TOTAL INCLUDED ANGLE ^[1] $\theta_{0.90V}$	TYPICAL VIEWING ANGLE ^[2] $2\theta_{1/2}$
	MINIMUM	MAXIMUM				
LFMH-L1x-0xxx	588.8	592.6	75	0.06	164	118

Notes for Table 2:

1. Total angle at which 90% of total luminous flux is captured.
2. Viewing angle is the off axis angle from the LED centerline where the luminous intensity is $1/2$ of the peak value.
3. Spectral width at $1/2$ of the peak intensity.

Electrical and Thermal Characteristics

Table 3. Electrical and thermal characteristics for LUXEON F PC Amber and LUXEON F Plus PC Amber at 20ms MP specified test current, $T_j=85^\circ\text{C}$.

PART NUMBER	FORWARD VOLTAGE ^[1] (V)		DYNAMIC RESISTANCE ^[2] (Ω) R_D	TEMPERATURE COEFFICIENT OF FORWARD VOLTAGE ^[3] (mV/ $^\circ\text{C}$) $\Delta V_f / \Delta T_j$	THERMAL RESISTANCE JUNCTION TO CASE ($^\circ\text{C}/\text{W}$)			
	MINIMUM	MAXIMUM			$R\theta_{j-c\text{el}}$ ^[4]		$R\theta_{j-c\text{real}}$ ^[5]	
					TYPICAL	MAXIMUM	TYPICAL	MAXIMUM
LFMH-L1A-0xxx	2.55	3.27	0.3	-2.1	2.50	2.80	3.27	3.66
LFMH-L1C-0xxx	2.55	3.27	0.2	-2.5	2.50	2.80	3.04	3.40

Notes for Table 3:

- Lumileds maintains a tolerance of $\pm 0.06\text{V}$ on forward voltage measurements.
- Dynamic resistance is the inverse of the slope in linear forward voltage model for LEDs. See forward voltage vs. forward current Figure 5.
- Measured between $T_c=80^\circ\text{C}$ and $T_c=90^\circ\text{C}$ at binning current.
- $R\theta_{j-c\text{el}}$: Electrical thermal resistance (junction to case).
- $R\theta_{j-c\text{real}}$: Real thermal resistance (junction to case) with wall plug efficiency included. Reference JESD51-51, JESD51-14, 4.1.3.

Absolute Ratings

Table 4. Absolute ratings for LUXEON F PC Amber and LUXEON F Plus PC Amber.

PARAMETER	PERFORMANCE
Minimum DC Forward Current	50mA
Maximum DC Forward Current	700mA for LUXEON F PC Amber 1000mA for LUXEON F Plus PC Amber
Maximum Junction Temperature ^[1]	135 $^\circ\text{C}$
Operating Case Temperature at Test Current ^[1]	-40 $^\circ\text{C}$ to 110 $^\circ\text{C}$
Operating Case Temperature at Maximum Current ^[1]	-40 $^\circ\text{C}$ to 110 $^\circ\text{C}$
Storage Temperature	-40 $^\circ\text{C}$ to 130 $^\circ\text{C}$
Soldering Temperature	240 $^\circ\text{C}$
Allowable Reflow Cycles	3
Minimum ESD performance ^[2]	$\pm 8\text{ kV HBM}$, $\pm 400\text{ V MM}$
Reverse Voltage (V_r)	LUXEON F LEDs are not designed to be driven in reverse bias
Autoclave Conditions	121 $^\circ\text{C}$ at 2 ATM 100% Relative Humidity for 96 Hours Maximum

Notes for Table 4:

- Proper current derating must be observed to maintain junction temperature below the maximum, so that the LED is maintained below the maximum rated operating case temperature. LUXEON F LEDs driven at or above the maximum rated operating case temperature may have shorter lifetime.
- Measured using human body model (per ANSI/ESDA/JEDEC JS-001-2010) and charged device model (per JESD22-C101F).

Characteristic Curves

Spectral Power Distribution Characteristics

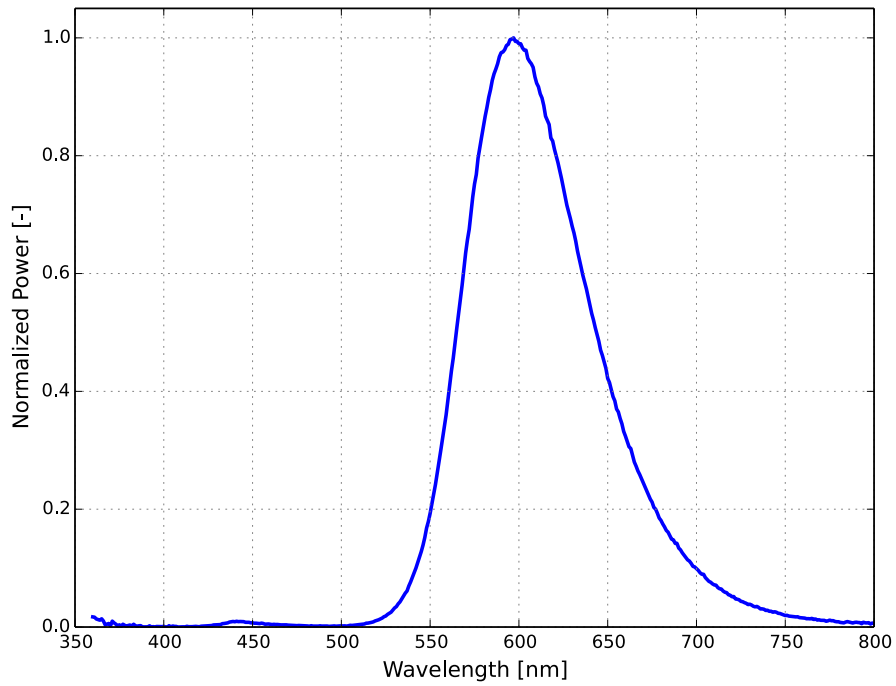

Figure 2: Typical normalized power vs. wavelength for LUXEON F PC Amber and LUXEON F Plus PC Amber at test current, $T_j=85^\circ\text{C}$.

Light Output Characteristics

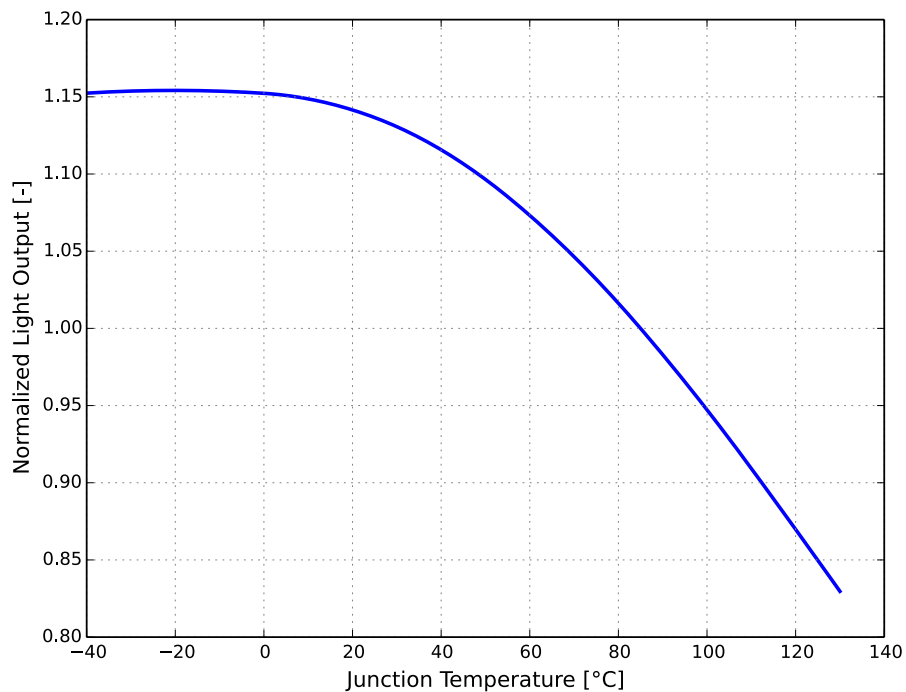

Figure 3a: Typical normalized light output vs. junction temperature for LUXEON F PC Amber at 20ms MP, 350mA.

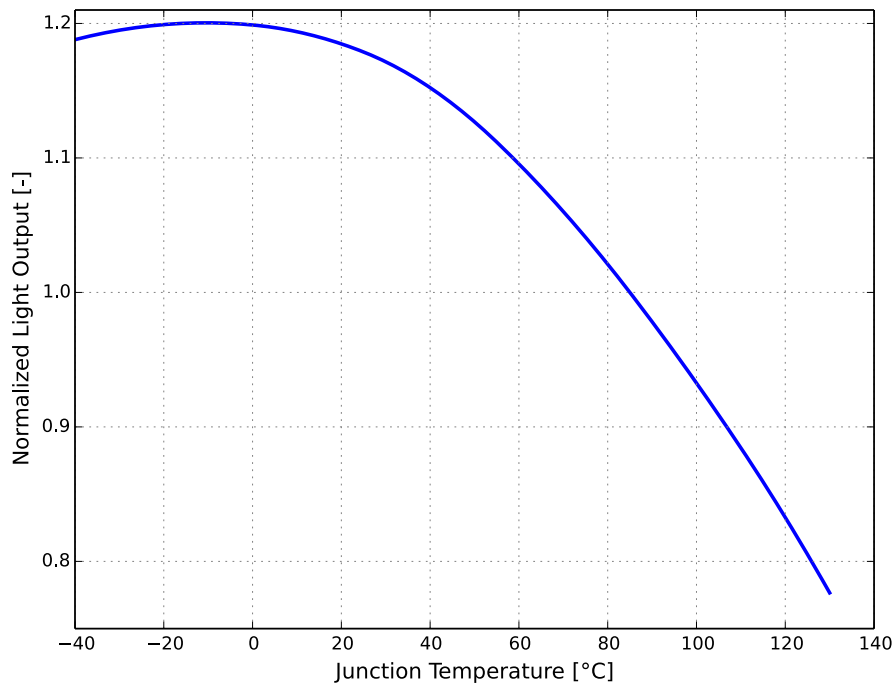

Figure 3b: Typical normalized light output vs. junction temperature for LUXEON F Plus PC Amber at 20ms MP, 1000mA.

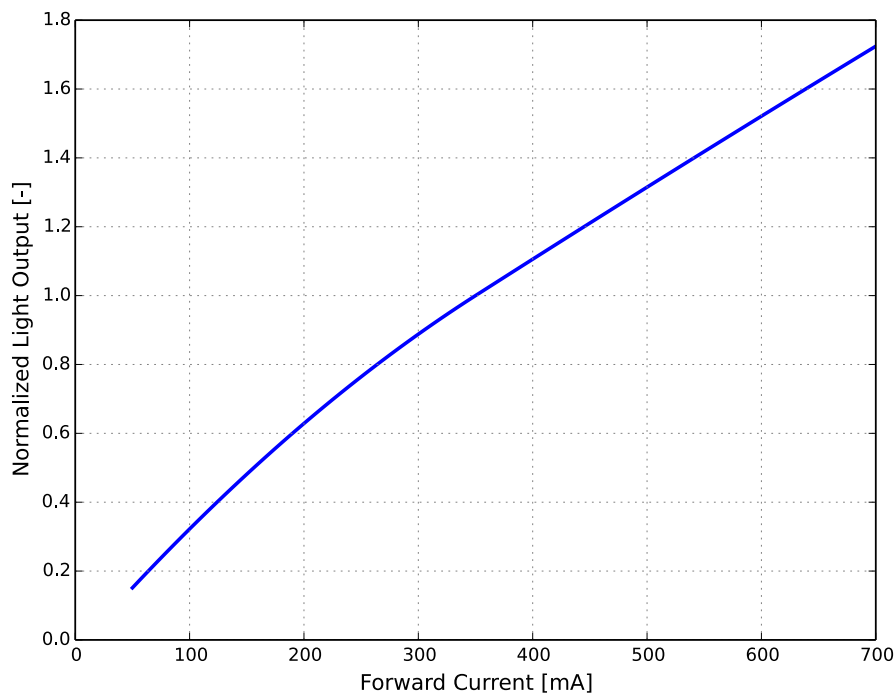

Figure 4a: Typical normalized light output vs. forward current for LUXEON F PC Amber at $T_j=85^\circ\text{C}$.

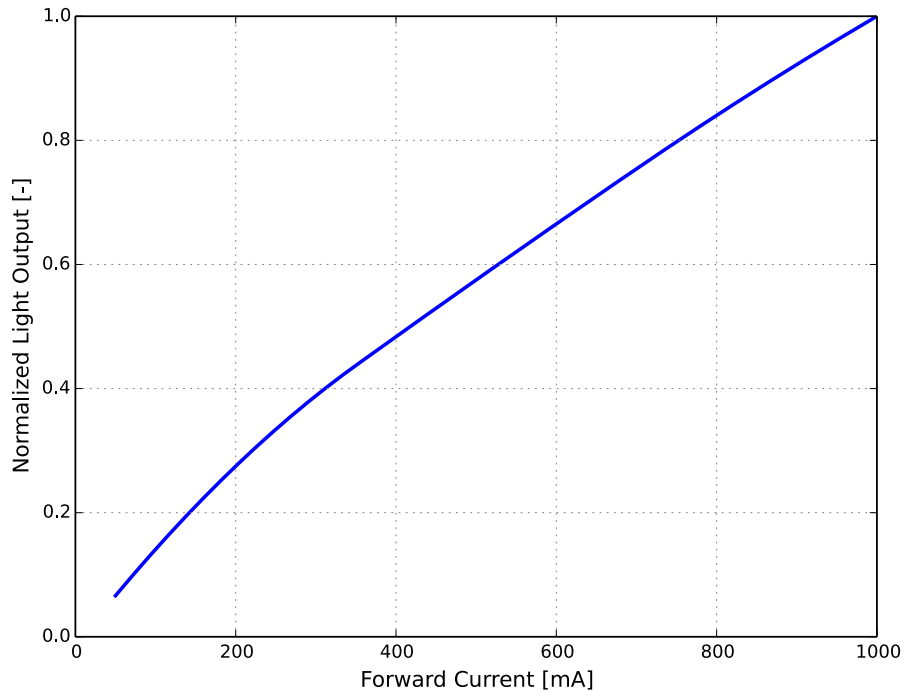

Figure 4b: Typical normalized light output vs. forward current for LUXEON F Plus PC Amber at $T_j=85^\circ\text{C}$.

Forward Current Characteristics

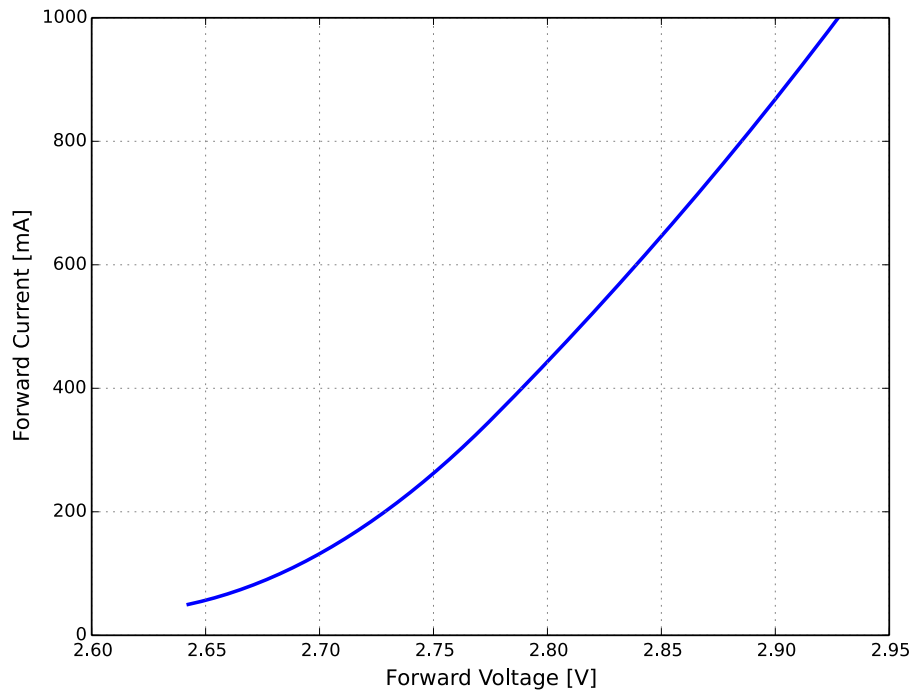

Figure 5: Typical forward current vs. forward voltage for LUXEON F PC Amber and LUXEON F Plus PC Amber at 20ms MP at specified test temperature.

Color Shift Characteristics

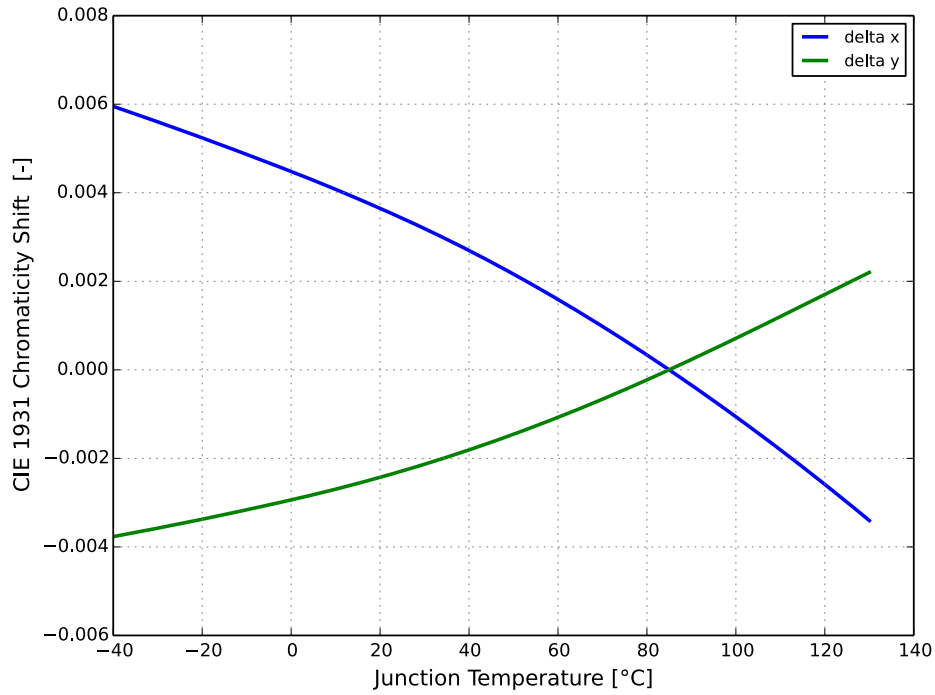

Figure 6a: Typical color shift in CIE1931 x and y coordinates for LUXEON F PC Amber at 20ms MP, 350mA.

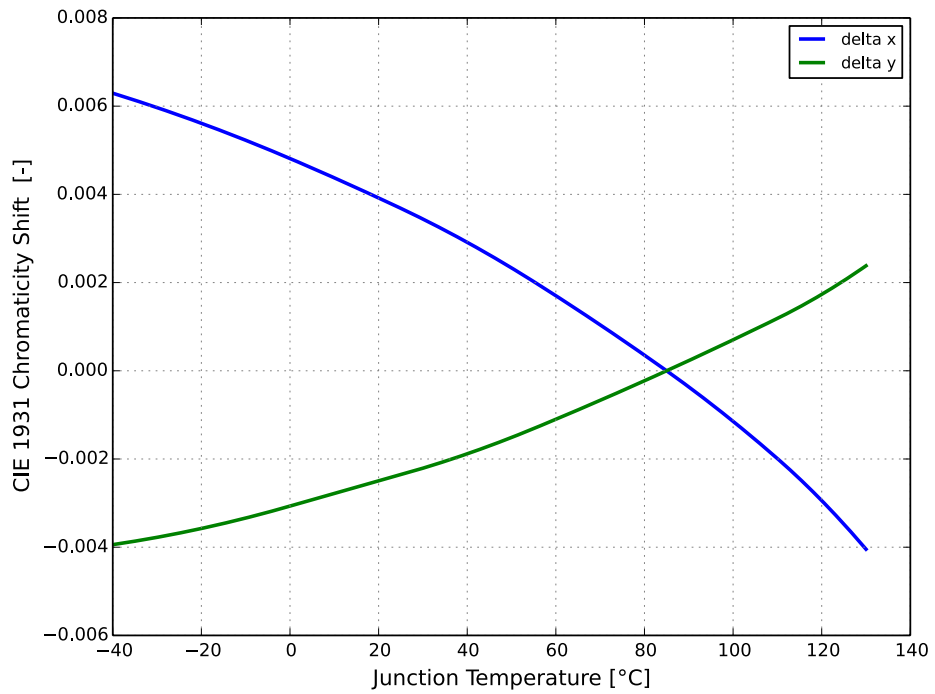

Figure 6b: Typical color shift in CIE1931 x and y coordinates for LUXEON F Plus PC Amber at 20ms MP, 1000mA.

Radiation Pattern Characteristics

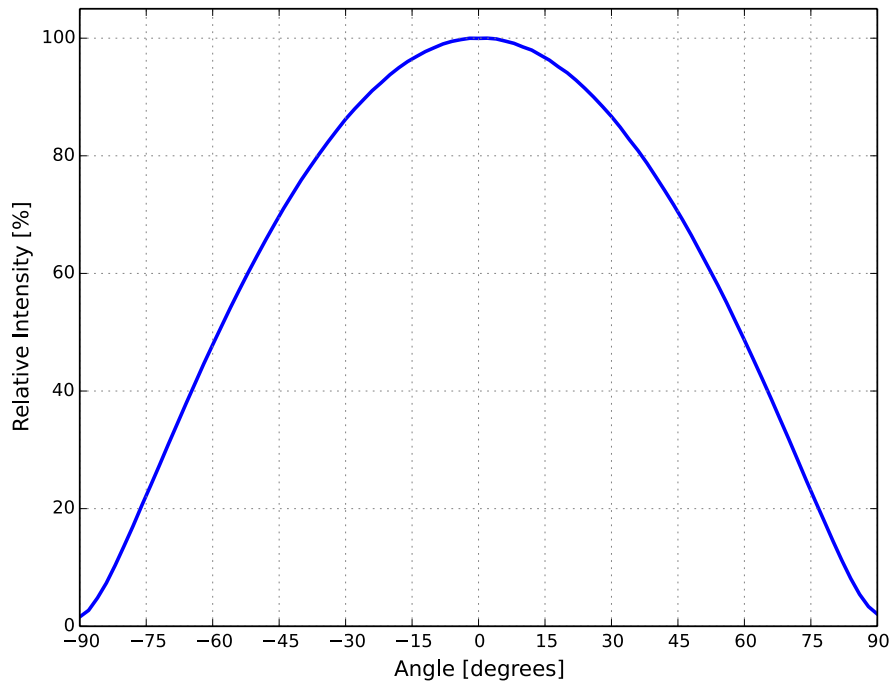

Figure 7: Typical luminous radiation pattern for LUXEON F PC Amber and LUXEON F Plus PC Amber at 20ms MP specified test current, $T_j=85^{\circ}\text{C}$.

Operating Limits Characteristics

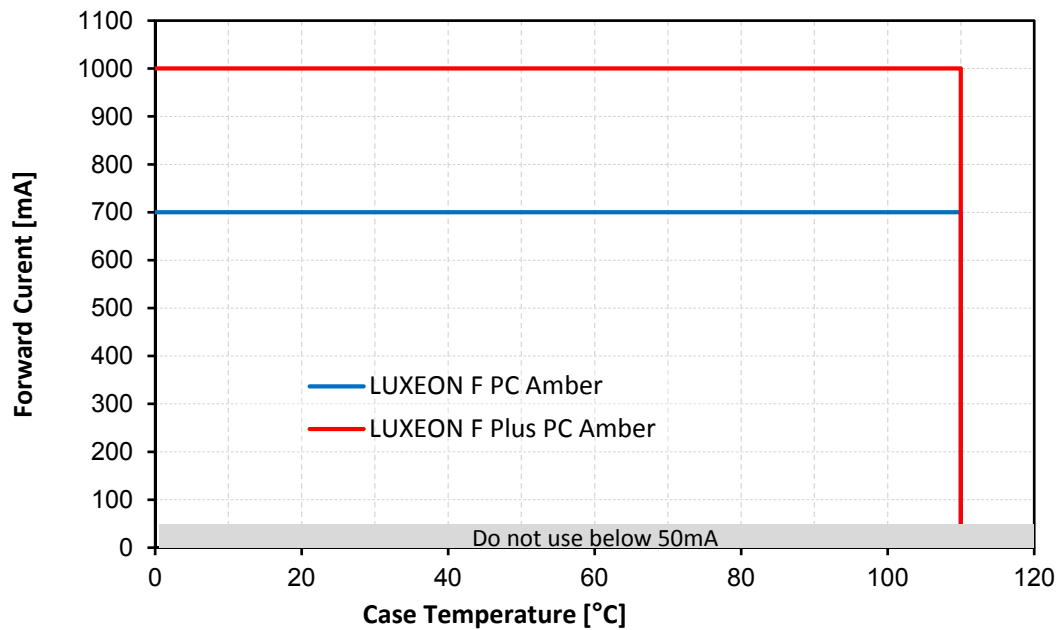

Figure 8: Maximum forward current vs. case temperature for LUXEON F PC Amber and LUXEON F Plus PC Amber.

Product Bin and Labeling Definitions

Designing with LUXEON F

Flux bins supportable for car programs depend on product color and program start- and end-of-production date. Flux roadmaps by year and product color are maintained and available from the sales representative. Please contact local sales representative to request the flux bin range with best supportability for program timing.

Decoding Product Bin Labeling

In the manufacturing of semiconductor products, there are variations in performance around the average values given in the technical datasheets. For this reason, Lumileds bins the LED components for luminous flux or radiometric power, forward voltage, color point, peak wavelength, or dominant wavelength.

LUXEON F PC Amber and LUXEON F Plus PC Amber LEDs are labeled using a 3-digit alphanumeric CAT code following the format below:

A B C

- A** – designates luminous flux bin (example: D=70 to 80 lumens)
- B** – designates color code (example: A or B)
- C** – designates forward voltage bin (example: B=2.55V to 2.79V)

Therefore, a LUXEON F PC Amber with a lumen range of 70 to 80, color bin of A and a forward voltage of 2.55V to 2.79V has the following CAT code:

D A B

Luminous Flux Bins

Tables 5a and 5b list the standard photometric luminous flux bins for LUXEON F PC Amber and LUXEON F Plus PC Amber emitters. Product availability in a particular bin varies by color and platform start of production date. Contact local sales representative for best supportability of programs.

Table 5a. Luminous flux bin definitions for LUXEON F PC Amber at 20ms MP specified test current, $T_j = 85^\circ\text{C}$.

BIN	LUMINOUS FLUX (lm)	
	MINIMUM	MAXIMUM
C	60	70
D	70	80
E	80	90
F	90	100
G	100	110
H	110	120
J	120	130

Notes for Table 5a:

1. Lumileds maintains a tolerance of $\pm 6.5\%$ on luminous flux measurements.

Table 5b. Luminous flux bin definitions for LUXEON F Plus PC Amber at 20ms MP specified test current, $T_j=85^\circ\text{C}$.

BIN	LUMINOUS FLUX (lm)	
	MINIMUM	MAXIMUM
K	142	153
L	153	164
M	164	174
N	174	185
P	185	196
Q	196	207
R	207	218
S	218	240

Notes for Table 5b:

1. Lumileds maintains a tolerance of $\pm 6.5\%$ on luminous flux measurements.

Color Codes

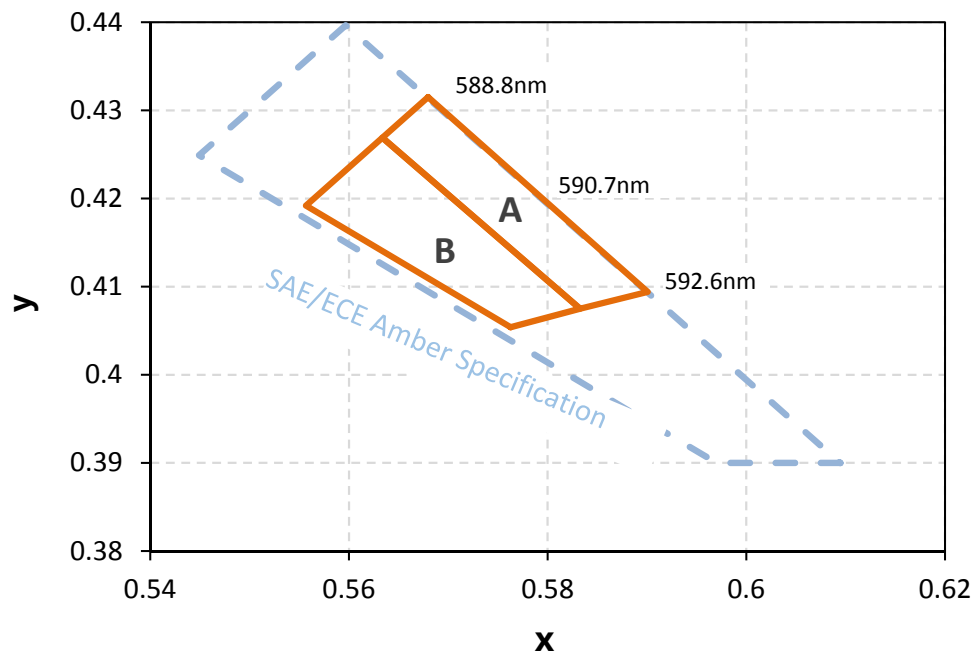

Figure 9: Color binning structure in CIE 1931 color space for LUXEON F PC Amber and LUXEON F Plus PC Amber.

Table 6. Color code definitions for LUXEON F PC Amber and LUXEON F Plus PC Amber.

CODE	x	y
A	0.568	0.4315
	0.5634	0.4269
	0.5833	0.4075
	0.5901	0.4094
B	0.5763	0.4054
	0.5833	0.4075
	0.5634	0.4269
	0.5557	0.4192

Notes for Table 6:

1. Lumileds maintains a tester tolerance of ± 0.005 on x and y color coordinates.
2. Test conditions at test current with a pulse duration of 20ms.

Forward Voltage Bins

Table 7. Forward voltage bin definitions for LUXEON F PC Amber and LUXEON F Plus PC Amber.

BIN	FORWARD VOLTAGE (V)	
	MINIMUM	MAXIMUM
B	2.55	2.79
C	2.79	3.03
D	3.03	3.27

Notes for Table 7:

1. Lumileds maintains a tolerance of $\pm 0.06V$ on forward voltage measurements.
2. Although several bins are outlined, product availability in a particular bin varies by production run and by product performance.

Mechanical Dimensions

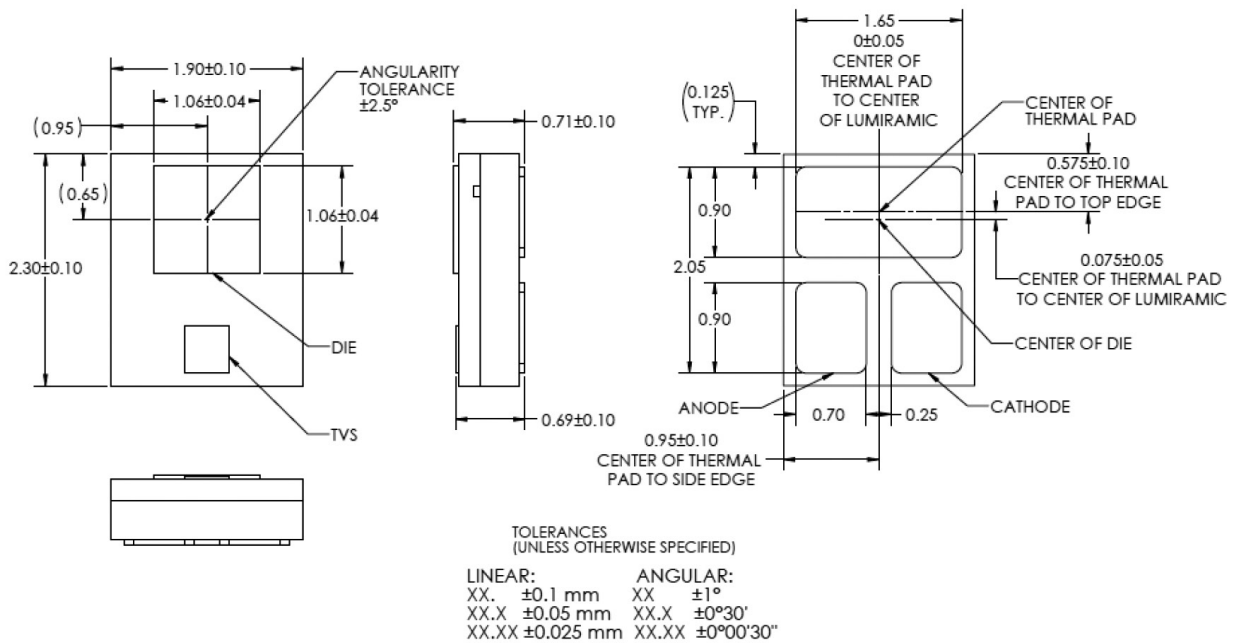

Figure 10: Mechanical dimensions for LUXEON F PC Amber and LUXEON F Plus PC Amber.

Notes for Figure 10:

1. Drawings are not to scale.
2. All dimensions are in millimeters.

Packaging Information

Pocket Tape Dimensions

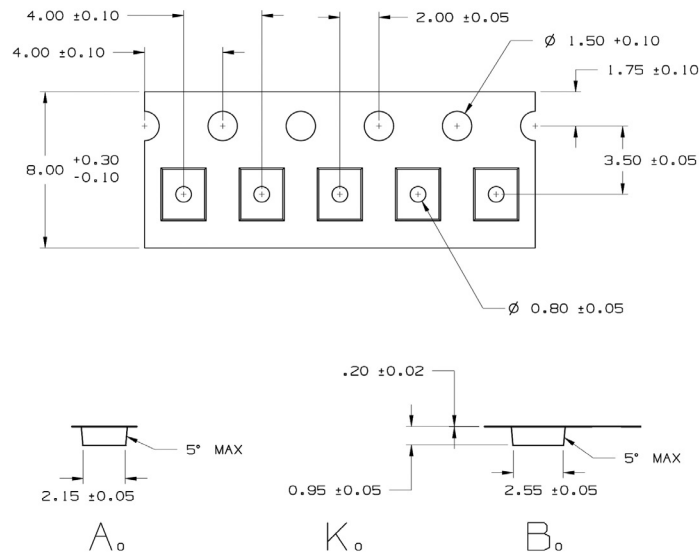

Figure 11: Pocket tape dimensions for LUXEON F PC Amber and LUXEON F Plus PC Amber.

Notes for Figure 11:

1. Drawings are not to scale.
2. All dimensions are in millimeters.
3. A_0 is the width of pocket. K_0 is the depth of pocket. B_0 is the height of pocket.

Reel Dimensions

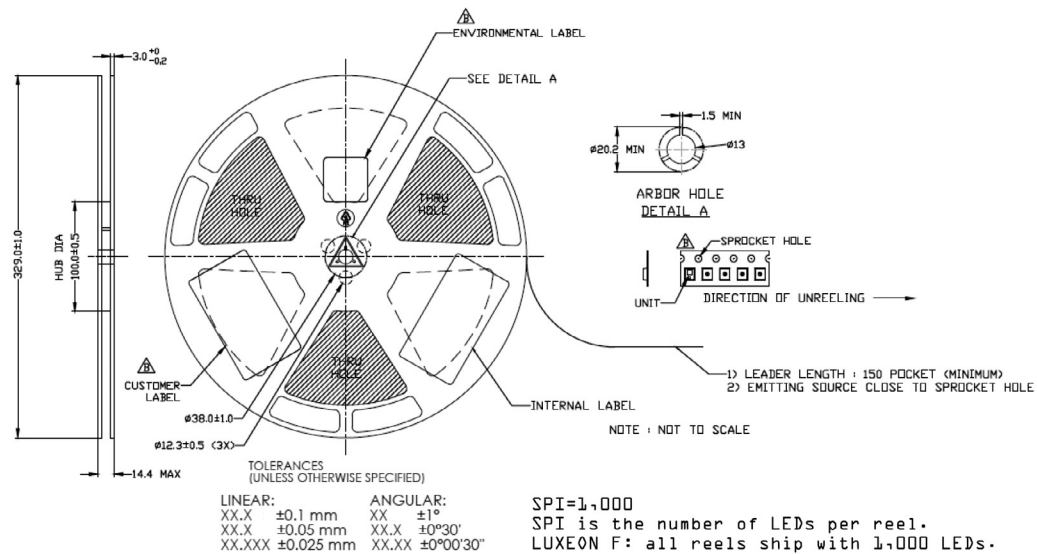

Figure 12: Reel dimensions for LUXEON F PC Amber and LUXEON F Plus PC Amber.

Notes for Figure 12:

1. Drawings are not to scale.
2. All dimensions are in millimeters.

About Lumileds

Lumileds is the light engine leader, delivering innovation, quality and reliability.

For 100 years, Lumileds commitment to innovation has helped customers pioneer breakthrough products in the automotive, consumer and illumination markets.

Lumileds is shaping the future of light with our LEDs and automotive lamps, and helping our customers illuminate how people see the world around them.

To learn more about our portfolio of light engines, visit lumileds.com.



©2015 Lumileds Holding B.V. All rights reserved.
LUXEON is a registered trademark of the Lumileds Holding B.V.
in the United States and other countries.

lumileds.com

Neither Lumileds Holding B.V. nor its affiliates shall be liable for any kind of loss of data or any other damages, direct, indirect or consequential, resulting from the use of the provided information and data. Although Lumileds Holding B.V. and/or its affiliates have attempted to provide the most accurate information and data, the materials and services information and data are provided "as is," and neither Lumileds Holding B.V. nor its affiliates warrants or guarantees the contents and correctness of the provided information and data. Lumileds Holding B.V. and its affiliates reserve the right to make changes without notice. You as user agree to this disclaimer and user agreement with the download or use of the provided materials, information and data.

X-ON Electronics

Largest Supplier of Electrical and Electronic Components

Click to view similar products for [High Power LEDs - Single Colour](#) category:

Click to view products by [Lumileds](#) manufacturer:

Other Similar products are found below :

[GA CSSPM1.23-KTLP-W3-0-350-R18](#) [L135-L567003500000](#) [L1CU-VLT1000000000](#) [L1C1-VLT1000000000](#) [KY DDLM31.FY-8H7J-5F5G-W4A4-140-R18](#) [KY DDLM31.23-8F5H-36-C4U4-140-R18](#) [LS G6SP.01-7C8D-68-G3R3](#) [KR DDLM31.23-5G7H-25-C4U4-140-R18](#) [KT DDLM31.13-6H7J-36-W4A4-140-R18](#) [KS DDLM31.23-8E6G-68-C4U4-140-R18](#) [KB DDLM31.13-6D7E-25-24A4-140-R18](#) [GT CS8PM1.13-LSLU-26-1-350-B-R18](#) [L128-PCB1003500000](#) [GH CS8PM1.24-4T2U-1-0-350-R33](#) [GT CSHPM1.13-LSLU-26-1-350-B-R18](#) [XPEBRY-L1-0000-00S02](#) [XQEBLU-00-0000-000000Z02](#) [SPHWH2L3D30ED4V0H3](#) [XQEBLU-00-0000-000000202](#) [LUWCQ7P-LPLR-5E8G-1-K](#) [LTPL-C034UVH410](#) [XPEBBL-L1-R250-00302](#) [XPEROY-L1-0000-00B02](#) [GD CSSPM1.14-UOVJ-W4-1](#) [LST1-01F06-GRN1-00](#) [KY DMLQ31.23-HYKX-46-J3T3](#) [GD CS8PM1.14-UOVJ-W4-1](#) [XQEEPR-00-0000-000000A01-SB01](#) [LST1-01G01-UV02-00](#) [LST1-01F06-RYL1-00](#) [LST1-01F06-FRD1-00](#) [LST1-01G01-UV01-00](#) [LST1-01G01-PRD1-00](#) [XQEROY-00-0000-000000Q01-SB01](#) [LST1-01G01-UV03-00](#) [LST1-01G01-RYL1-00](#) [L135-A589003500000](#) [L135-L567L00000000](#) [L1C1-GRN1000000000](#) [LA G6SP-DAFA-24-1](#) [LS G6SP-CADB-1-1-Z](#) [LY H9PP-HZJZ-46-1](#) [SMTL6-RC](#) [MLEBLU-A1-0000-000U01](#) [MLEBLU-A1-0000-000U05](#) [MLEGRN-A1-0000-000101](#) [MLEGRN-A1-0000-000X02](#) [MLESRD-A1-0000-000W01](#) [XBDAMB-00-0000-000000701](#) [XBDAMB-00-0000-000000801](#)