

# LUXEON Rebel

## General purpose white

The LUXEON Rebel general purpose white line of LEDs are ideal for all lighting and illumination applications. These flux differentiated parts, like all other LUXEON Rebel LEDs, provide the industry's best lumen maintenance, superior reliability and quality white light that make them the most widely used power LEDs today.



### FEATURES AND BENEFITS

- Deliver more usable light and higher flux density
- Optimize applications to reduce size and cost
- Small footprint to tightly pack the LEDs for mixing
- Utilize standard FR4 PCB technology for simplify manufacturing through the use of surface mount technology
- UL-recognized component [E327436]

### PRIMARY APPLICATIONS

- Outdoor
- Specialty

# Table of Contents

General Product Information .....	3
Product Nomenclature .....	3
Average Lumen Maintenance Characteristics .....	3
Environmental Compliance .....	3
Luminous Flux Characteristics .....	4
Flux Performance, Binning, and Supportability .....	4
Optical Characteristics .....	5
Electrical Characteristics .....	6
Absolute Maximum Ratings .....	7
JEDEC Moisture Sensitivity .....	7
Reflow Soldering Characteristics .....	8
Mechanical Dimensions .....	9
Pad Configuration .....	10
Solder Pad Design .....	10
Wavelength Characteristics .....	11
Typical Light Output Characteristics over Temperature .....	12
Typical Forward Current Characteristics .....	13
Typical Relative Luminous Flux .....	14
Current Derating Curves .....	15
Typical Radiation Patterns .....	17
Emitter Pocket Tape Packaging .....	18
Emitter Reel Packaging .....	19
Product Binning and Labeling .....	20
Luminous Flux Bins .....	21
Cool-White Bin Structure .....	22
Neutral-White Bin Structure .....	24
Forward Voltage Bins .....	25

# General Product Information

## Product Nomenclature

LUXEON Rebel is tested and binned at 350 mA, with current pulse duration of 20 ms. All characteristic charts where the thermal pad is kept at constant temperature (25°C typically) are measured with current pulse duration of 20 ms. Under these conditions, junction temperature and thermal pad temperature are the same.

The part number designation is explained as follows:

L X M L - A B C D - E F G H

Where:

- A — designates radiation pattern (value P for Lambertian)
- B — designates color (W = White)
- C — designates tint variant (C = Cool-White or N = Neutral-White)
- D — designates test current (value I for 350 mA)
- E — reserved for future product offerings
- FGH — minimum luminous flux (lm)

Therefore products tested and binned at 350 mA follow the part numbering scheme:

L X M L - P W x I - 0 x x x

## Average Lumen Maintenance Characteristics

Lumen maintenance for solid-state lighting devices (LEDs) is typically defined in terms of the percentage of initial light output remaining after a specified period of time. Lumileds projects that LUXEON Rebel products will deliver, on average, 70% lumen maintenance (L70) at 50,000 hours of operation at a forward current of up to 700 mA. This projection is based on constant current operation with junction temperature maintained at or below 135°C. This performance is based on independent test data, Lumileds historical data from tests run on similar material systems, and internal LUXEON reliability testing. Observation of design limits included in this data sheet is required in order to achieve this projected lumen maintenance.

## Environmental Compliance

Lumileds is committed to providing environmentally friendly products to the solid-state lighting market. LUXEON Rebel is compliant to the European Union directives on the restriction of hazardous substances in electronic equipment, namely the REACH and RoHS directives. Lumileds will not intentionally add the following restricted materials to the LUXEON Rebel: lead, mercury, cadmium, hexavalent chromium, polybrominated biphenyls (PBB) or polybrominated diphenyl ethers (PBDE).

# Luminous Flux Characteristics

## Luminous Flux Characteristics for LUXEON Rebel, Thermal Pad Temperature=25°C

**Table 1.**

Performance at Test Current				Typical Performance at Indicated Current	
Color	Part Number	Minimum Luminous Flux (lm) $\Phi_v^{[1]}$	Test Current (mA)	Typical Luminous Flux (lm) $\Phi_v^{[2]}$	Drive Current (mA)
Cool White	LXML-PWCI-0090	90	350	160	700
	LXML-PWCI-0100	100	350	180	700
	LXML-PWCI-0110	110	350	200	700
	LXML-PWCI-0120	120	350	220	700
Neutral-White	LXML-PWNI-0090	90	350	160	700
	LXML-PWNI-0100	100	350	180	700
	LXML-PWNI-0110	110	350	200	700
	LXML-PWNI-0120	120	350	220	700

Notes for Table 1:

1. Minimum luminous flux performance guaranteed within published operating conditions. Lumileds maintains a tolerance of  $\pm 6.5\%$  on flux measurements.
2. Typical luminous flux performance when device is operated within published operating conditions.

## Flux Performance, Binning, and Supportability

LEDs are produced with semiconductor technology that is subject to process variation, yielding a range of flux performance that is approximately Gaussian in nature. In order to provide customers with fine granularity within the overall flux distribution, Lumileds separates LEDs into fixed, easy to design with, minimum luminous flux bins. To verify supportability of parts chosen for your application design, please consult your Lumileds representative.

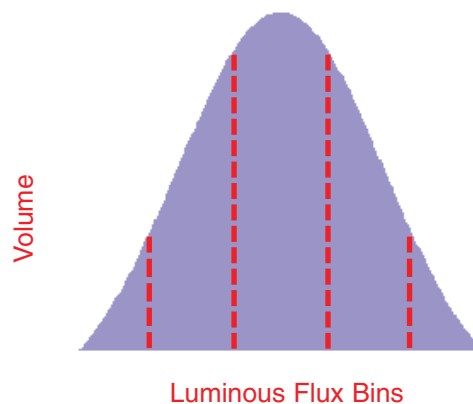

# Optical Characteristics

## Lambertian LUXEON Rebel at Test Current <sup>[1]</sup> Thermal Pad Temperature = 25°C

**Table 2.**

Color <sup>[7,8]</sup>	Color Temperature <sup>[2,3,4]</sup> CCT			Typical Total Included Angle <sup>[6]</sup> (degrees) $\theta_{0.90V}$ <sup>[5]</sup>	Typical Viewing Angle <sup>[7]</sup> (degrees) 2 $\theta$ 1/2
	Min.	Typ.	Max.		
Cool-White	4500K	6500K	10,000K	160	120
Neutral-White	3500K	4100K	4500K	160	120

**Notes for Table 2:**

1. Test current is 350 mA for all LXML-PWxI-0xxx products.
2. CCT  $\pm 5\%$  tester tolerance.
3. Typical CRI (Color Rendering Index) for cool-white and neutral-white is 70.
4. Minimum CRI (Color Rendering Index) for cool-white and neutral-white is 65.
5. Total angle at which 90% of total luminous flux is captured.
6. Viewing angle is the off axis angle from lamp centerline where the luminous intensity is  $\frac{1}{2}$  of the peak value.
7. All white products are built with Indium Gallium Nitride (InGaN).
8. Cool-white and neutral-white power light sources represented here are IEC825 class 2 for eye safety.

# Electrical Characteristics

## Electrical Characteristics at 350 mA for LUXEON Rebel, Part Numbers LXML-PWxI-0xxx, Thermal Pad Temperature = 25°C

**Table 3.**

Color	Forward Voltage $V_f$ [1]			Typical Temperature Coefficient of Forward Voltage [2] $\Delta V_f / \Delta T_j$	Typical Thermal Resistance Junction to Thermal Pad (°C/W) $R\theta_{j-c}$
	Min.	Typ.	Max.		
Cool-White	2.55	3.00	3.99	-2.0 to -4.0	10
Neutral-White	2.55	3.00	3.99	-2.0 to -4.0	10

**Notes for Table 3:**

1. Lumileds maintains a tolerance of  $\pm 0.06V$  on forward voltage measurements.
2. Measured between  $25^\circ C = T_j = 110^\circ C$  at  $I_f = 350$  mA.

## Typical Electrical Characteristics at 700 mA for LUXEON Rebel, Part Numbers LXML-PWxI-0xxx, Thermal Pad Temperature = 25°C [2]

**Table 4.**

Color	Typical Forward Voltage $V_f$ [1] (V)
Cool-White	3.20
Neutral-White	3.20

**Notes for Table 4:**

1. Lumileds maintains a tolerance of  $\pm 0.06V$  on forward voltage measurements.
2. Measured between  $25^\circ C = T_j = 110^\circ C$  at  $I_f = 700$  mA.

## Absolute Maximum Ratings

**Table 5.**

Parameter	Cool-White/Neutral-White
DC Forward Current (mA)	1000
Peak Pulsed Forward Current (mA)	1000
Average Forward Current (mA)	1000
ESD Sensitivity	< 8000V Human Body Model (HBM) Class 2 JESD22-A114-B < 400V Machine Model (MM) Class 2 JESD22-A115-B
LED Junction Temperature <sup>[1]</sup>	150°C
Operating Case Temperature at 350 mA	-40°C - 135°C
Storage Temperature	-40°C - 135°C
Soldering Temperature	JEDEC 020c 260°C
Allowable Reflow Cycles	3
Autoclave Conditions	121°C at 2 ATM 100% Relative Humidity for 96 Hours Maximum
Reverse Voltage (Vr)	See Note 2

**Notes for Table 5:**

1. Proper current derating must be observed to maintain junction temperature below the maximum.
2. LUXEON Rebel LEDs are not designed to be driven in reverse bias.

## JEDEC Moisture Sensitivity

**Table 6.**

Level	Soak Requirements			
	Floor Life		Standard	
	Time	Conditions	Time	Conditions
1	unlimited	≤ 30°C / 85% RH	168h + 5 / -0	85°C / 85% RH

# Reflow Soldering Characteristics

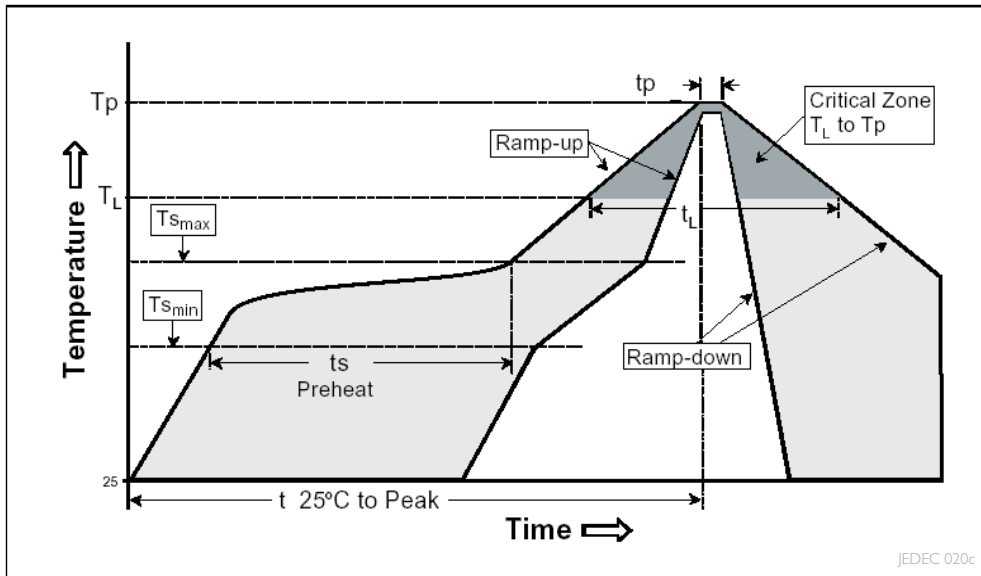

Table 7.

Profile Feature	Lead Free Assembly
Ramp-Up Rate ( $T_L$ to $T_p$ )	3°C / second max
Preheat Temperature Min ( $T_{s_{min}}$ )	150°C
Preheat Temperature Max ( $T_{s_{max}}$ )	200°C
Preheat Time ( $t_{s_{min}}$ to $t_{s_{max}}$ )	60 - 180 seconds
Temperature ( $T_L$ )	217°C
Time Maintained Above Temperature $T_L$ ( $t_L$ )	60 - 150 seconds
Peak / Classification Temperature ( $T_p$ )	260°C
Time Within 5°C of Actual Peak Temperature ( $t_p$ )	20 - 40 seconds
Ramp-Down Rate ( $T_p$ to $T_L$ )	6°C / second max
Time 25°C to Peak Temperature	8 minutes max

Notes for Table 7:

- All temperatures refer to the application Printed Circuit Board (PCB), measured on the surface adjacent to the package body.



# Mechanical Dimensions

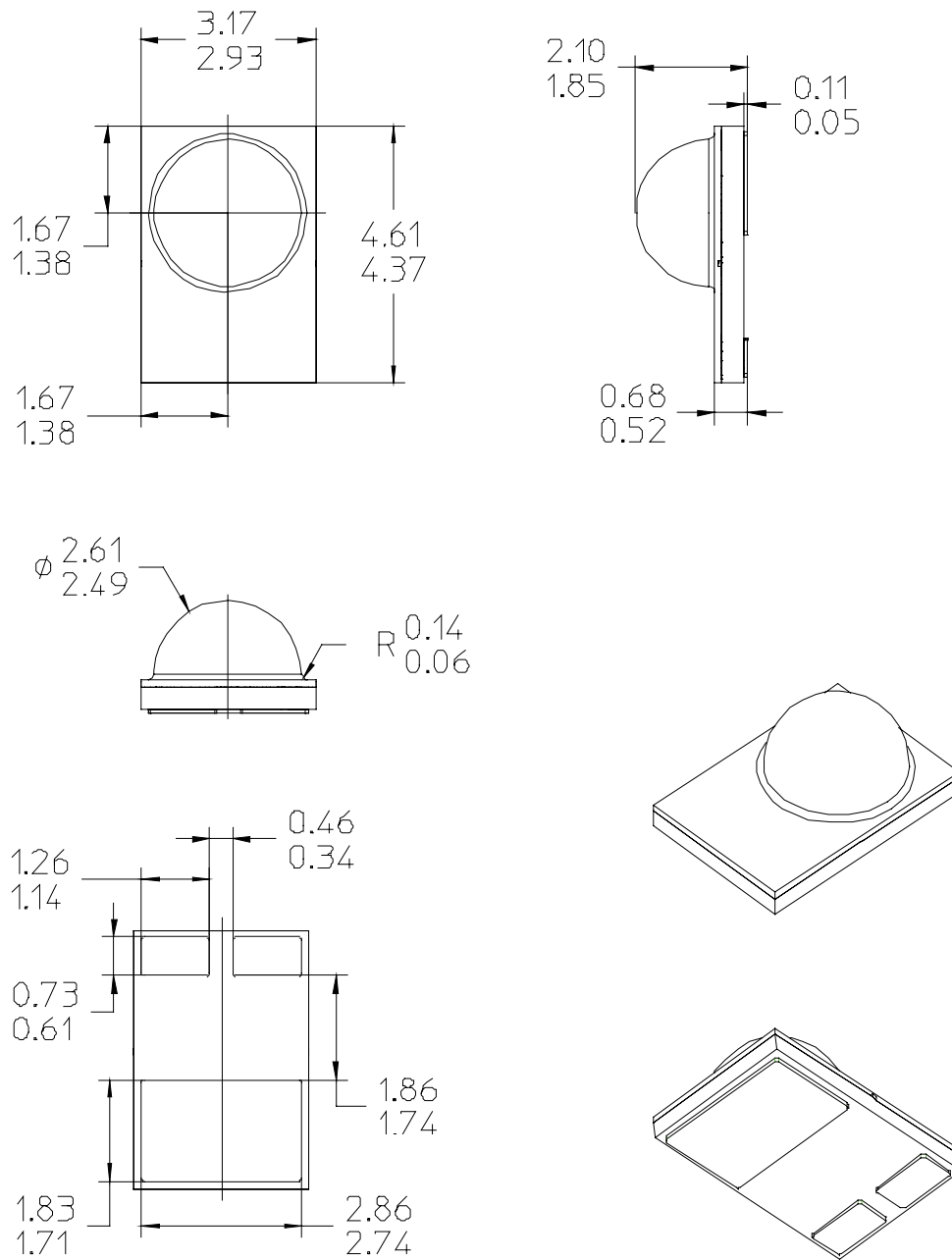
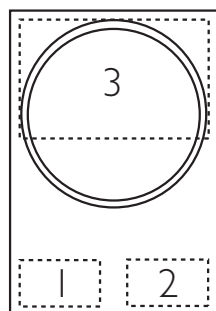

Figure 1. Package outline drawing.

## Notes for Figure 1:

- Do not handle the device by the lens—care must be taken to avoid damage to the lens or the interior of the device that can be damaged by excessive force to the lens.
- Drawings not to scale.
- All dimensions are in millimeters.
- The Thermal Pad is electrically isolated from the Anode and Cathode contact pads.

# Pad Configuration



TOP

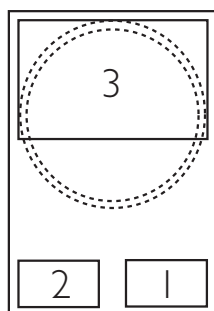

BOTTOM

PAD	FUNCTION
1	CATHODE
2	ANODE
3	THERMAL

Figure 2. Pad configuration.

Note for Figure 2:

- The Thermal Pad is electrically isolated from the Anode and Cathode contact pads.

## Solder Pad Design

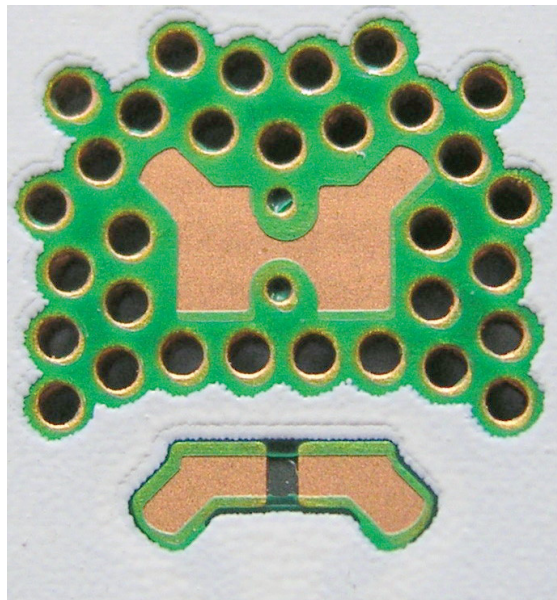

Figure 3. Solder pad layout.

Note for Figure 3:

- The photograph below shows the recommended LUXEON Rebel layout on Printed Circuit Board (PCB). This design easily achieves a thermal resistance of 7K/W.
- Application Brief AB32 provides extensive details for this layout. In addition, the .dwg files are available at [www.lumileds.com](http://www.lumileds.com).

# Wavelength Characteristics

## Cool-White at Test Current

Thermal Pad Temperature = 25°C

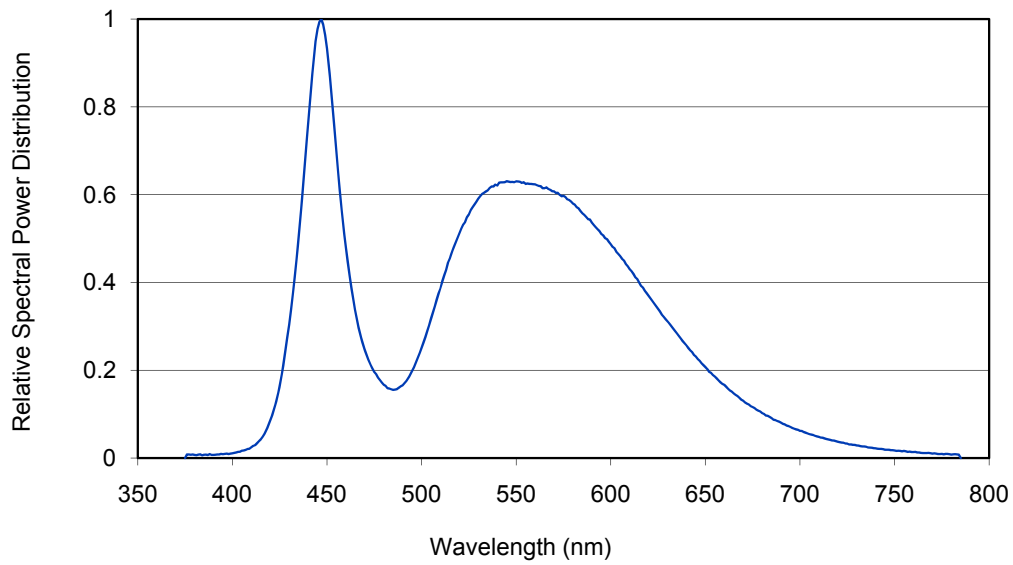

Figure 4a. Cool-white color spectrum of typical CCT part, integrated measurement

## Neutral-White at Test Current

Thermal Pad Temperature = 25°C

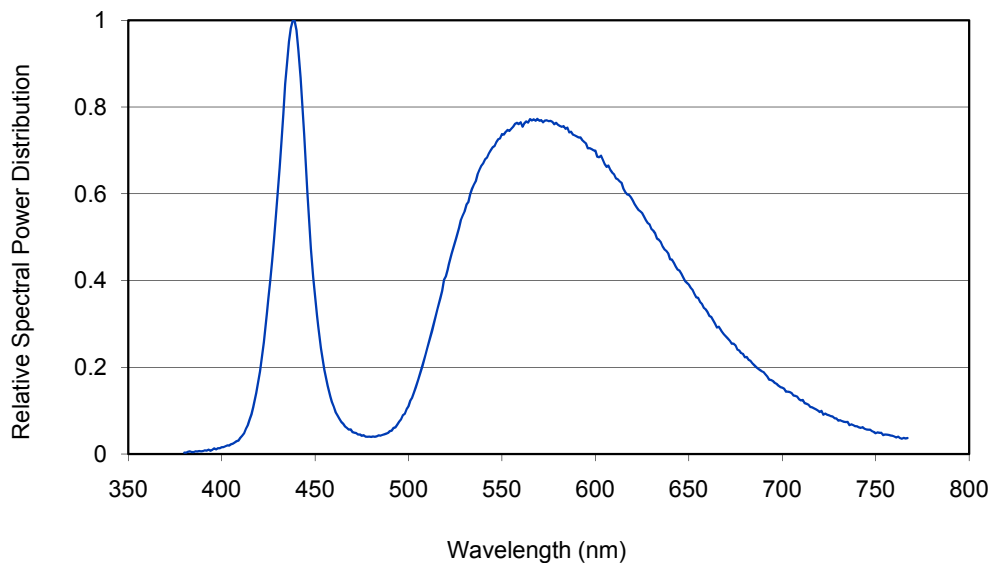
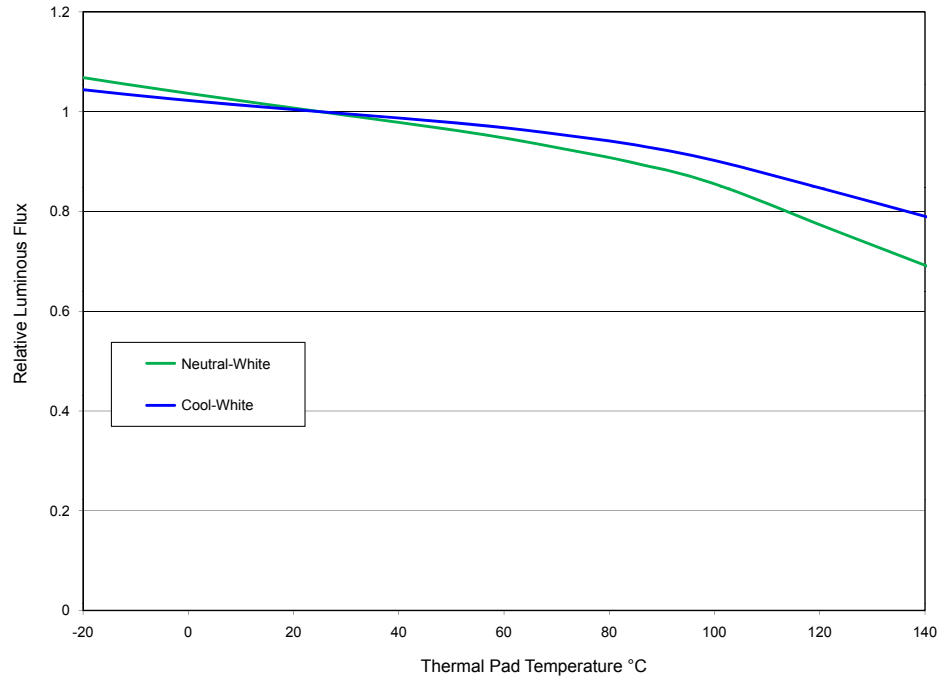

Figure 4b. Neutral-white color spectrum of typical CCT part, integrated measurement.

# Typical Light Output Characteristics over Temperature

## Cool-White and Neutral-White at Test Current



**Figure 5. Relative luminous flux vs. thermal pad temperature.**

# Typical Forward Current Characteristics

Cool-White and Neutral-White  
Thermal Pad Temperature = 25°C

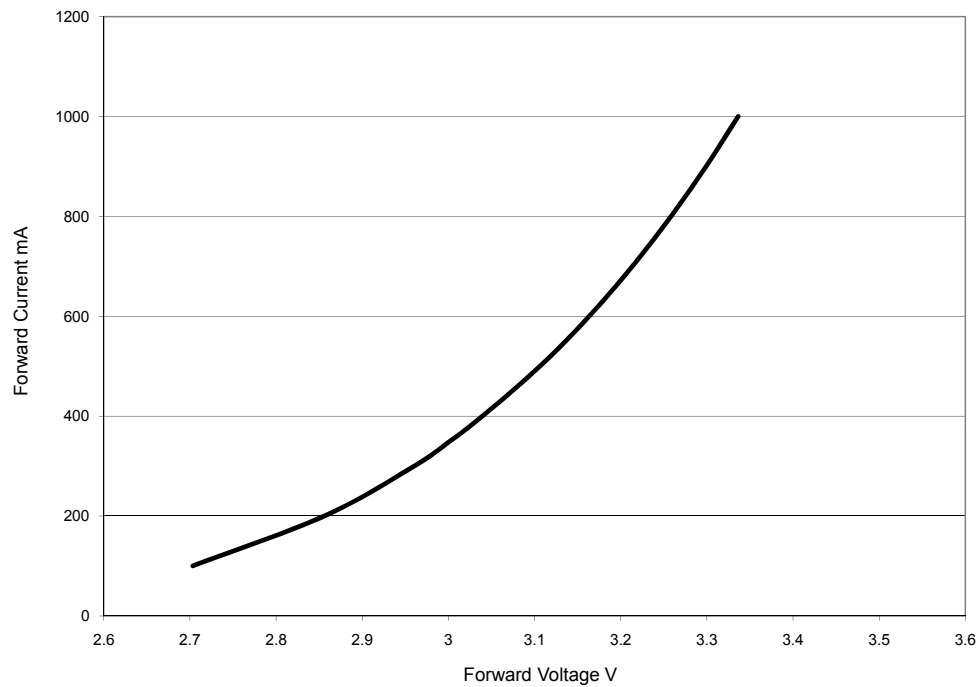
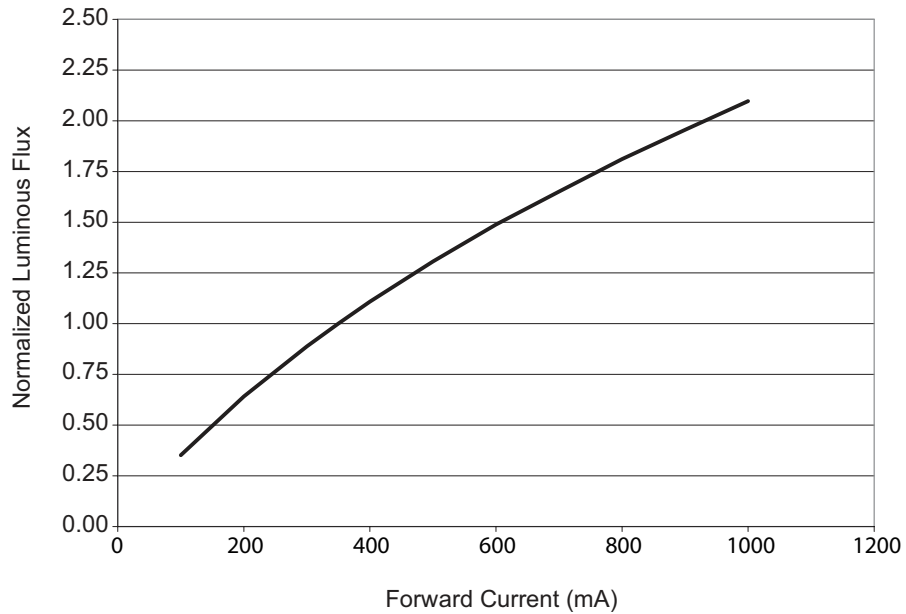

Figure 6. Forward current vs. forward voltage.

# Typical Relative Luminous Flux

## Typical Relative Luminous Flux vs. Forward Current for Cool-White and Neutral-White Thermal Pad Temperature = 25°C



**Figure 7. Relative luminous flux or radiometric power vs. forward current for cool-white and neutral-white, Thermal Pad = 25°C maintained.**

# Current Derating Curves

## Current Derating Curve for 350 mA Drive Current Cool-White and Neutral-White

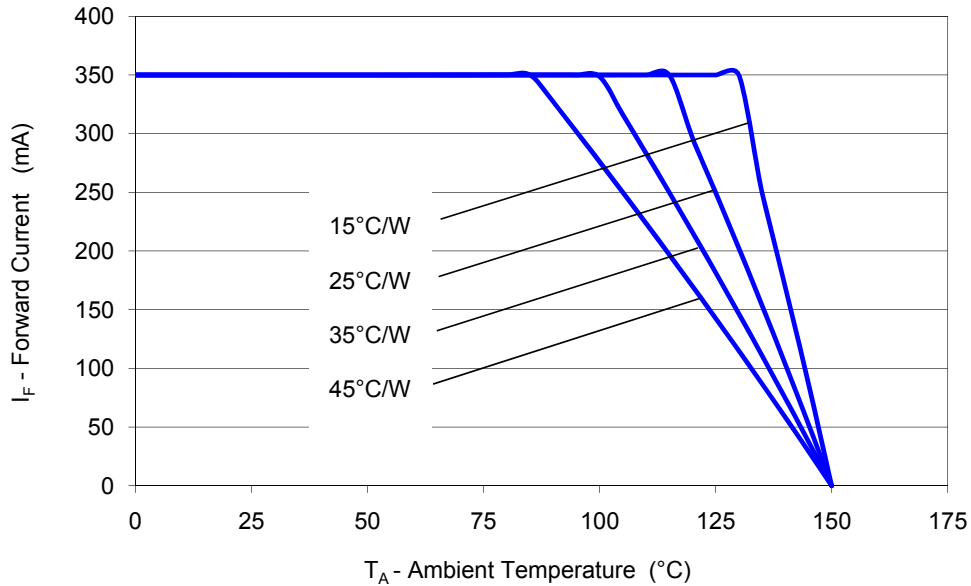

Figure 8. Maximum forward current vs. ambient temperature, based on  $T_{JMAX} = 150^\circ\text{C}$ .

## Current Derating Curve for 700 mA Drive Current Cool-White and Neutral-White

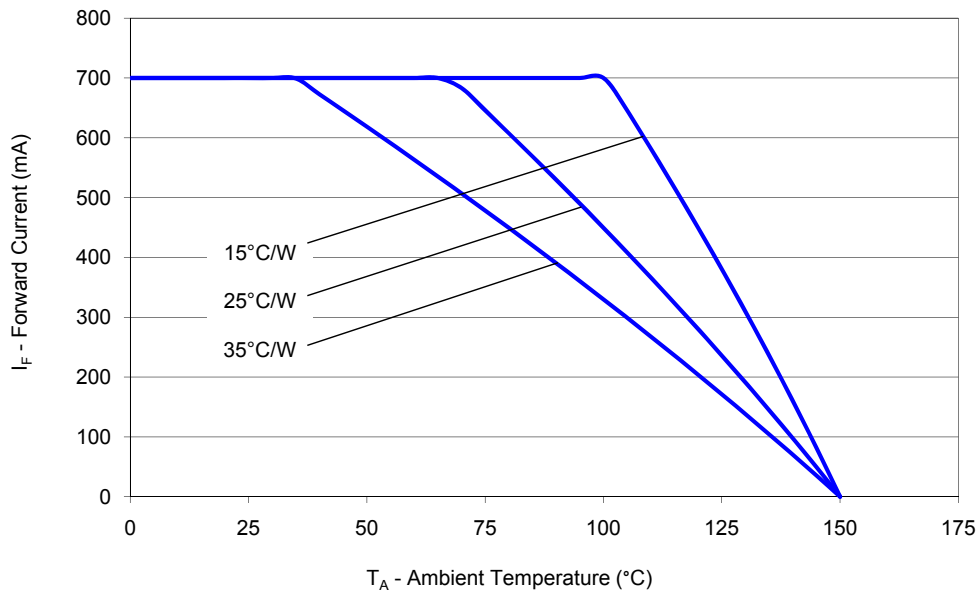

Figure 9. Maximum forward current vs. ambient temperature, based on  $T_{JMAX} = 150^\circ\text{C}$ .

I. Current derating curves represent constant current operation condition.

## Current Derating Curve for 1000 mA Drive Current Cool-White and Neutral-White

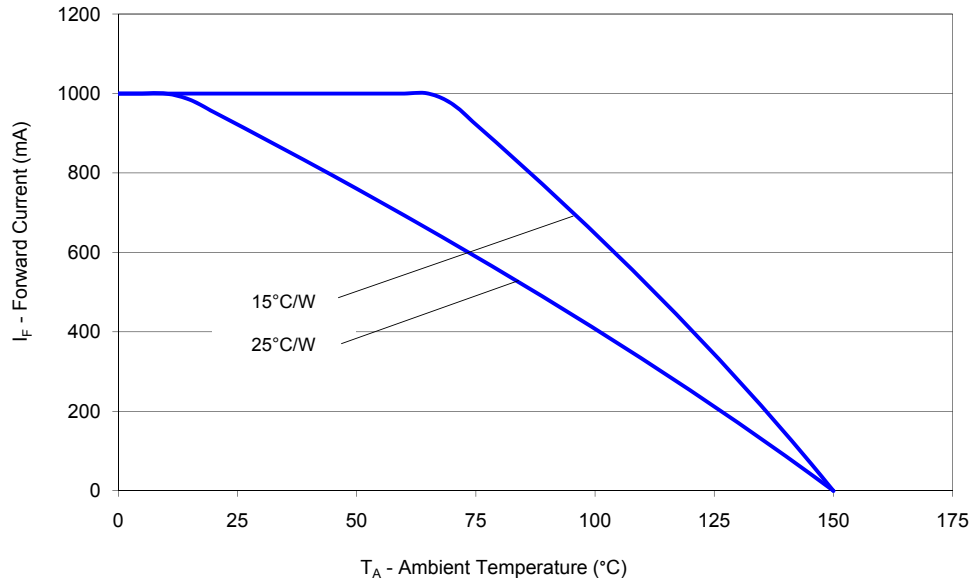

Figure 10. Maximum forward current vs. ambient temperature, based on  $T_{JMAX} = 150^{\circ}\text{C}$ .



# Typical Radiation Patterns

## Typical Spatial Radiation Pattern for Cool-White and Neutral-White Lambertian

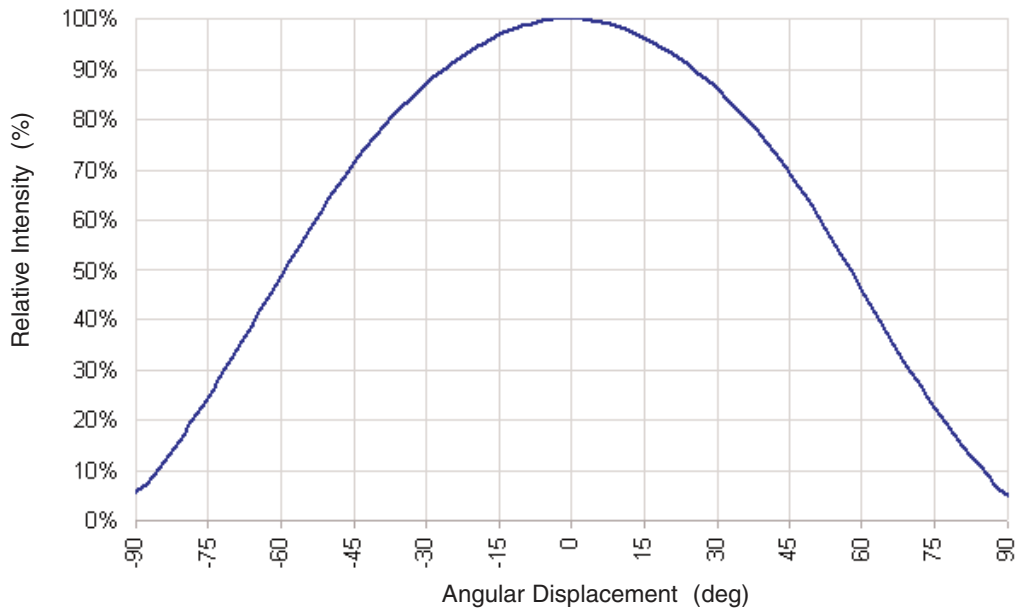

Figure 11a. Typical representative spatial radiation pattern for cool-white and neutral-white lambertian.

## Typical Polar Radiation Pattern for White Lambertian

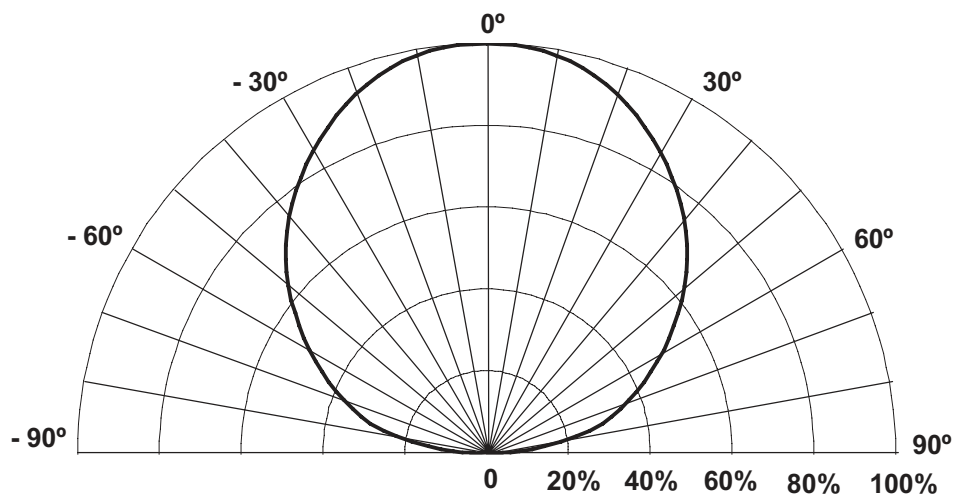

Figure 11b. Typical polar radiation pattern for cool-white and neutral-white lambertian.

# Emitter Pocket Tape Packaging

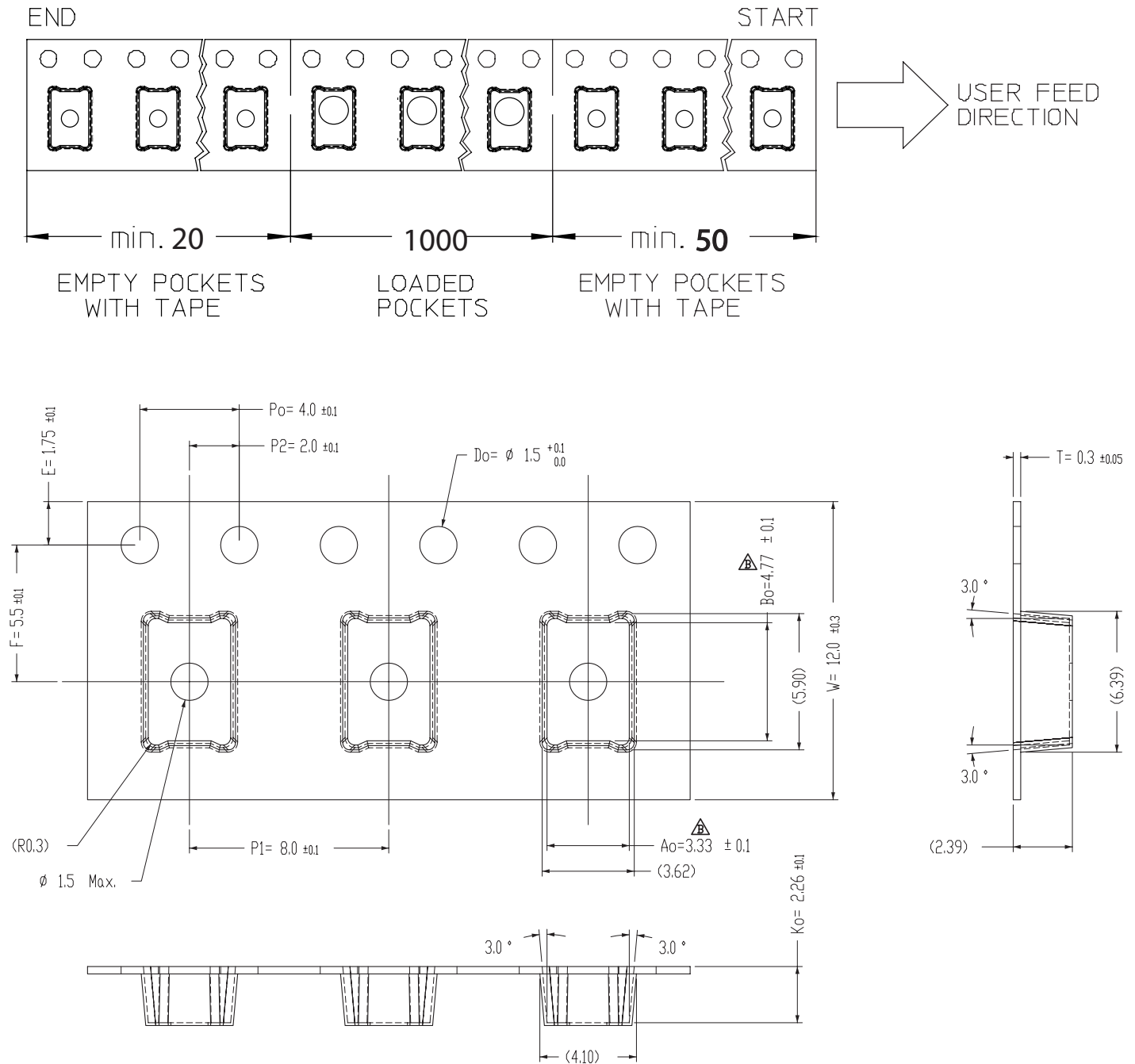

Figure 13. Emitter pocket tape packaging

# Emitter Reel Packaging

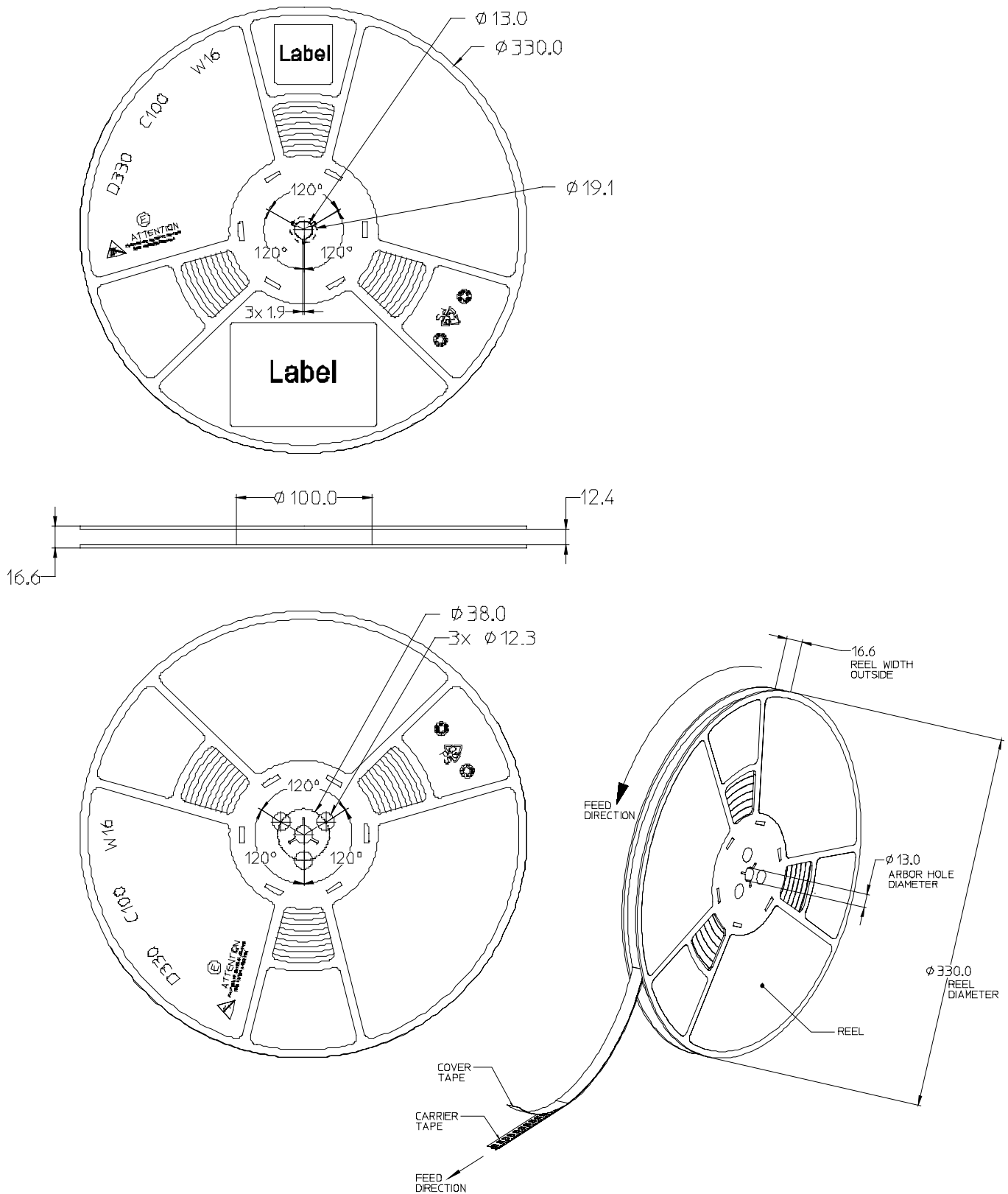

Figure 14. Emitter reel packaging

# Product Binning and Labeling

## **Purpose of Product Binning**

In the manufacturing of semiconductor products, there is a variation of performance around the average values given in the technical data sheets. For this reason, Lumileds bins the LED components for luminous flux, color and forward voltage ( $V_f$ ).

## **Decoding Product Bin Labeling**

LUXEON Rebel emitters are labeled using a three or four digit alphanumeric code (CAT code) depicting the bin values for emitters packaged on a single reel. All emitters packaged within a reel are of the same 3-variable bin combination. Using these codes, it is possible to determine optimum mixing and matching of products for consistency in a given application.

Reels of Cool-White and Neutral-White emitters are labeled with a four digit alphanumeric CAT code following the format below.

ABCD

A = Flux bin (J, K, L, M etc.)

B and C = Color bin (W0, U0, V0 etc.)

D =  $V_f$  bin (D, E, F, G etc.)

# Luminous Flux Bins

Table 8 lists the standard photometric luminous flux bins for LUXEON Rebel emitters (tested and binned at 350 mA).

Although several bins are outlined, product availability in a particular bin varies by production run and by product performance. Not all bins are available in all colors.

Table 8.

## Flux Bins

Bin Code	Minimum Photometric Flux (lm)	Maximum Photometric Flux (lm)
H	50	60
J	60	70
K	70	80
L	80	90
M	90	100
N	100	110
X	110	120
P	120	130
Y	130	140
Q	140	150
R	150	160

# Cool-White Bin Structure

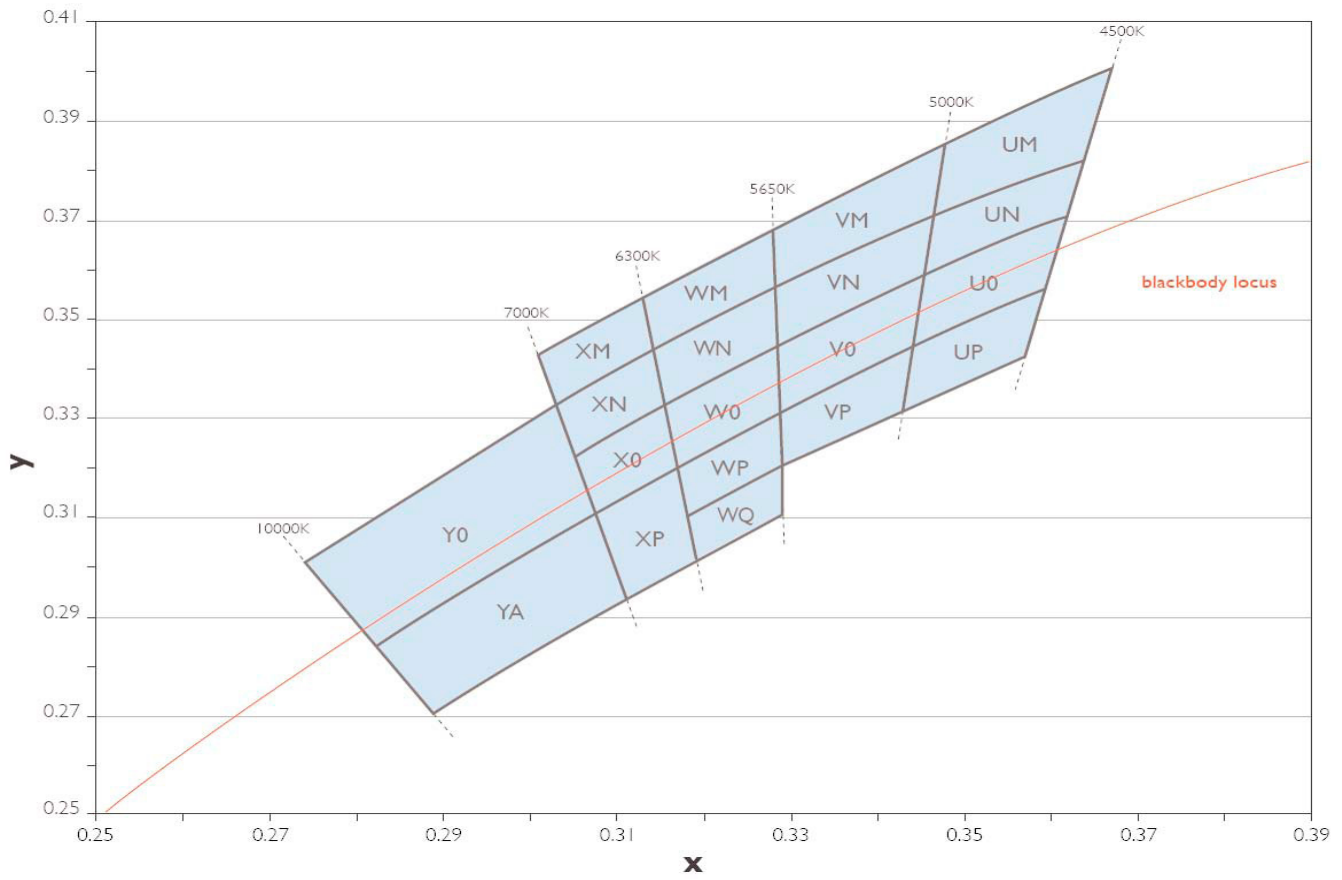

Figure 15. Cool-White bin structure.

Cool-White LUXEON Rebel emitters are tested and binned by x,y coordinates. 19 Color Bins, CCT Range 4,500K to 10,000K.

**Table 9.**

Cool-White Bin Coordinates							
Bin Code	X	Y	Typical CCT (K)	Bin Code	X	Y	Typical CCT (K)
Y0	0.274238	0.300667	8000	WQ	0.318606	0.310201	6000
	0.303051	0.332708			0.329393	0.320211	
	0.307553	0.310778			0.329544	0.310495	
	0.282968	0.283772			0.319597	0.301303	
YA	0.282968	0.283772	8000	VM	0.328636	0.368952	5300
	0.307553	0.310778			0.348147	0.385629	
	0.311163	0.293192			0.346904	0.371742	
	0.289922	0.270316			0.328823	0.356917	
XM	0.301093	0.342244	6700	VN	0.328823	0.356917	5300
	0.313617	0.354992			0.346904	0.371742	
	0.314792	0.344438			0.345781	0.359190	
	0.303051	0.332708			0.329006	0.345092	
XN	0.303051	0.332708	6700	VO	0.329006	0.345092	5300
	0.314792	0.344438			0.345781	0.359190	
	0.316042	0.333222			0.344443	0.344232	
	0.305170	0.322386			0.329220	0.331331	
X0	0.305170	0.322386	6700	VP	0.329220	0.331331	5300
	0.316042	0.333222			0.344443	0.344232	
	0.317466	0.320438			0.343352	0.332034	
	0.307553	0.310778			0.329393	0.320211	
XP	0.307553	0.310778	6700	UM	0.348147	0.385629	4750
	0.317466	0.320438			0.367294	0.400290	
	0.319597	0.301303			0.364212	0.382878	
	0.311163	0.293192			0.346904	0.371742	
WM	0.313617	0.354992	6000	UN	0.346904	0.371742	4750
	0.328636	0.368952			0.364212	0.382878	
	0.328823	0.356917			0.362219	0.371616	
	0.314792	0.344438			0.345781	0.359190	
WN	0.314792	0.344438	6000	U0	0.345781	0.359190	4750
	0.328823	0.356917			0.362219	0.371616	
	0.329006	0.345092			0.359401	0.355699	
	0.316042	0.333222			0.344443	0.344232	
W0	0.316042	0.333222	6000	UP	0.344443	0.344232	4750
	0.329006	0.345092			0.359401	0.355699	
	0.329220	0.331331			0.357079	0.342581	
	0.317466	0.320438			0.343352	0.332034	
WP	0.317466	0.320438	6000				
	0.329220	0.331331					
	0.329393	0.320211					
	0.318606	0.310201					

Note for Table 9:

- Lumileds maintains a tester tolerance of  $\pm 0.005$  on x, y color coordinates.

# Neutral-White Bin Structure

Neutral-White LUXEON Rebel emitters are tested and binned by x,y coordinates. 12 Color Bins, CCT Range 3,500K to 4,500K.

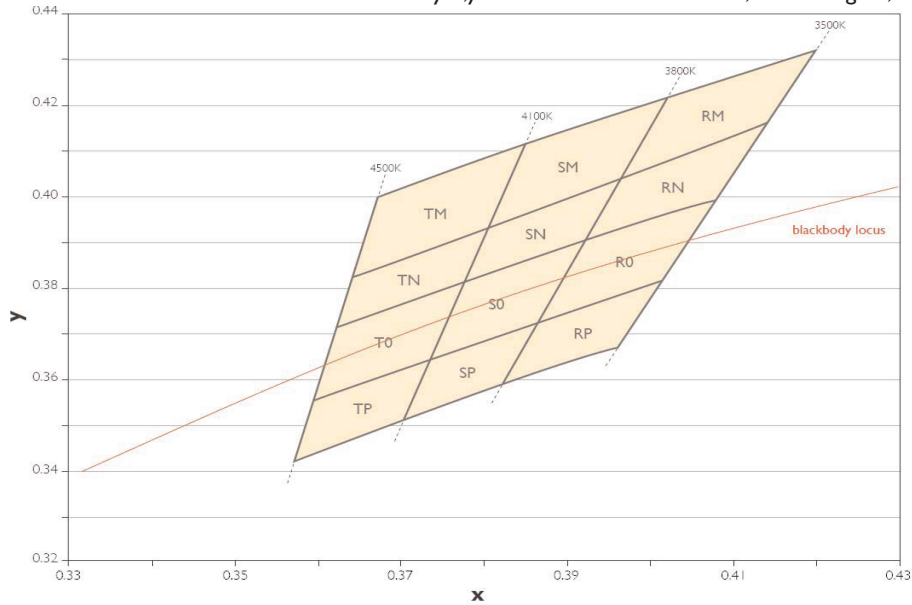

Figure 16. Neutral-White bin structure.

Table 10.

Neutral-White Bin Coordinates

Bin Code	X	Y	Typical CCT (K)	Bin Code	X	Y	Typical CCT (K)
TM	0.367294	0.400290	4300	S0	0.378264	0.382458	3950
	0.385953	0.412995			0.392368	0.390932	
	0.381106	0.393747			0.387071	0.373899	
	0.364212	0.382878			0.374075	0.365822	
TN	0.364212	0.382878	4300	SP	0.374075	0.365822	3950
	0.381106	0.393747			0.387071	0.373899	
	0.378264	0.382458			0.382598	0.359515	
	0.362219	0.371616			0.370582	0.351953	
T0	0.362219	0.371616	4300	RM	0.402270	0.422776	3650
	0.378264	0.382458			0.420940	0.432618	
	0.374075	0.365822			0.414776	0.416097	
	0.359401	0.355699			0.396279	0.403508	
TP	0.359401	0.355699	4300	RN	0.396279	0.403508	3650
	0.374075	0.365822			0.414776	0.416097	
	0.370582	0.351953			0.408593	0.399525	
	0.357079	0.342581			0.392368	0.390932	
SM	0.385953	0.412995	3950	R0	0.392368	0.390932	3650
	0.402270	0.422776			0.408593	0.399525	
	0.396279	0.403508			0.402113	0.382156	
	0.381106	0.393747			0.387071	0.373899	
SN	0.381106	0.393747	3950	RP	0.387071	0.373899	3650
	0.396279	0.403508			0.402113	0.382156	
	0.392368	0.390932			0.396564	0.367284	
	0.378264	0.382458			0.382598	0.359515	

Note for Table 10:

- Lumileds maintains a tester tolerance of  $\pm 0.005$  on x,y color coordinates.



# Forward Voltage Bins

Table II lists minimum and maximum  $V_f$  bin values per emitter. Although several bins are outlined, product availability in a particular bin varies by production run and by product performance.

**Table II.**

$V_f$ Bins		
Bin Code	Minimum Forward Voltage (V)	Maximum Forward Voltage (V)
B	2.55	2.79
C	2.79	3.03
D	3.03	3.27
E	3.27	3.51
F	3.51	3.75
G	3.75	3.99

# About Lumileds

Lumileds is the global leader in light engine technology. The company develops, manufactures and distributes groundbreaking LEDs and automotive lighting products that shatter the status quo and help customers gain and maintain a competitive edge.

With a rich history of industry “firsts,” Lumileds is uniquely positioned to deliver lighting advancements well into the future by maintaining an unwavering focus on quality, innovation and reliability.

To learn more about our portfolio of light engines, visit [lumileds.com](http://lumileds.com).



---

©2016 Lumileds Holding B.V. All rights reserved.  
LUXEON is a registered trademark of the Lumileds Holding B.V.  
in the United States and other countries.  
[lumileds.com](http://lumileds.com)

Lumileds Holding B.V. shall not be liable for any kind of loss of data or any other damages, direct, indirect or consequential, resulting from the use of the provided information and data. Although Lumileds Holding B.V. has attempted to provide the most accurate information and data, the materials and services information and data are provided “as is” and Lumileds Holding B.V. neither warranties, nor guarantees the contents and correctness of the provided information and data. Lumileds Holding B.V. reserves the right to make changes without notice. You as user agree to this disclaimer and user agreement with the download or use of the provided materials, information and data.

## X-ON Electronics

Largest Supplier of Electrical and Electronic Components

*Click to view similar products for [High Power LEDs - White category](#):*

*Click to view products by [Lumileds manufacturer](#):*

Other Similar products are found below :

[LTW-K140SZR40](#) [B42180-08](#) [STW8Q2PA-R5-HA](#) [LTPL-P00DWS57](#) [LTW-K140SZR30](#) [LZP-D0WW00-0000](#) [SZ5-M1-WW-C8-V1/V3-FA](#) [LTW-K140SZR57](#) [LTW-K140SZR27](#) [BXRE-50C2001-C-74](#) [MP-5050-8100-27-80](#) [MP-5050-6100-65-80](#) [MP-5050-6100-40-80](#) [MP-5050-6100-30-80](#) [KW DPLS32.SB-6H6J-E5P7-EG-Z264](#) [L1V1-507003V500000](#) [KW DMLS33.SG-Z6M7-EBVFFCBB46-8E8G-700-S](#) [ASMT-MW05-NMNS1](#) [KW DPLS33.KD-HIJG-D30D144-HN-22C2-120-S](#) [KW DDLM31.EH-5J6K-A737-W4A4-140-R18](#) [GW](#) [JTLRS1.CM-K1LW-XX57-1-100-Q-R33](#) [KW DDLM31.EH-5J6K-A636-W4A4-140-R18](#) [KW DDLM31.EH-5J6K-A131-W4A4-140-R18](#) [SML-LXL8047MWCTR/3](#) [L2C5-40HG1203E0900](#) [JB3030AWT-P-U27EA0000-N0000001](#) [JK3030AWT-P-U30EA0000-N0000001](#) [JK3030AWT-P-B40EB0000-N0000001](#) [JK3030AWT-P-H30EB0000-N0000001](#) [JK3030AWT-P-H40EB0000-N0000001](#) [JK3030AWT-P-U27EB0000-N0000001](#) [JK3030AWT-P-U30EB0000-N0000001](#) [XPGBWT-HE-0000-00JE5](#) [GW JCLPS2.EM-H3H8-A131-1-65-2-R33](#) [GW](#) [PUSTA1.PM-PAPC-XX53-1-1050-R18](#) [BXRE-30E4000-C-83](#) [BXRE-50C6501-D-84](#) [BXRE-27E1000-B-83](#) [BXRE-30G0800-D-83](#) [BXRE-50C4001-B-84](#) [BXRH-40E4000-F-83](#) [BXRH-27G4000-F-83](#) [BXRE-27E4000-B-83](#) [BXRE-27E4000-C-83](#) [BXRE-27G30H0-D-82](#) [BXRE-27G4000-B-83](#) [BXRE-40E1000-B-83](#) [BXRE-40E6500-D-83](#) [BXRH-27E1000-B-83](#) [BXRH-27E4000-F-83](#)